

pui
audio™ inc
a projects unlimited company

AS01508MR-R 15mm Speaker



3541 Stop Eight Road • Dayton, Ohio 45414

Product Overview

- 15mm overall diameter speaker with Neodymium magnet for 88 dB sensitivity
- 1.2W continuous, 1.8W maximum power handling and 8Ω impedance
- Mylar cone, integrated grill screen, and pre-applied double-sided tape for quick mounting

Frequency Response (0.1W @ 0.1 meter)

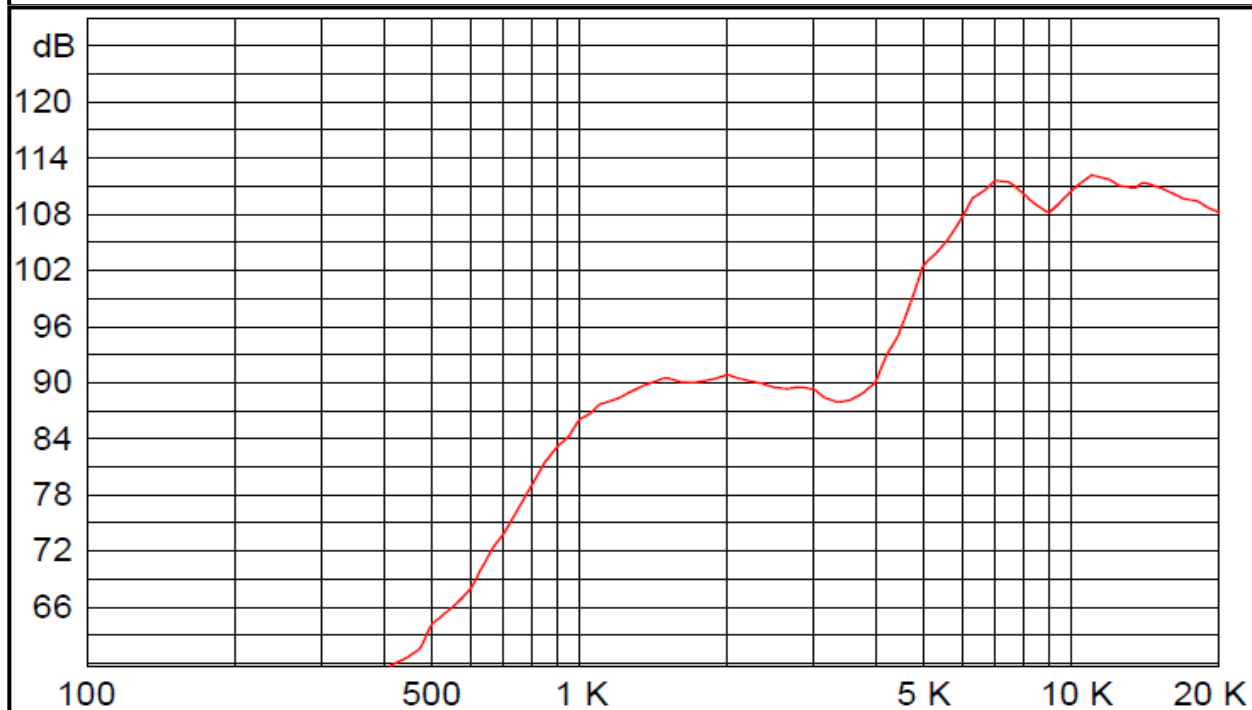

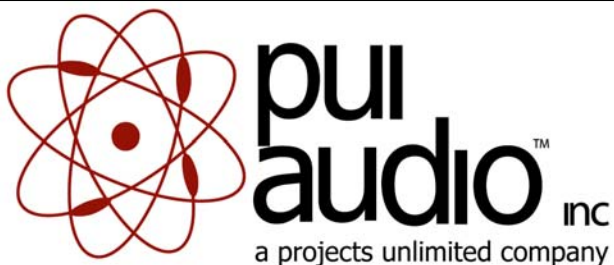

AS01508MR-R 15mm Speaker

Mechanical and Environment Testing	
Test Description	Test Condition
High Temperature	85°C with random humidity for 96 hours
Low Temperature	-40°C with random humidity for 96 hours
Humidity	40°C \pm 2°C with 90% to 95% relative humidity for 96 hours
Vibration	1.5 mm movement modulated at 10 to 55 Hz for 2 hours
Drop Test	75 cm free fall onto 5 mm thick board, 10 cycles
Temperature Cycle Test	-20°C to 55°C, 5 cycles (refer to Temperature Cycle Test Graph)

After tests, speaker shall rest for 1 hours. SPL shall not deviate \pm 3 dB from pre-test measurement.

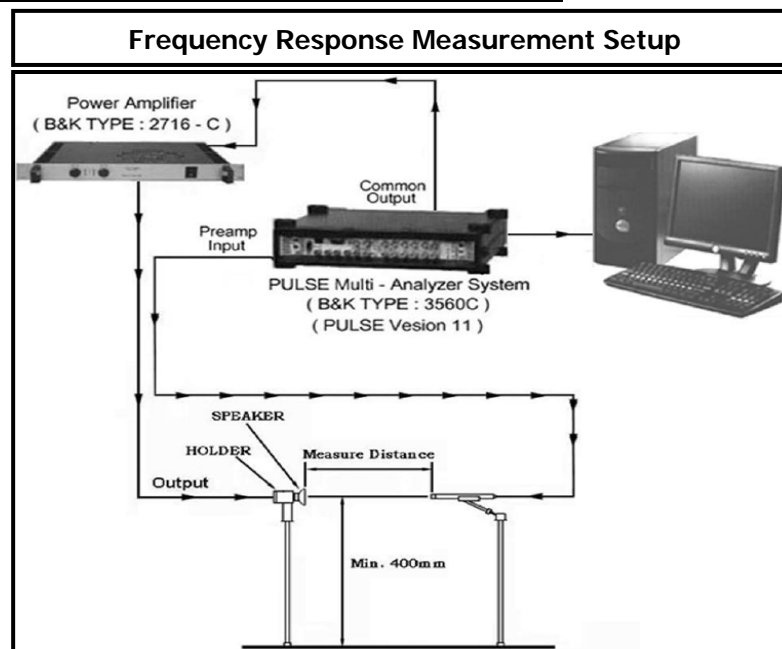
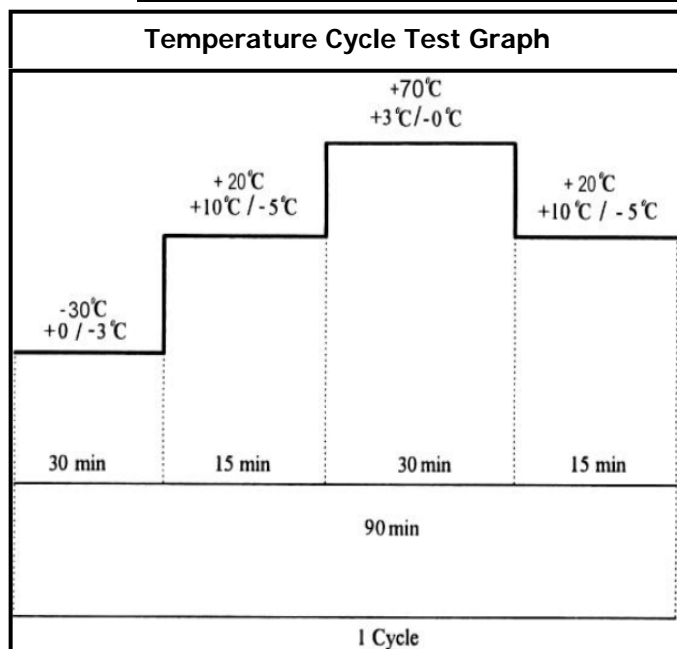

SPECIFICATIONS

PARAMETERS	VALUES	UNITS
RATED INPUT POWER	1.2	W
MAX INPUT POWER	1.8	W
IMPEDANCE	8 ± 15%	OHM
OUTPUT SPL @ 0.1W/0.1M (AT 0.8, 1.0, 1.2, 1.5, 2.0 kHz)	88 ± 3	dB(A)
DISTORTION (MAX.)	10%	-
RESONANT FREQUENCY	900 ± 20%	Hz
FREQUENCY RANGE	900 ~ 12,000	Hz
HOUSING MATERIAL	ABS	-
CONE MATERIAL	MYLAR	-
MAGNET MATERIAL	Nd-Fe-B	-
OPERATING TEMPERATURE	-30 ~ +70	°C
WEIGHT	1.5	grams

THIS DOCUMENT CONTAINS DATA PROPRIETARY TO PROJECTS UNLIMITED, INC. ANY USE OR REPRODUCTION, IN ANY FORM, WITHOUT PRIOR WRITTEN PERMISSION OF PROJECTS UNLIMITED, INC. IS PROHIBITED.
©2003, Projects Unlimited Inc.

REVISION HISTORY

LTR	DESCRIPTION	DATE	APPROVED
-	RELEASED FROM ENGINEERING	12/31/2007	
A	REVISED HEIGHT DIMENSIONS	2/05/2009	B.R.
B	REVISED TO INVENTOR 3-D DRAWING TEMPLATE	2/06/2009	B.R.

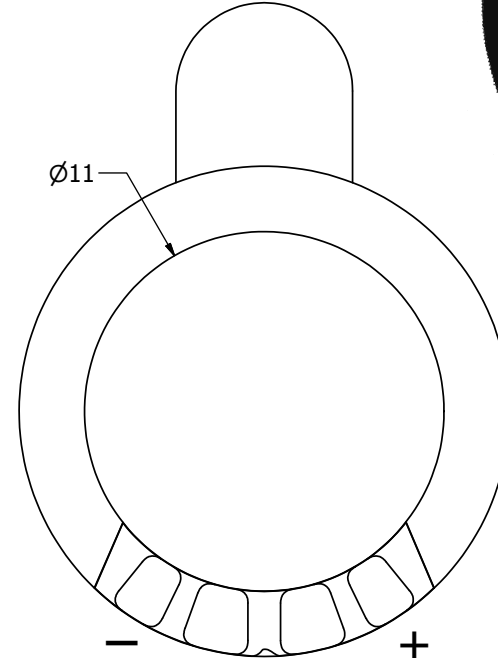
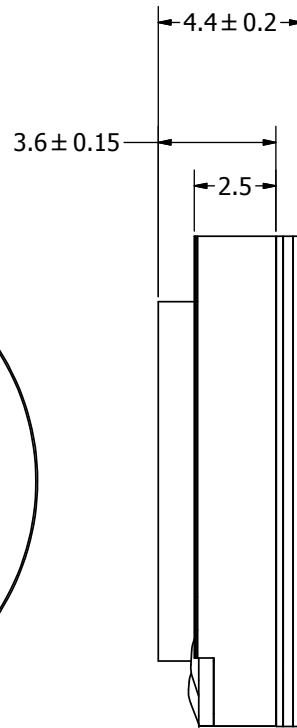
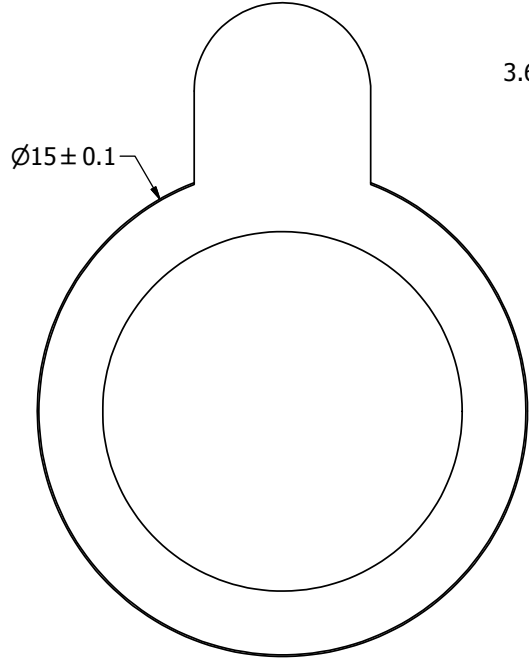

NOTES:

1. ALL DIMENSIONS ARE IN MILLIMETERS.
2. SPECIFICATIONS SUBJECT TO CHANGE OR WITHDRAWAL WITHOUT NOTICE.
3. THIS PART IS RoHS 2002/95/EC COMPLIANT.

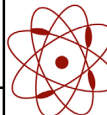
UNLESS OTHERWISE SPECIFIED: DIMENSIONS ARE IN MILLIMETERS, TOLERANCES ARE ±0.5 AND ANGLES ARE ±3°.	SIZE	Designed by	Date	Checked by	Date	Approved by	Date	Drawn Date
	A3	J.D.	9/5/2006	B.R.	9/5/2006	R.W.	9/5/2006	2/6/2009
AS01508MR-R.idw	 pui audio a projects unlimited company		AS01508MR-R			Speaker	Edition	Sheet
						-		1 / 1

X-ON Electronics

Largest Supplier of Electrical and Electronic Components

Click to view similar products for [Speakers & Transducers](#) category:

Click to view products by [PUI Audio](#) manufacturer:

Other Similar products are found below :

[FC-30814-P127](#) [AS02832MR-2-R](#) [PB-1220PE](#) [PB-2015PQ](#) [900-00001](#) [AB2025B-LW50-R](#) [SWFK-31736-000](#) [PT-2065FW](#) [PT-4175W](#) [AT-2830-TW-LW35-R](#) [ED-30761-000](#) [CI-30120-A42](#) [SMT-0440-T-2-R](#) [PB-0927PQ](#) [BF-7083-000](#) [BF-9778-000](#) [MBS 3000-1811-A1AB08-0](#) [SMS2020-08H4.5 LF](#) [BDT1717-08H6.5W56MLF](#) [02094](#) [02097](#) [GSPK1003PN-8R0.2W-L100](#) [GSPK151103TN-8R0.2W](#) [GSPK2014035PN-8R0.5W-L100](#) [FS5353DS0830-H19.3](#) [TE082703-8](#) [XMLP040BD21F](#) [AS03608MR-LW100-R](#) [24520](#) [SMT-0540-S-2-R](#) [1450069](#) [9091653](#) [9091661](#) [IPS-G6000-5](#) [9090231](#) [FS4014-4-2W](#) [PBM4-13.B31R.A115.0663](#) [PBM4-13.B33R.A115.0663](#) [PBM4-13.B35R.A115.0663](#) [A-10-6-BG360-HD1Z-GA-M4Z-ZW](#) [A-10-6-BG410-HD1Z-AA-AGZ-ZW](#) [A-10-6-BG410-HD1Z-AA-M4Z-ZW](#) [A-10-6-BG410-HD1Z-FC-AGZ-ZW](#) [A-10-6-BG410-HD1Z-GA-M4Z-ZW](#) [A-10-6-BG310-HD1Z-AA-AGZ-ZW](#) [A-10-6-BG310-HD1Z-AA-M4Z-ZW](#) [A-10-6-BG310-HD1Z-GA-M4Z-ZW](#) [A-10-6-BG316-HD1Z-AA-AGZ-ZW](#) [A-10-6-BG316-HD1Z-AA-M4Z-ZW](#) [A-10-6-BG325-HD1Z-AA-AGZ-ZW](#)