

**pui  
audio**™ inc  
a projects unlimited company

## ASE06008MR-LW150-R 60mm Enclosed Speaker

3541 Stop Eight Road • Dayton, Ohio 45414

### Product Overview

- 60 x 30mm speaker with 150mm lead wires for instant integration
- 3W continuous, 4 maximum power handling and 8Ω impedance
- Rugged ABS enclosure designed for optimum sound

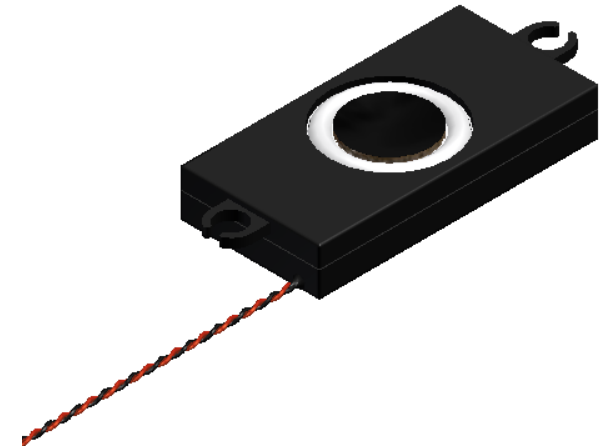

Frequency Response (1W @ 0.5 meters)

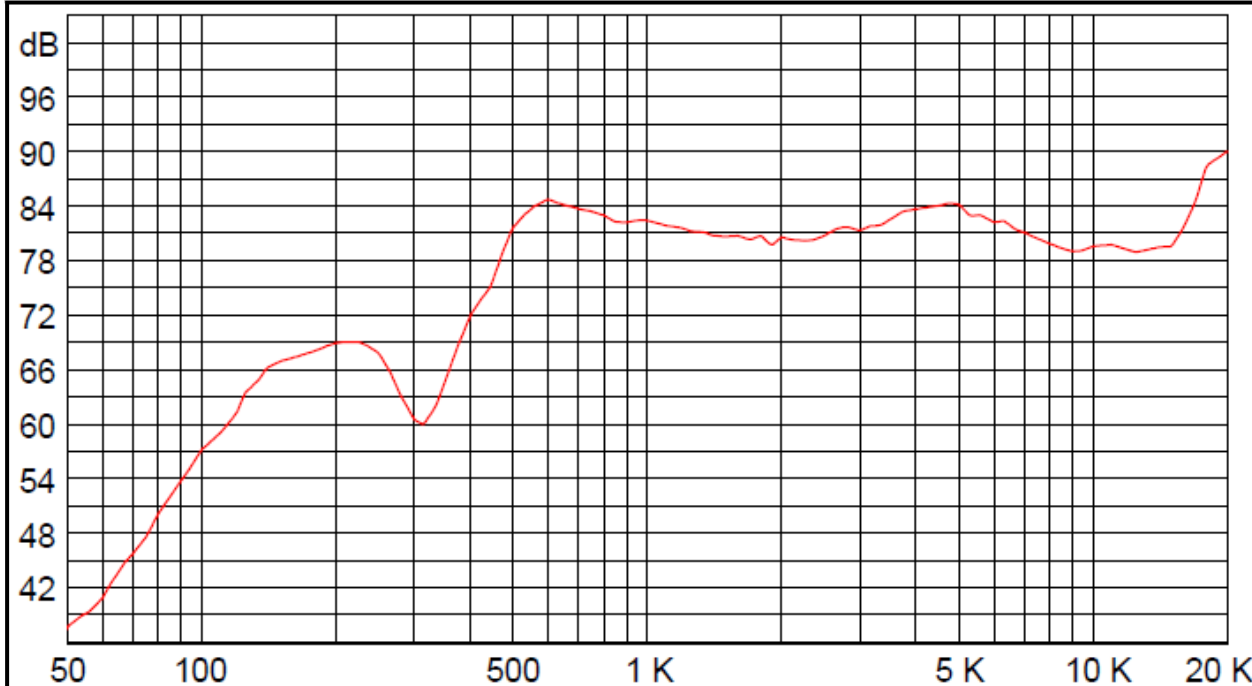

Authorized Distributor





**pui audio**<sup>™</sup>  
a projects unlimited company

## ASE06008MR-LW150-R 60mm Enclosed Speaker

### Mechanical and Environment Testing

Test Description	Test Condition
High Temperature	60°C ±2°C with random humidity for 96 hours
Low Temperature	-25°C ±2°C with random humidity for 96 hours
Humidity	40°C ±2°C with 90% to 95% relative humidity for 48 hours
Vibration	1.5 mm movement modulated at 10 to 55 Hz for 2 hours
Drop Test	75 cm free fall onto concrete floor, 10 cycles
Temperature Cycle Test	-25°C to 60°C, 4 cycles (refer to Temperature Cycle Test Graph)

After tests, speaker shall rest for 1 hours. SPL shall not deviate ±4 dB from pre-test measurement.

### Temperature Cycle Test Graph

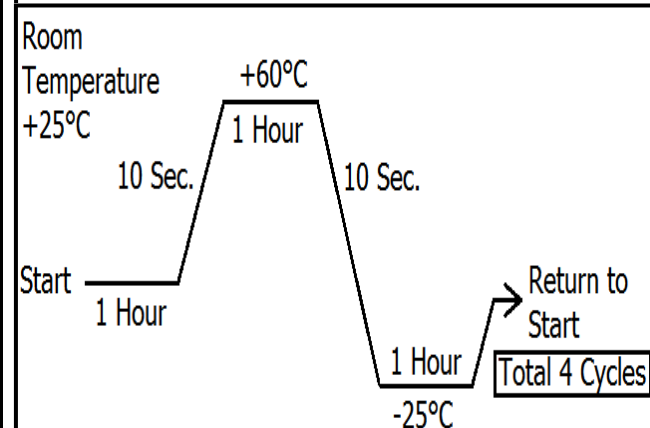

### Frequency Response and SPL Measurement Setup

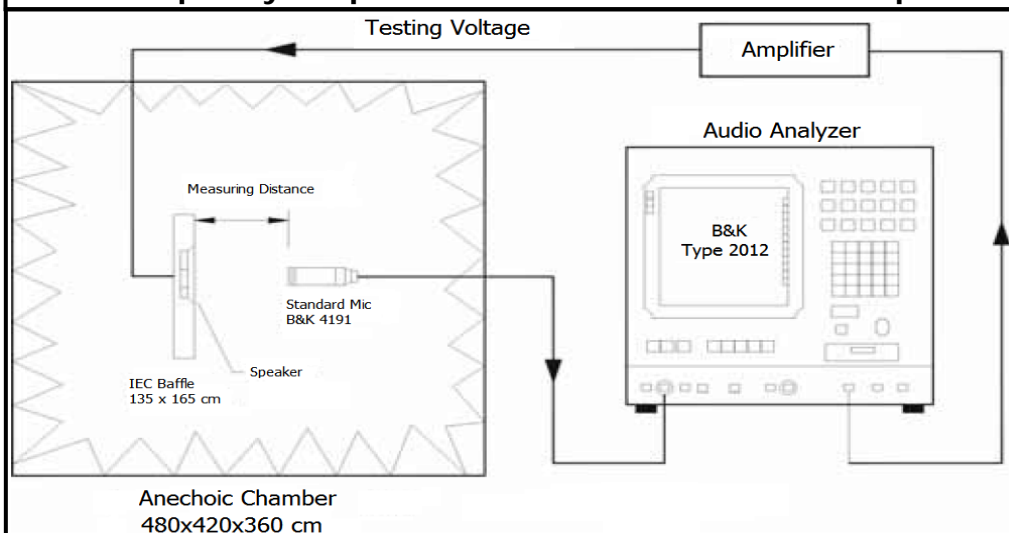

### Speaker Parameters

Specification	ASE06008MR
F <sub>o</sub> (Hz)	550
Frequency Range	550 ~ 20,000
Impedance (ohm)	8
SPL (dB) @ 1W/0.5m	83

# SPECIFICATIONS

PARAMETERS	VALUES	UNITS
RATED INPUT POWER	3	W
MAX INPUT POWER	4	W
IMPEDANCE	8 ± 15%	OHM
OUTPUT SPL @ 1W/0.5M (AT 0.8, 1.0, 1.2, 1.5 kHz)	83± 3	dB
DISTORTION (MAX.)	5%	-
RESONANT FREQUENCY	500 ± 20%	Hz
FREQUENCY RANGE	400 ~ 20,000	Hz
HOUSING MATERIAL	ABS	-
CONE MATERIAL	MYLAR	-
MAGNET MATERIAL	RARE EARTH	-
OPERATING TEMPERATURE	-25 ~ +60	°C
WEIGHT	13.7	grams

THIS DOCUMENT CONTAINS DATA PROPRIETARY TO PROJECTS UNLIMITED, INC. ANY USE OR REPRODUCTION, IN ANY FORM, WITHOUT PRIOR WRITTEN PERMISSION OF PROJECTS UNLIMITED, INC. IS PROHIBITED.  
©2003, Projects Unlimited Inc.

# REVISION HISTORY

LTR	DESCRIPTION	DATE	APPROVED
-	RELEASED FROM ENGINEERING	1/23/2014	

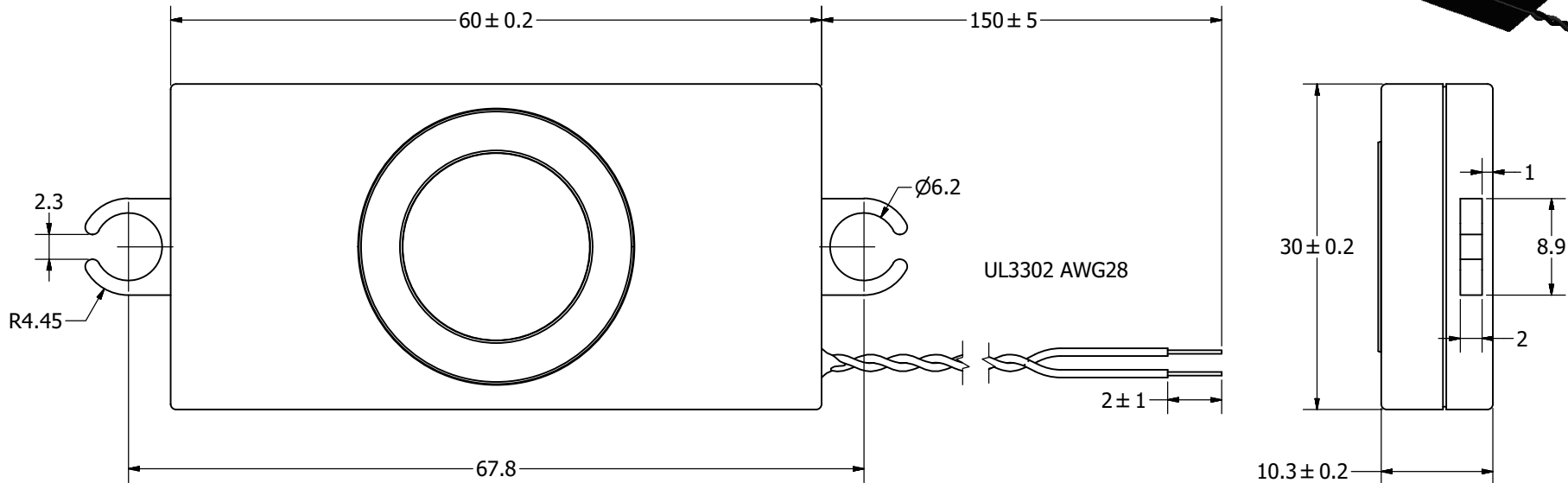
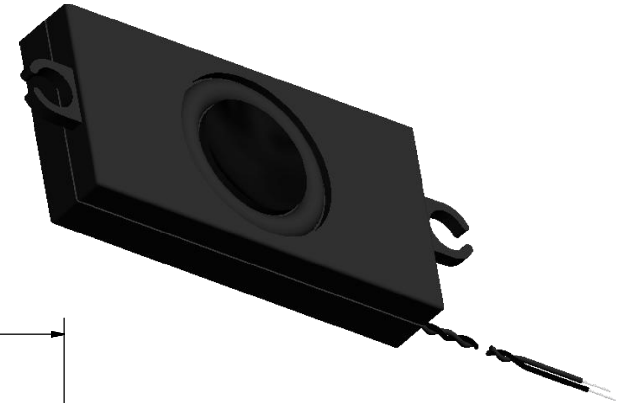

### NOTES:

1. ALL DIMENSIONS ARE IN MILLIMETERS.
2. SPECIFICATIONS SUBJECT TO CHANGE OR WITHDRAWAL WITHOUT NOTICE.
3. THIS PART IS RoHS 2011/65/EU COMPLIANT.

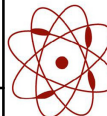
UNLESS OTHERWISE SPECIFIED: DIMENSIONS ARE IN MILLIMETERS, TOLERANCES ARE ±0.5 AND ANGLES ARE ±3°.	SIZE <b>A3</b>	Designed by	Date	Checked by	Date	Approved by	Date	Drawn Date
		J.D.	1/22/2014	M.L.	1/22/2014	B.R.	1/22/2014	1/22/2014
ASE06008MR-LW150-R.idw		 <b>pui audio</b> a projects unlimited company		<b>ASE06008MR-LW150-R</b> Speaker			Edition	Sheet
							-	1 / 1

## X-ON Electronics

Largest Supplier of Electrical and Electronic Components

*Click to view similar products for [Speakers & Transducers](#) category:*

*Click to view products by [PUI Audio](#) manufacturer:*

Other Similar products are found below :

[FC-30814-P127](#) [AS02832MR-2-R](#) [PB-1220PE](#) [PB-2015PQ](#) [900-00001](#) [AB2025B-LW50-R](#) [SWFK-31736-000](#) [PT-2065FW](#) [PT-4175W](#) [AT-2830-TW-LW35-R](#) [ED-30761-000](#) [CI-30120-A42](#) [SMT-0440-T-2-R](#) [PB-0927PQ](#) [BF-7083-000](#) [BF-9778-000](#) [SMS2020-08H4.5 LF](#) [BDT1717-08H6.5W56MLF](#) [02094](#) [02097](#) [GSPK1003PN-8R0.2W-L100](#) [GSPK151103TN-8R0.2W](#) [GSPK2014035PN-8R0.5W-L100](#) [FS5353DS0830-H19.3](#) [TE082703-8](#) [XMLP040BD21F](#) [AS03608MR-LW100-R](#) [24520](#) [SMT-0540-S-2-R](#) [1450069](#) [9091653](#) [9091661](#) [IPS-G6000-5](#) [9090231](#) [FS50MS0820-H9.7](#) [FS4014-4-2W](#) [PBM4-13.B31R.A115.0663](#) [PBM4-13.B33R.A115.0663](#) [PBM4-13.B35R.A115.0663](#) [A-10-6-BG360-HD1Z-GA-M4Z-ZW](#) [A-10-6-BG410-HD1Z-AA-AGZ-ZW](#) [A-10-6-BG410-HD1Z-AA-M4Z-ZW](#) [A-10-6-BG410-HD1Z-FC-AGZ-ZW](#) [A-10-6-BG410-HD1Z-GA-M4Z-ZW](#) [A-10-6-BG310-HD1Z-AA-AGZ-ZW](#) [A-10-6-BG310-HD1Z-AA-M4Z-ZW](#) [A-10-6-BG310-HD1Z-GA-M4Z-ZW](#) [A-10-6-BG316-HD1Z-AA-AGZ-ZW](#) [A-10-6-BG316-HD1Z-AA-M4Z-ZW](#) [A-10-6-BG325-HD1Z-AA-AGZ-ZW](#)