

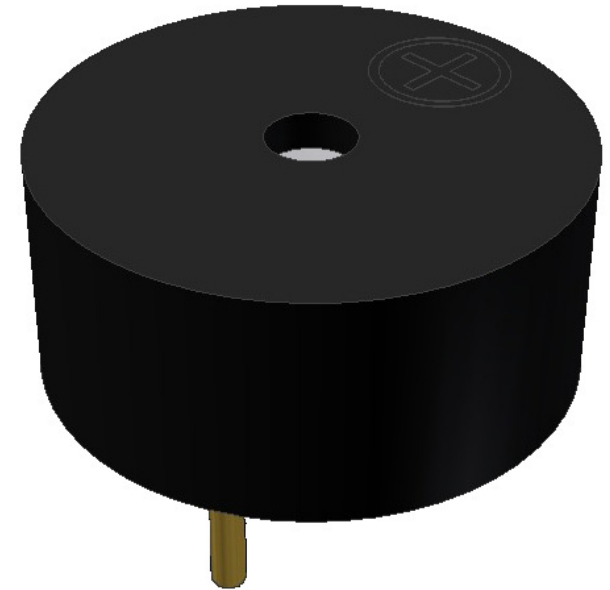

**pui**  
**audio**™ inc  
a projects unlimited company

## AT-0927-TT-2-R 9mm Transducer



3541 Stop Eight Road • Dayton, Ohio 45414

### Product Overview

- Small 9mm diameter electro-mechanical transducer
- 86 dBA minimum output (3 Vp-p @ 10 cm) and 2,730 kHz resonant frequency
- PBT housing withstands Wave soldering temperatures
- Through-hole design for quick PCB placement

Frequency Response (3 Vp-p @ 0.1 meters)

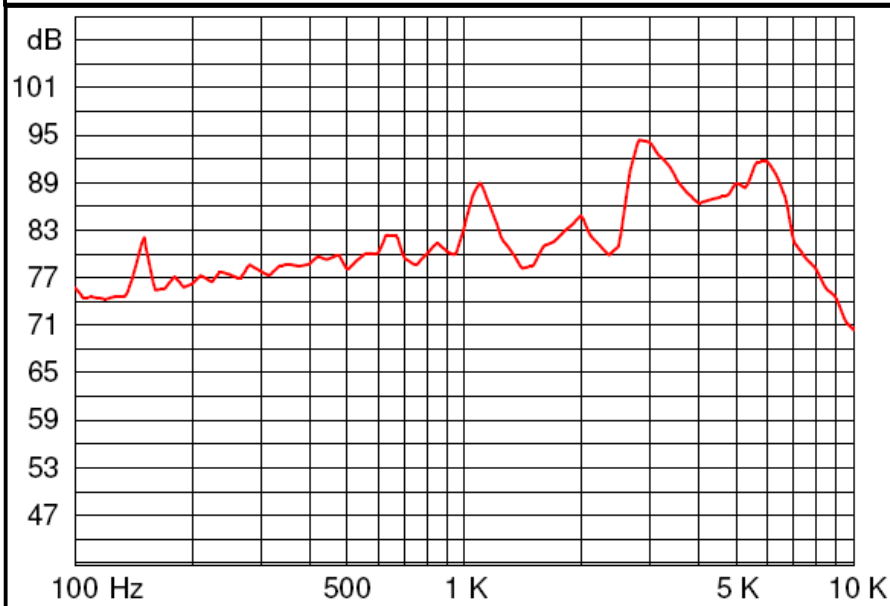

RoHS Compliant





# AT-0927-TT-2-R 9mm Transducer

## Mechanical and Environment Testing

Test Description	Test Condition
High Temperature	80°C (±2°C) with random humidity for 96 hours
Low Temperature	-30°C (±2°C) with random humidity for 96 hours
Humidity	25°C to 80°C with 90% to 95% relative humidity for 24 hours
Vibration	1.5 mm movement modulated at 10-55 Hz, 3 axis, for 2 hours
Drop Test	75 cm free fall onto 40 mm wood board, 3 axis, 3 cycles per axis
Temperature Cycle Test	-30°C to 80°C, 100 cycles

After tests, part shall rest for 4 hours. SPL shall be within ±10 dB of original measurement.

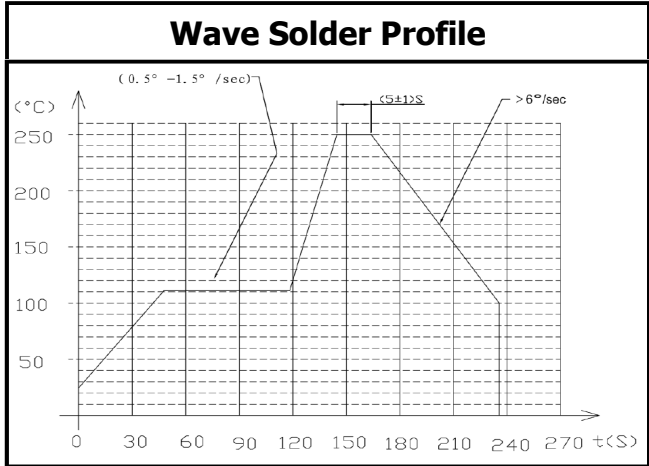

## Frequency Response and SPL Measurement Setup

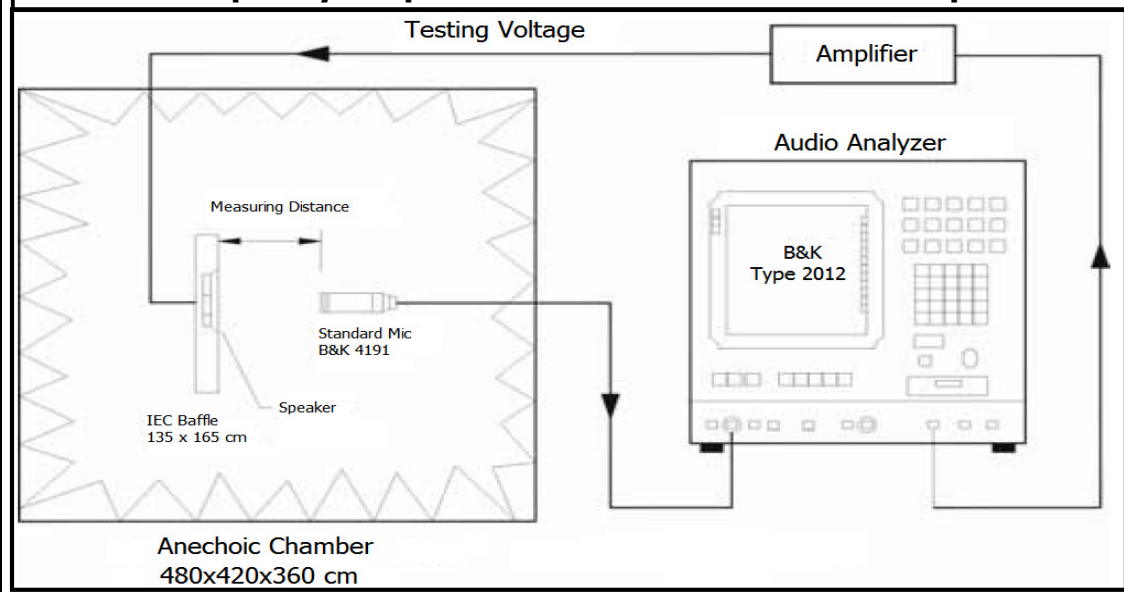

## Temperature Cycle Test Graph

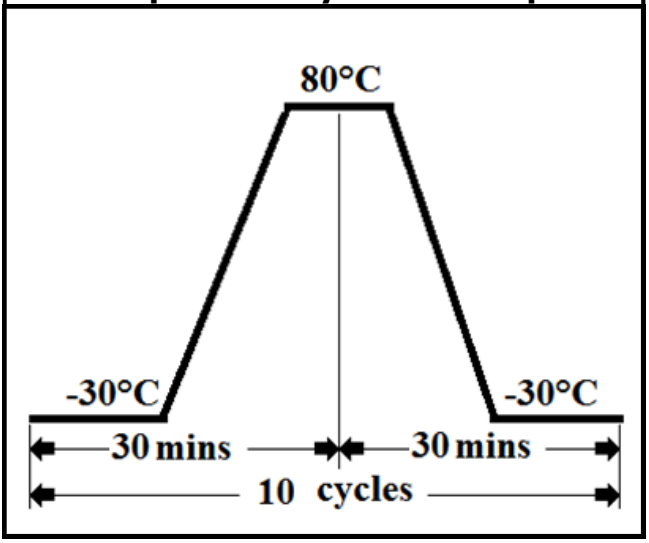

# SPECIFICATIONS

PARAMETERS	VALUES	UNIT
RATED VOLTAGE	3	Vp-p
OPERATING VOLTAGE RANGE	2 ~ 4	Vp-p
RATED CURRENT (MAX)	70	mA
COIL RESISTANCE	20 ± 3	OHM
MINIMUM SPL @ 10 CM	86	dBA
RESONANT FREQUENCY	2,730 ± 500	Hz
OPERATING TEMPERATURE	-20 ~ +70	°C
STORAGE TEMPERATURE	-30 ~ +80	°C
HOUSING MATERIAL	PBT	-
TERMINAL MATERIAL	Au PLATED PHOSPHOR BRONZE	-
WEIGHT	0.7	grams

THIS DOCUMENT CONTAINS DATA PROPRIETARY TO PROJECTS UNLIMITED, INC. ANY USE OR REPRODUCTION, IN ANY FORM, WITHOUT PRIOR WRITTEN PERMISSION OF PROJECTS UNLIMITED, INC. IS PROHIBITED.  
©2003, Projects Unlimited Inc.

# REVISION HISTORY

LTR	DESCRIPTION	DATE	APPROVED
-	RELEASED FROM ENGINEERING	8/5/2005	
A	REVISED TO INVENTOR 3-D DRAWING TEMPLATE	4/1/2008	B.R.

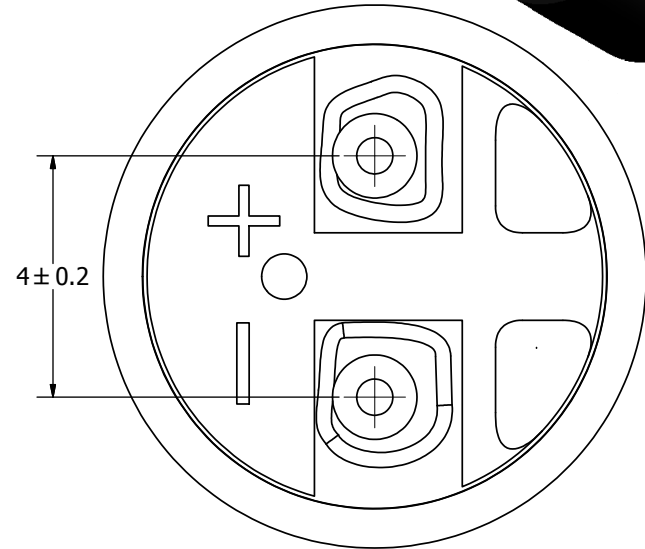
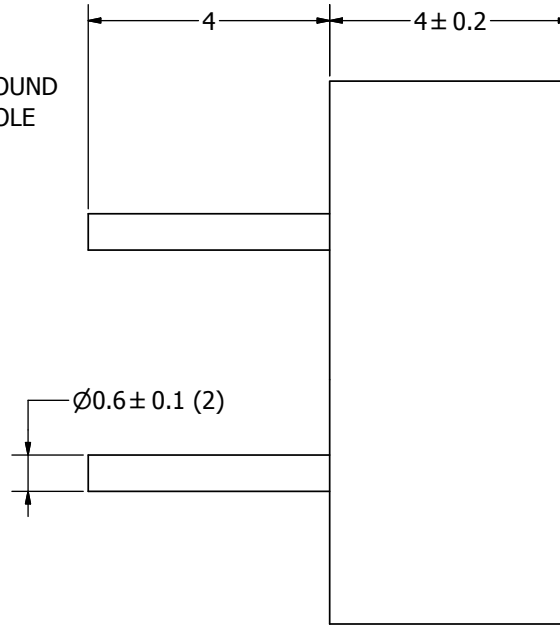
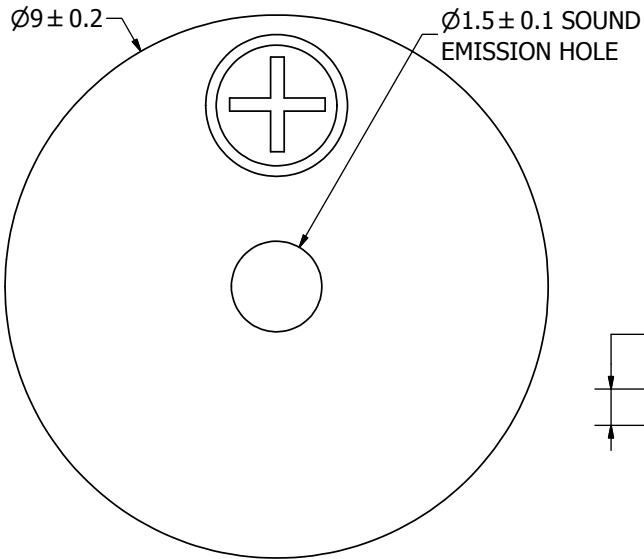
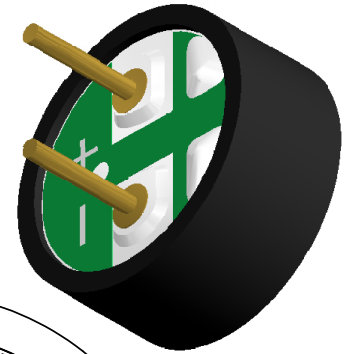

## NOTES:

- ALL DIMENSIONS ARE IN MILLIMETERS.
- SPECIFICATIONS SUBJECT TO CHANGE OR WITHDRAWL WITHOUT NOTICE.
- THIS PART IS RoHS 2002/95/EC COMPLIANT.

UNLESS OTHERWISE SPECIFIED: DIMENSIONS ARE IN MILLIMETERS, TOLERANCES ARE ±0.5 AND ANGLES ARE ±3°.	SIZE <b>A3</b>	Designed by	Date	Checked by	Date	Approved by	Date	Drawn Date
		J.A.F.	8/5/2005	E.P.	8/5/2005	B.R.	8/5/2005	4/1/2008
AT-0927-TT-2-R.idw		 <b>AT-0927-TT-2-R</b> Transducer (Electro-Mech)				Edition	Sheet	
						-	1 / 1	

## X-ON Electronics

Largest Supplier of Electrical and Electronic Components

*Click to view similar products for [Speakers & Transducers](#) category:*

*Click to view products by [PUI Audio](#) manufacturer:*

Other Similar products are found below :

[FC-30814-P127](#) [AS02832MR-2-R](#) [PB-1220PE](#) [PB-2015PQ](#) [900-00001](#) [AB2025B-LW50-R](#) [SWFK-31736-000](#) [PT-2065FW](#) [PT-4175W](#) [AT-2830-TW-LW35-R](#) [ED-30761-000](#) [CI-30120-A42](#) [SMT-0440-T-2-R](#) [PB-0927PQ](#) [BF-7083-000](#) [BF-9778-000](#) [SMS2020-08H4.5 LF](#) [BDT1717-08H6.5W56MLF](#) [02094](#) [02097](#) [GSPK1003PN-8R0.2W-L100](#) [GSPK151103TN-8R0.2W](#) [GSPK2014035PN-8R0.5W-L100](#) [FS5353DS0830-H19.3](#) [TE082703-8](#) [XMLP040BD21F](#) [AS03608MR-LW100-R](#) [24520](#) [SMT-0540-S-2-R](#) [1450069](#) [9091653](#) [9091661](#) [IPS-G6000-5](#) [9090231](#) [FS50MS0820-H9.7](#) [FS4014-4-2W](#) [PBM4-13.B31R.A115.0663](#) [PBM4-13.B33R.A115.0663](#) [PBM4-13.B35R.A115.0663](#) [A-10-6-BG360-HD1Z-GA-M4Z-ZW](#) [A-10-6-BG410-HD1Z-AA-AGZ-ZW](#) [A-10-6-BG410-HD1Z-AA-M4Z-ZW](#) [A-10-6-BG410-HD1Z-FC-AGZ-ZW](#) [A-10-6-BG410-HD1Z-GA-M4Z-ZW](#) [A-10-6-BG310-HD1Z-AA-AGZ-ZW](#) [A-10-6-BG310-HD1Z-AA-M4Z-ZW](#) [A-10-6-BG310-HD1Z-GA-M4Z-ZW](#) [A-10-6-BG316-HD1Z-AA-AGZ-ZW](#) [A-10-6-BG316-HD1Z-AA-M4Z-ZW](#) [A-10-6-BG325-HD1Z-AA-AGZ-ZW](#)