

PNM-3546L-R Noise-Canceling Microphone

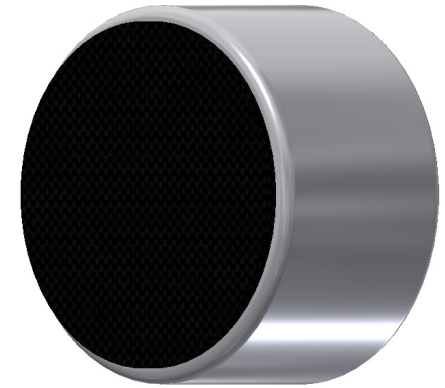

3541 Stop Eight Road • Dayton, Ohio 45414

Product Overview

- 6mm overall diameter and 3.5mm height with solder pads
- -46 dB sensitivity for use in most environments
- Wide 2 to 10 VDC operating voltage and 50-16,000 Hz frequency response
- >68 dB signal-to-noise ratio and 2.2 kOhm impedance
- Omni-directional polar pattern for great off-axis response

Typical Frequency Response and Sensitivity

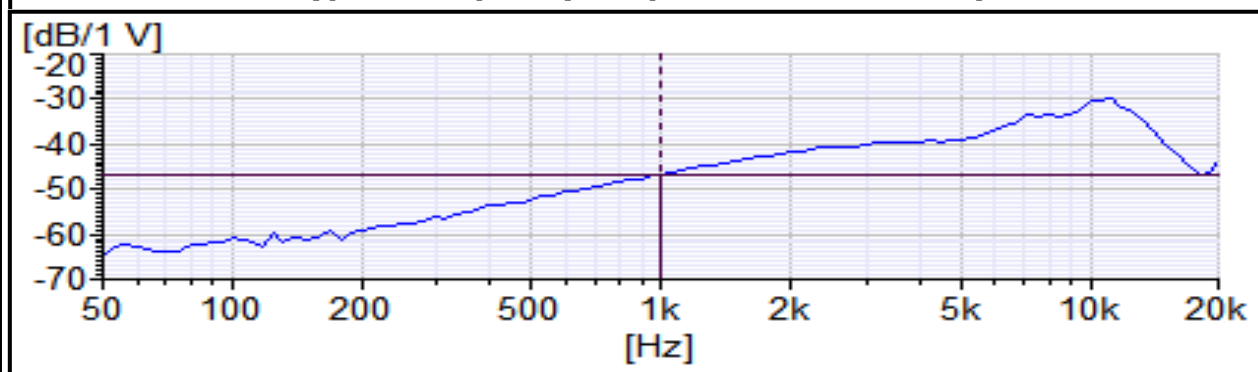

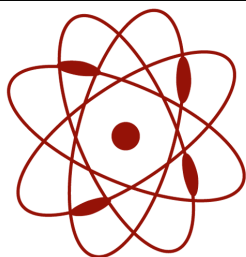

pui
audio™ inc
a projects unlimited company

PNM-3546L-R Noise-Canceling Microphone

Mechanical and Environment Testing	
Test Description	Test Condition
High Temperature	70°C with random humidity for 200 hours
Low Temperature	-25°C with random humidity for 200 hours
Humidity	40°C with 90% relative humidity for 200 hours
Vibration	3 mm movement for 3 minutes in each of 3 axis
Drop Test	70 cm free fall onto 20 mm thick board, two directions
Temperature Cycle Test	-10°C to 50°C, 5 cycles

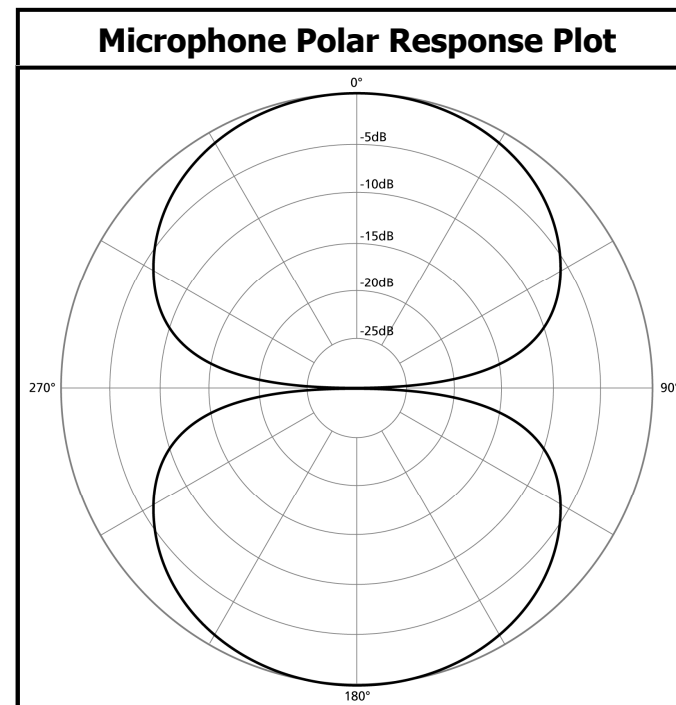
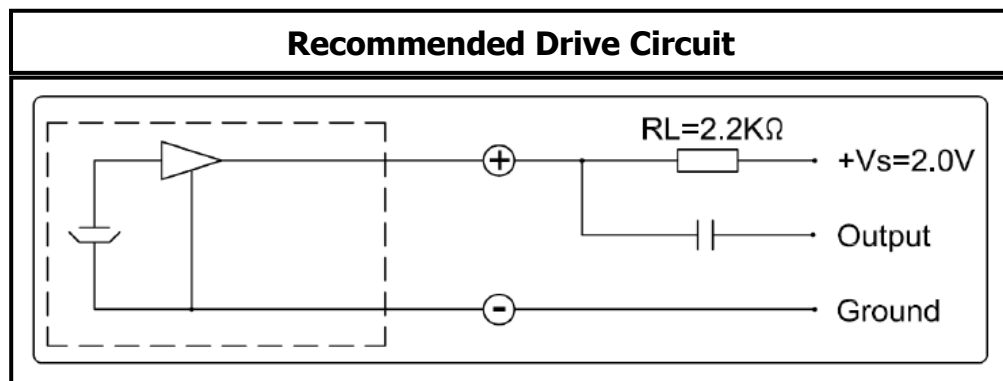

SPECIFICATIONS

PARAMETERS	VALUES	UNIT
DIRECTIVITY	NOISE CANCELLING	-
SENSITIVITY	-46 ± 4	dB
STANDARD OPERATING VOLTAGE	2	Vdc
MAX OPERATING VOLTAGE	10	Vdc
CURRENT CONSUMPTION (MAX)	0.5	mA
IMPEDANCE	2.2	KOhm
SIGNAL TO NOISE RATIO (MIN.)	60	dB
MAXIMUM SOUND INPUT	110	dB
OPERATING TEMPERATURE	-20 ~ +70	°C
STORAGE TEMPERATURE	-40 ~ +85	°C
TERMINAL	SOLDER PADS	-
INTERNAL CAPACITOR	N/A	pF

THIS DOCUMENT CONTAINS DATA PROPRIETARY TO PROJECTS UNLIMITED, INC. ANY USE OR REPRODUCTION, IN ANY FORM, WITHOUT PRIOR WRITTEN PERMISSION OF PROJECTS UNLIMITED, INC. IS PROHIBITED.
©2003, Projects Unlimited Inc.

REVISION HISTORY

LTR	DESCRIPTION	DATE	APPROVED
-	RELEASED FROM ENGINEERING	1/30/2006	
A	ADDED TERMINAL POLARITY	2/1/2007	D.F.
B	REVISED ELECTRICAL PARAMETERS	2/4/2010	B.R.
C	REVISED TO INVENTOR 3-D DRAWING TEMPLATE	9/23/2010	B.R.



Ø6 ± 0.1

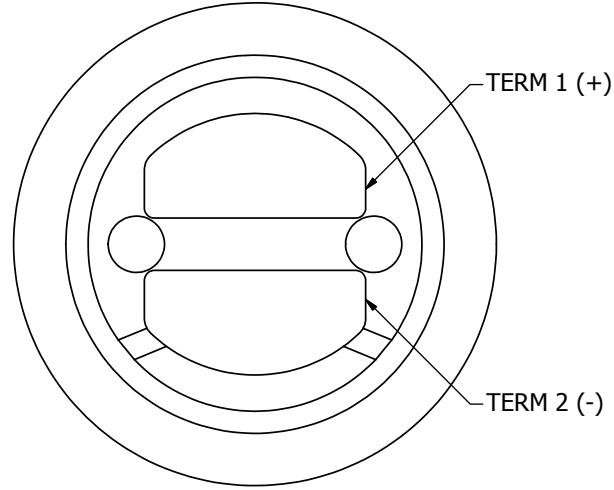
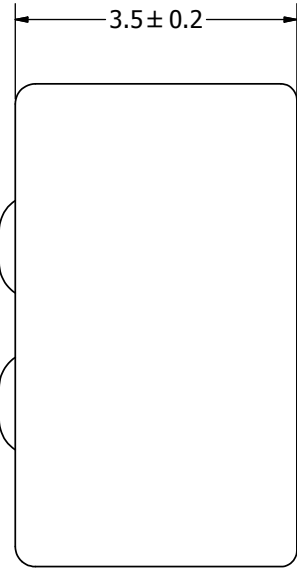
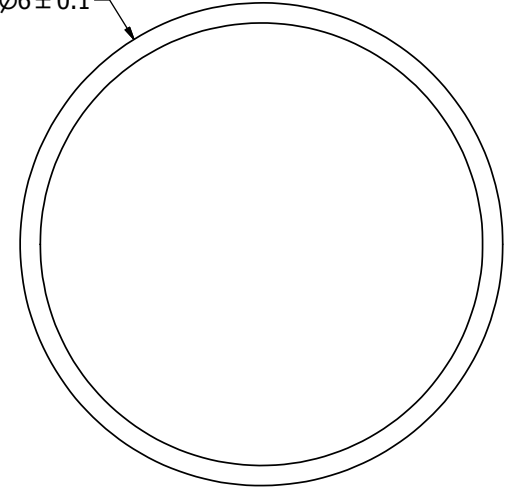

NOTES:

1. ALL DIMENSIONS ARE IN MILLIMETERS.
2. SPECIFICATIONS SUBJECT TO CHANGE OR WITHDRAWAL WITHOUT NOTICE.
3. THIS PART IS RoHS 2002/95/EC COMPLIANT.

UNLESS OTHERWISE SPECIFIED: DIMENSIONS ARE IN MILLIMETERS, TOLERANCES ARE ±0.5 AND ANGLES ARE ±3°.	SIZE A3	Designed by	Date	Checked by	Date	Approved by	Date	Drawn Date	
		J.A.F.	1/30/2006	E.P.	1/30/2006	B.R.	1/30/2006	9/23/2010	
PNM-3546L-R.idw						PNM-3546L-R Microphone		Edition -	Sheet 1 / 1

X-ON Electronics

Largest Supplier of Electrical and Electronic Components

Click to view similar products for [Microphones](#) category:

Click to view products by [PUI Audio](#) manufacturer:

Other Similar products are found below :

[BCM4013OLFC-42-JST-ZHR-2](#) [TO38-30702-B20](#) [SPM04C-38/1186-T/R](#) [BCM4013OSBC-42 LF](#) [TOW-1242P-R](#) [BCM9745-44](#) [BCM9765](#)
[BCM9767P](#) [LD-MC-0905P](#) [LD-MC-6035](#) [PMOF-9745S-42UQ](#) [ROM-2235L-HD-R](#) [CMC-4015-130T](#) [CMC-6050-40T](#) [CMC-6035-130T](#)
[CMC-6015-47P](#) [BCM9745P-44](#) [BCM9767-42](#) [254-ECM644-RO](#) [LD-MC-4011](#) [LD-MC-6027](#) [LD-MC-6035W](#) [LD-MC-9765P](#) [LD-MC-](#)
[9765W](#) [FG-23629-D65](#) [PNR-23539-000](#) [254-FP270-RO](#) [BCM9765P-44](#) [CMC-5042PF-AC](#) [CMC-6010-42L100](#) [CMC-9745-L100](#) [CMC-](#)
[3015-44T](#) [CMC-4015-25T](#) [CMC-6013-38T](#) [CMC-6022-37L100](#) [CMC-6027-24T](#) [CMC-6027-32T](#) [CMC-6027-42T](#) [GMI4522P-2C-30db](#)
[GMI4522P-2C-50db](#) [GMI4522P-2C-52db](#) [GMI6027P-2C66DB](#) [GMA3526H10-B26](#) [GMA4030H11-F26](#) [GMI4015-32DB](#) [GMI4015-40DB](#)
[GMI4015P-36DB](#) [GMI4015P-46DB](#) [GMI4015P-54DB](#) [GMI4015P-58DB](#)