



pui
audio™ inc
a projects unlimited company

SMT-0825-T-R 8.5x8.5mm Transducer

3541 Stop Eight Road • Dayton, Ohio 45414

Product Overview

- Top-firing electromechanical transducer designed for 2.5 to 4.5 V
- Small 8.5 x 8.5mm footprint and 4mm height for thin, modern devices
- 87 dBA minimum output (3.6V @ 10 cm) and 2.5kHz resonant frequency
- Designed for reflow soldering using a lead-free profile

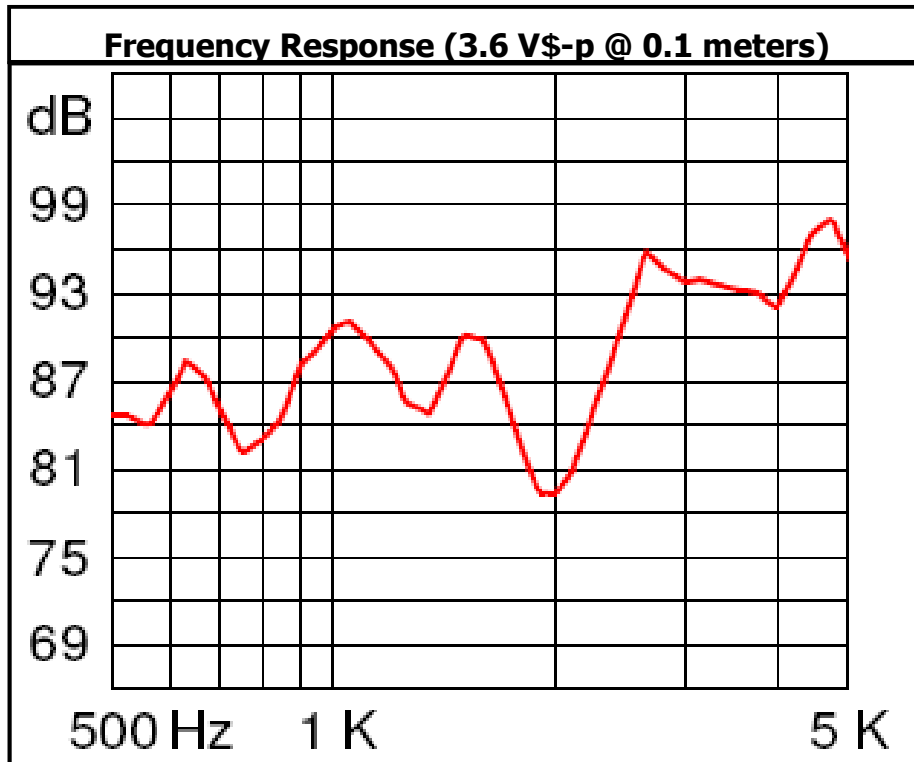
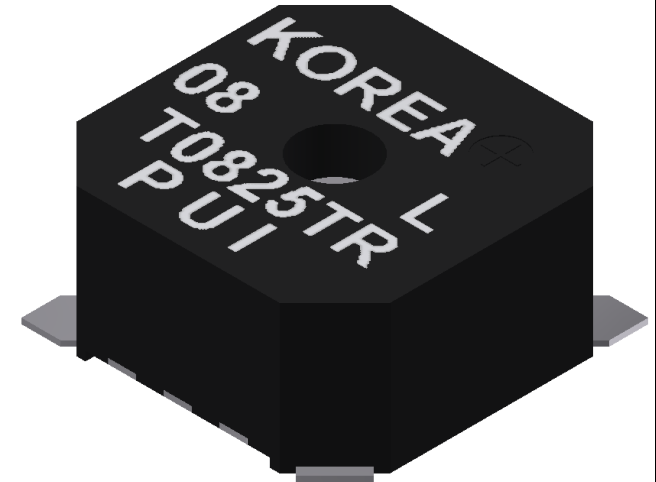

RoHS Compliant





SMT-0825-T-R

8.5x8.5mm

Transducer

Mechanical and Environment Testing

| Test Description | Test Condition |
|------------------------|--|
| High Temperature | 85°C (±2°C) with random humidity for 96 hours |
| Low Temperature | -40°C (±2°C) with random humidity for 96 hours |
| Humidity | 25°C to 60°C with 90% to 95% relative humidity for 12 hours, 10 cycles |
| Vibration | 1.53 mm movement modulated at 10-55 Hz in 3 directions for 6 hours |
| Drop Test | 120 cm free fall in six directions, 3 cycles |
| Temperature Cycle Test | -30°C to 70°C, five 90 minute cycles |

Recommended Reflow Profile

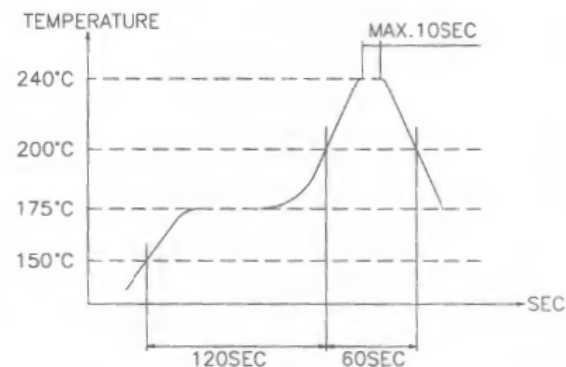

Tape Dimensions

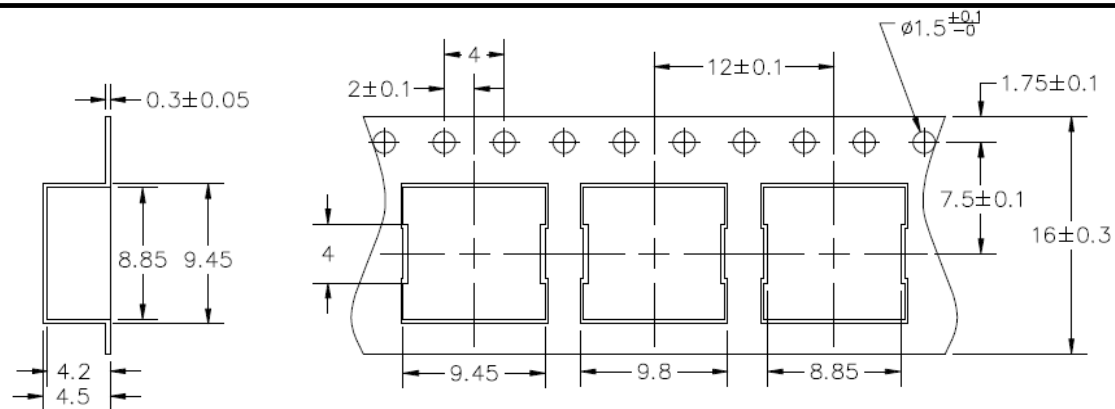

SMT-0825-T-R
Tape Dimensions
2,000 PCS/Reel

Recommended Land Pattern

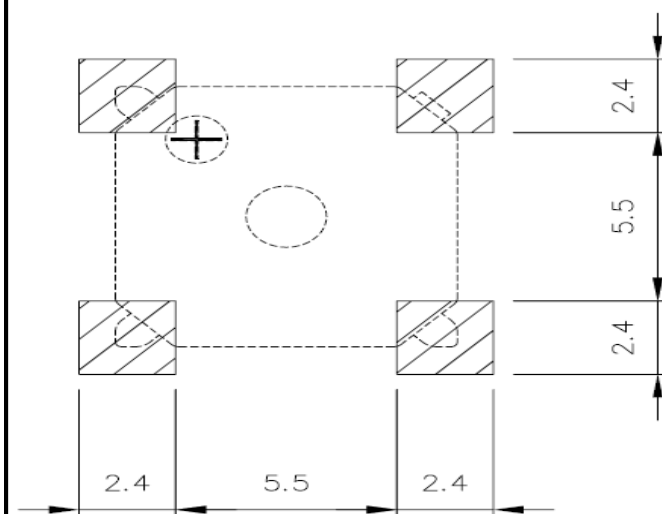

| | | |
|-------------------|---------------|-------|
| TERMINAL MATERIAL | Sn PLATED PBS | - |
| WEIGHT | 0.42 | grams |

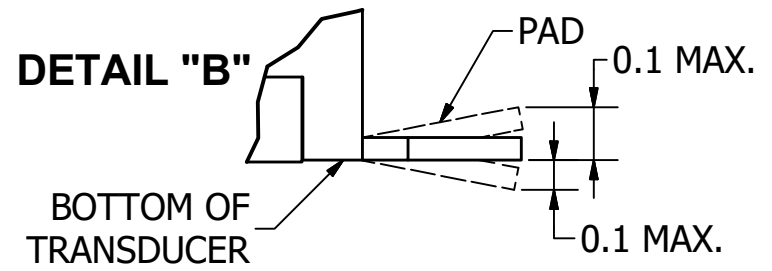
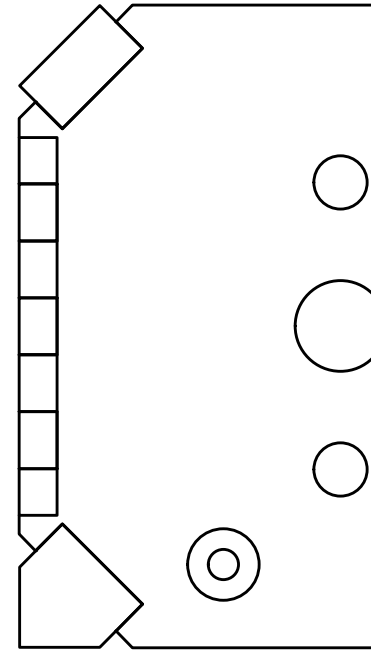
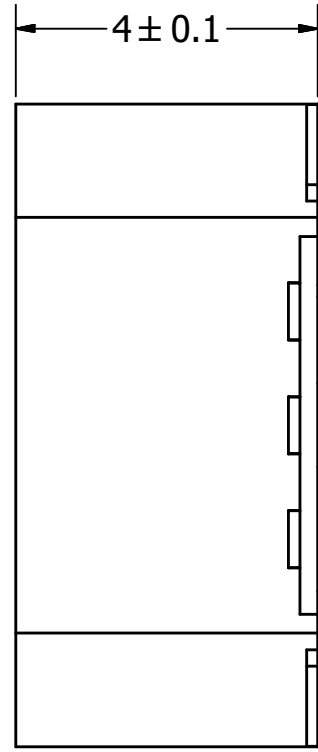
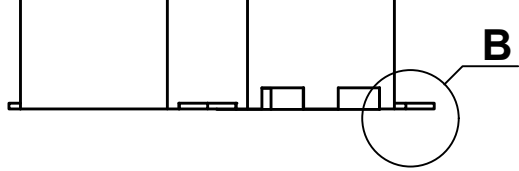
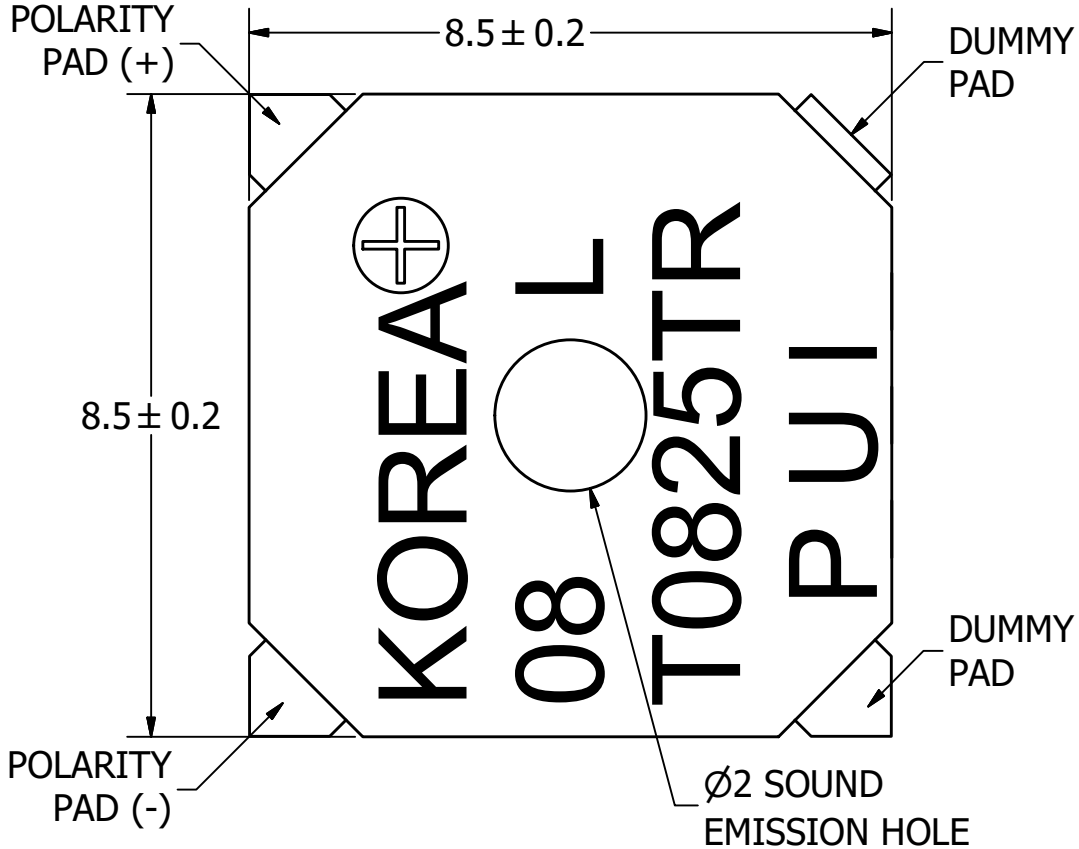

NOTES:

1. ALL DIMENSIONS ARE IN MILLIMETERS.
2. SPECIFICATIONS SUBJECT TO CHANGE OR WITHDRAWAL WITHOUT NOTICE.
3. THIS PART IS RoHS 2002/95/EC COMPLIANT.

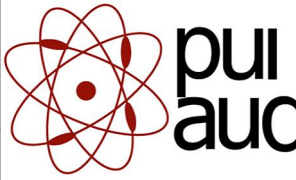
| | | | |
|--|-----------|---|--------|
| UNLESS OTHERWISE SPECIFIED: DIMENSIONS ARE IN MILLIMETERS, TOLERANCES ARE ± 0.5 AND ANGLES ARE $\pm 3^\circ$. | SIZE | Designed by | Date |
| | A3 | R.A.C. | 1/4/20 |
| SMT-0825-T-R.idw | |  | |

X-ON Electronics

Largest Supplier of Electrical and Electronic Components

Click to view similar products for [Speakers & Transducers](#) category:

Click to view products by [PUI Audio](#) manufacturer:

Other Similar products are found below :

[FC-30814-P127](#) [AS02832MR-2-R](#) [PB-1220PE](#) [PB-2015PQ](#) [900-00001](#) [AB2025B-LW50-R](#) [SWFK-31736-000](#) [PT-2065FW](#) [PT-4175W](#) [AT-2830-TW-LW35-R](#) [ED-30761-000](#) [CI-30120-A42](#) [SMT-0440-T-2-R](#) [PB-0927PQ](#) [BF-7083-000](#) [BF-9778-000](#) [SMS2020-08H4.5 LF](#) [BDT1717-08H6.5W56MLF](#) [02094](#) [02097](#) [GSPK1003PN-8R0.2W-L100](#) [GSPK151103TN-8R0.2W](#) [GSPK2014035PN-8R0.5W-L100](#) [FS5353DS0830-H19.3](#) [TE082703-8](#) [XMLP040BD21F](#) [AS03608MR-LW100-R](#) [24520](#) [SMT-0540-S-2-R](#) [1450069](#) [9091653](#) [9091661](#) [IPS-G6000-5](#) [9090231](#) [FS50MS0820-H9.7](#) [FS4014-4-2W](#) [PBM4-13.B31R.A115.0663](#) [PBM4-13.B33R.A115.0663](#) [PBM4-13.B35R.A115.0663](#) [A-10-6-BG360-HD1Z-GA-M4Z-ZW](#) [A-10-6-BG410-HD1Z-AA-AGZ-ZW](#) [A-10-6-BG410-HD1Z-AA-M4Z-ZW](#) [A-10-6-BG410-HD1Z-FC-AGZ-ZW](#) [A-10-6-BG410-HD1Z-GA-M4Z-ZW](#) [A-10-6-BG310-HD1Z-AA-AGZ-ZW](#) [A-10-6-BG310-HD1Z-AA-M4Z-ZW](#) [A-10-6-BG310-HD1Z-GA-M4Z-ZW](#) [A-10-6-BG316-HD1Z-AA-AGZ-ZW](#) [A-10-6-BG316-HD1Z-AA-M4Z-ZW](#) [A-10-6-BG325-HD1Z-AA-AGZ-ZW](#)