

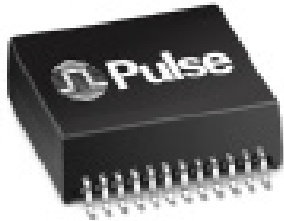



10/100/1000BASE-T SINGLE & DUAL-PORT TRANSFORMER MODULES

Ruggedized



-  Compliant with IEEE 802.ab for 1000Base-T
-  350µH OCL with 8mA bias at extended temperatures
-  Two Operating and Storage Temperature Versions Available:
 - Standard: -40°C to +85°C
 - Extended: -55°C to +125°C
-  245°C peak reflow temperature for RoHS versions (MSL 4)
Lead finish: Sn63/Pb37 (RoHS compliant version available with 100% pure tin)

Electrical Specifications @ 25°C — Operating Temperature -40°C to +85°C

Part Number ^{1,2}	Insertion Loss (dB Min)	Return Loss (dB Max)				Crosstalk (dB Max)			CM to CM Rejection Ratio (dB Max)			DM to CM Rejection Ratio (dB Max)			Hipot (Vrms)
		0.1-100 Mhz	30 Mhz	60 Mhz	80 Mhz	100 Mhz	30 Mhz	60 Mhz	100 Mhz	30 Mhz	60 Mhz	100 Mhz	30 Mhz	60 Mhz	
1000B-5009F	-1.2	-18	-12	-12	-10	-43	-37	-31	-30	-25	-18	-40	-35	-30	1500
1000B-5012F	-1	-18	-12	-12	-10	-43	-37	-33	-43	-37	-33	-43	-37	-33	1500
1000B-5014F	-1.4	-16	-12	-12	-10	-43	-37	-33	-45	-40	-35	-43	-37	-33	1500
1000B-5016F*	-1.2	-18	-12	-12	-10	-43	-37	-31	-30	-23	-17	-40	-35	-30	1500

Note: 1. Add suffix X for extended temperature version; i.e. 1000B-5009F becomes 1000B-5009FX. (*1000B-5016F does not offer X-Version)
2. Add suffix NL for RoHS compliant part; i.e. 1000B-5012F becomes 1000B-5012FNL.

3. For Tape & Reel Packaging, add "T" suffix at the end of the part number; i.e. 1000B-5014FT

Mechanicals

1000B-5009F/X

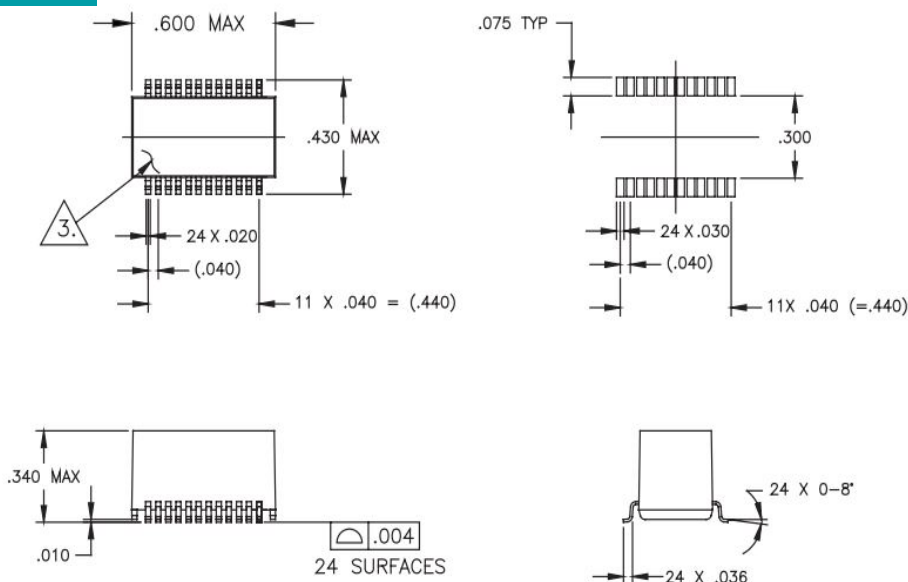

Weight 0.75 grams
Tape and Reel 250/reel
Tube 15/tube

Dimensions: Inches
mm
Unless otherwise specified,
all tolerances are $\pm \begin{matrix} .010 \\ 0.25 \end{matrix}$

10/100/1000BASE-T SINGLE & DUAL-PORT TRANSFORMER MODULES

Ruggedized

1000B-5012/X

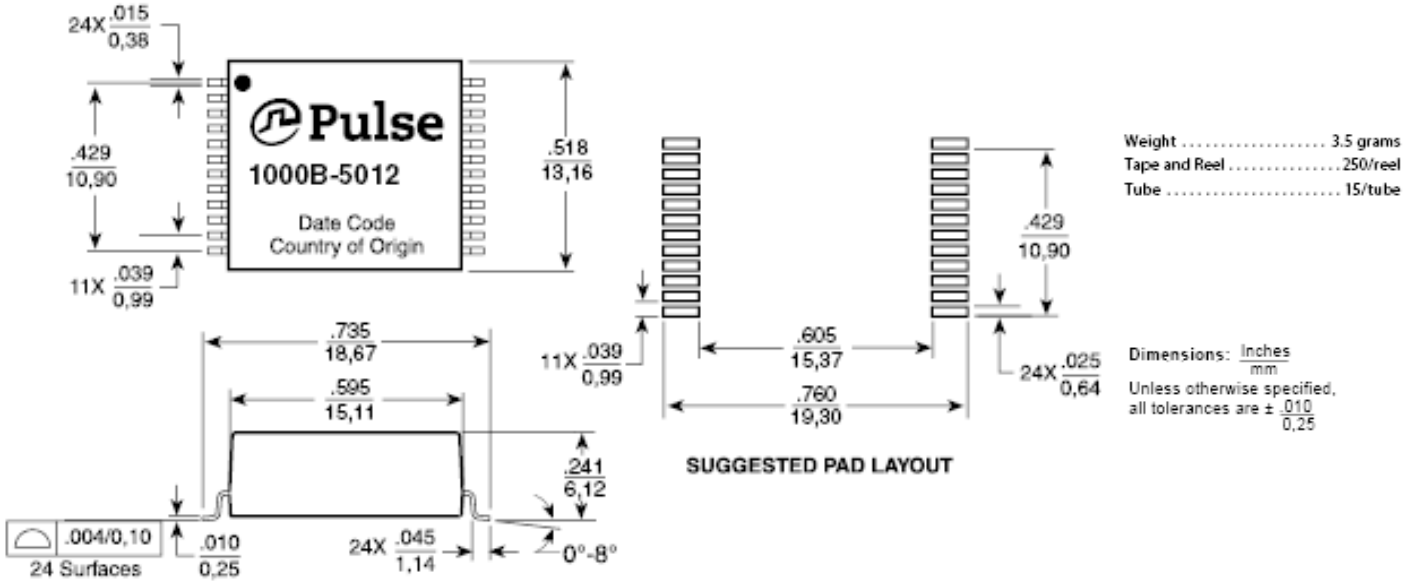

1000B-5014F/X

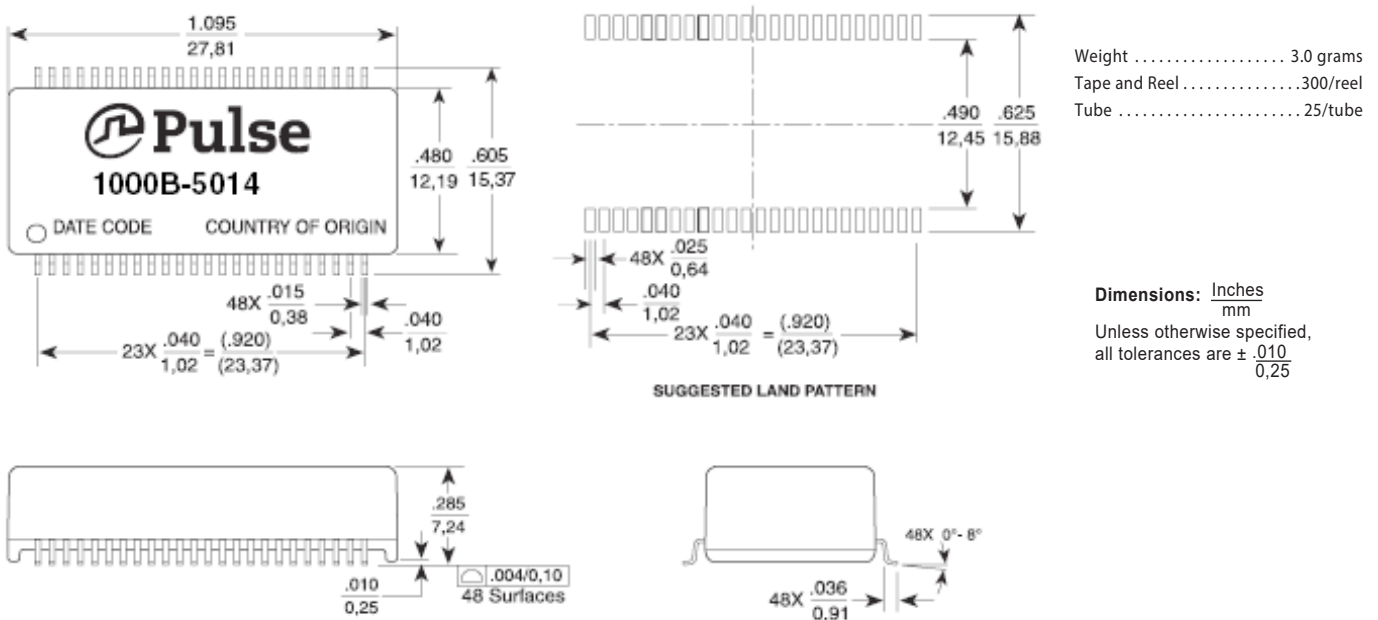

10/100/1000BASE-T SINGLE & DUAL-PORT TRANSFORMER MODULES

Ruggedized

1000B-5016F

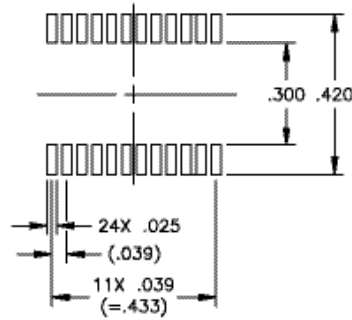
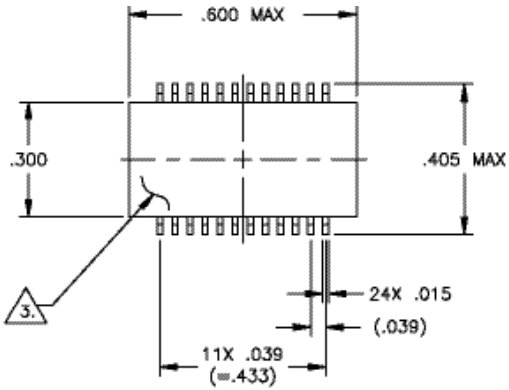

SUGGESTED LAND PATTERN

Weight 0.75 grams
Tape and Reel700/reel
Tube 30/tube

Dimensions: Inches
 mm
Unless otherwise specified,
all tolerances are ± .010
 0,25

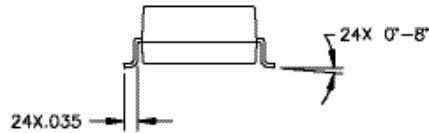
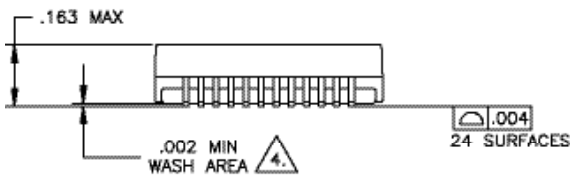

10/100/1000BASE-T SINGLE & DUAL-PORT TRANSFORMER MODULES

Ruggedized

Electrical Schematics

1000B-5009F/X

CHANNEL 1

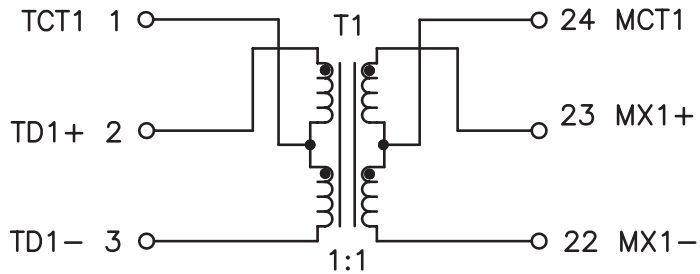

CHANNEL 2

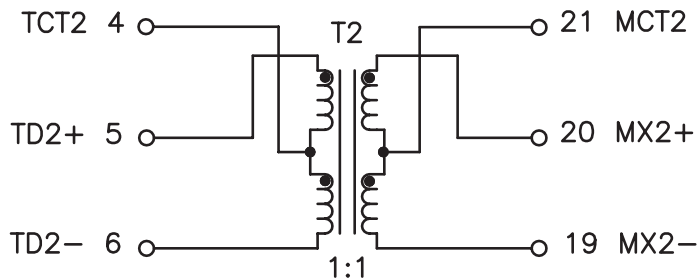

CHANNEL 3

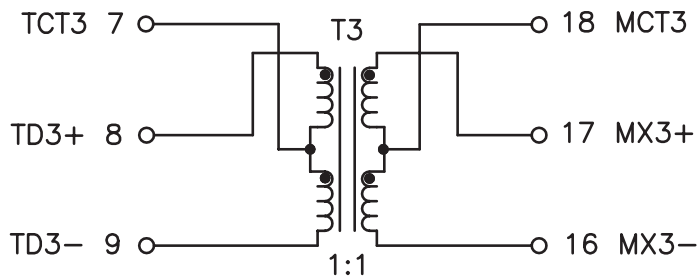

CHANNEL 4

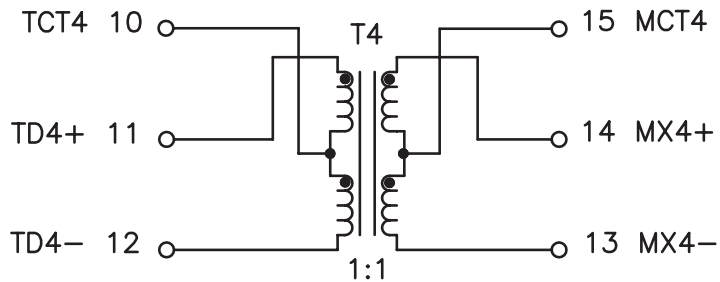

LEGEND

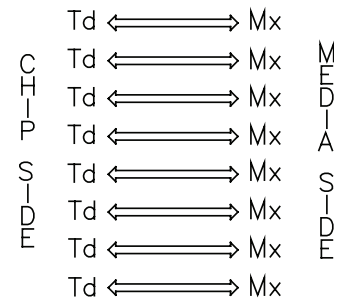

ALL CHANNELS ARE IN PHASE BETWEEN INPUT AND OUTPUT

10/100/1000BASE-T SINGLE & DUAL-PORT TRANSFORMER MODULES

Ruggedized

1000B-5012F/X

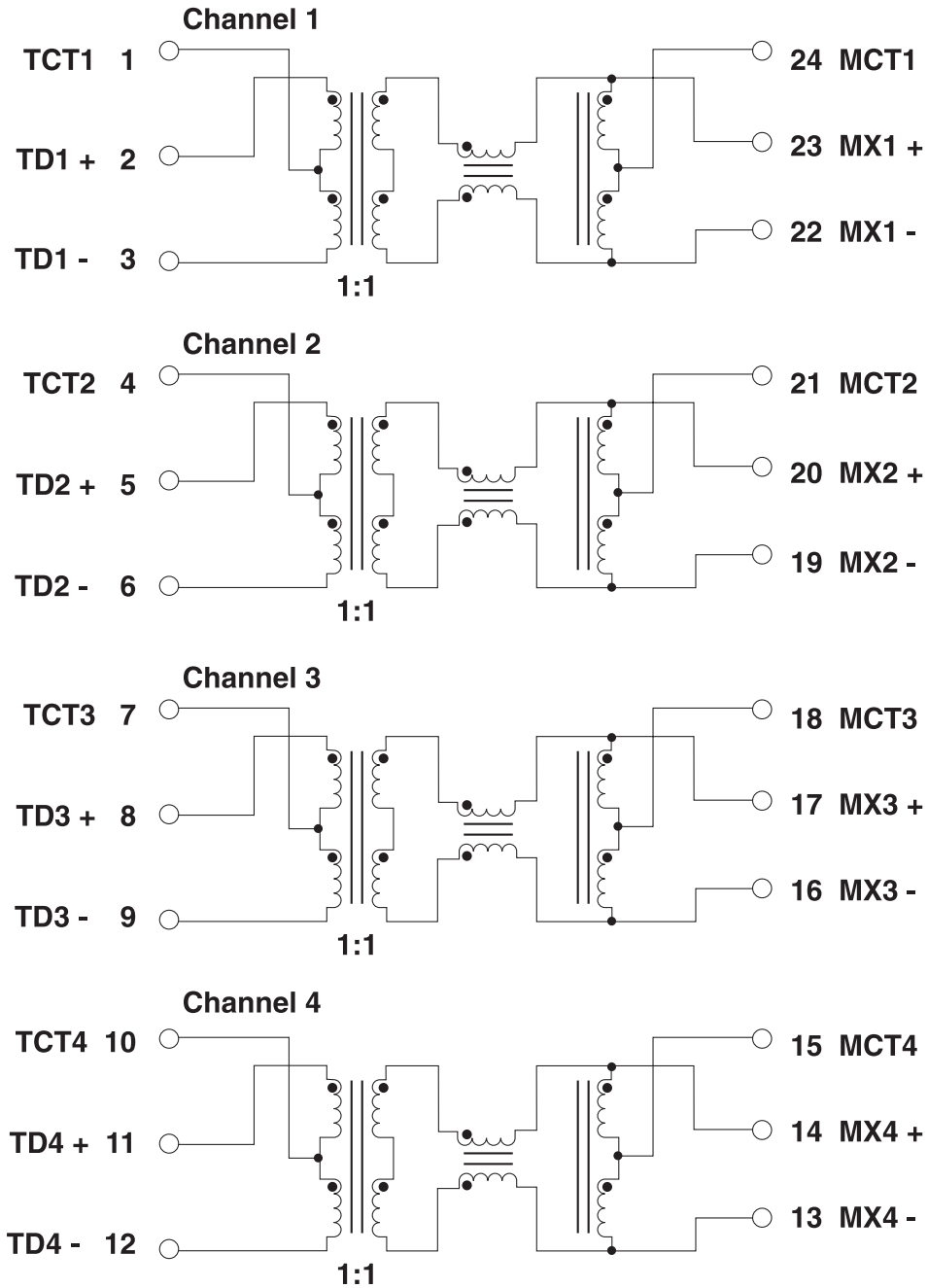

LEGEND

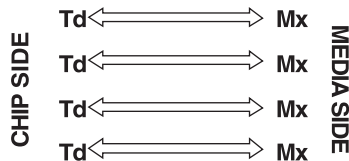

10/100/1000BASE-T SINGLE & DUAL-PORT TRANSFORMER MODULES

Ruggedized

1000B-5014F/X

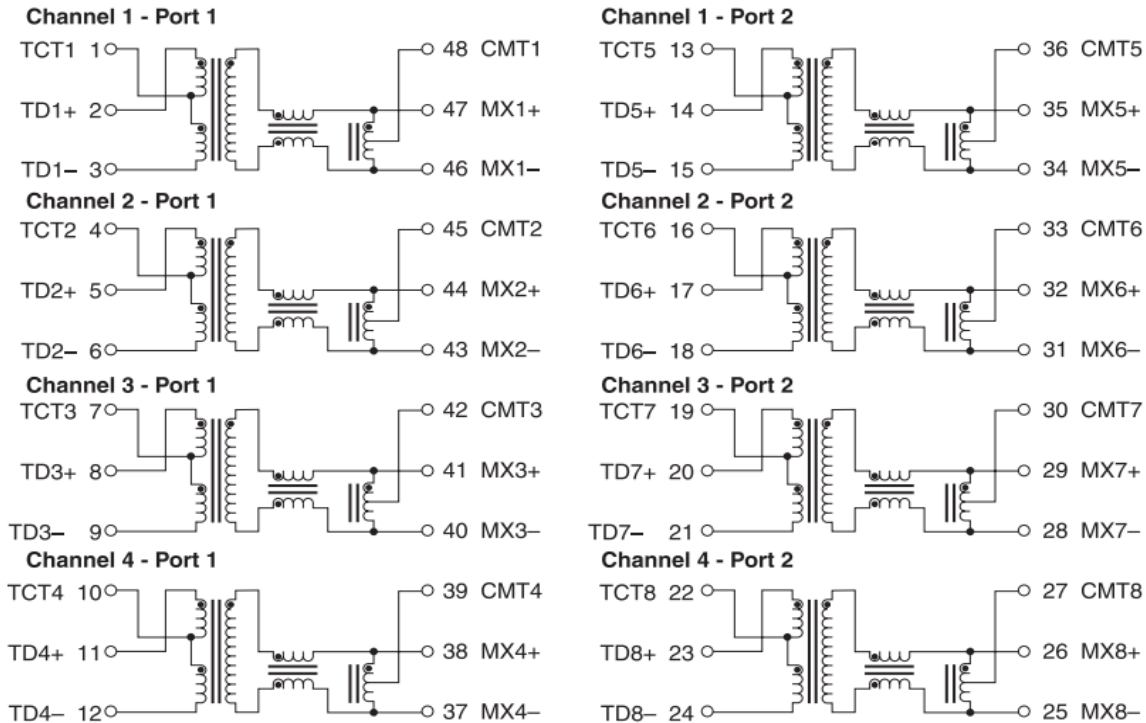

LEGEND

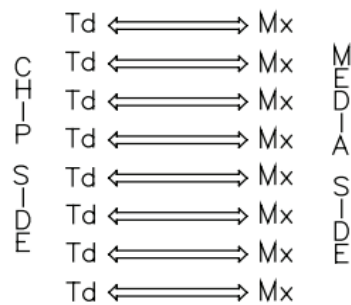

ALL CHANNELS ARE IN PHASE BETWEEN INPUT AND OUTPUT

10/100/1000BASE-T SINGLE & DUAL-PORT TRANSFORMER MODULES

Ruggedized



1000B-5016F

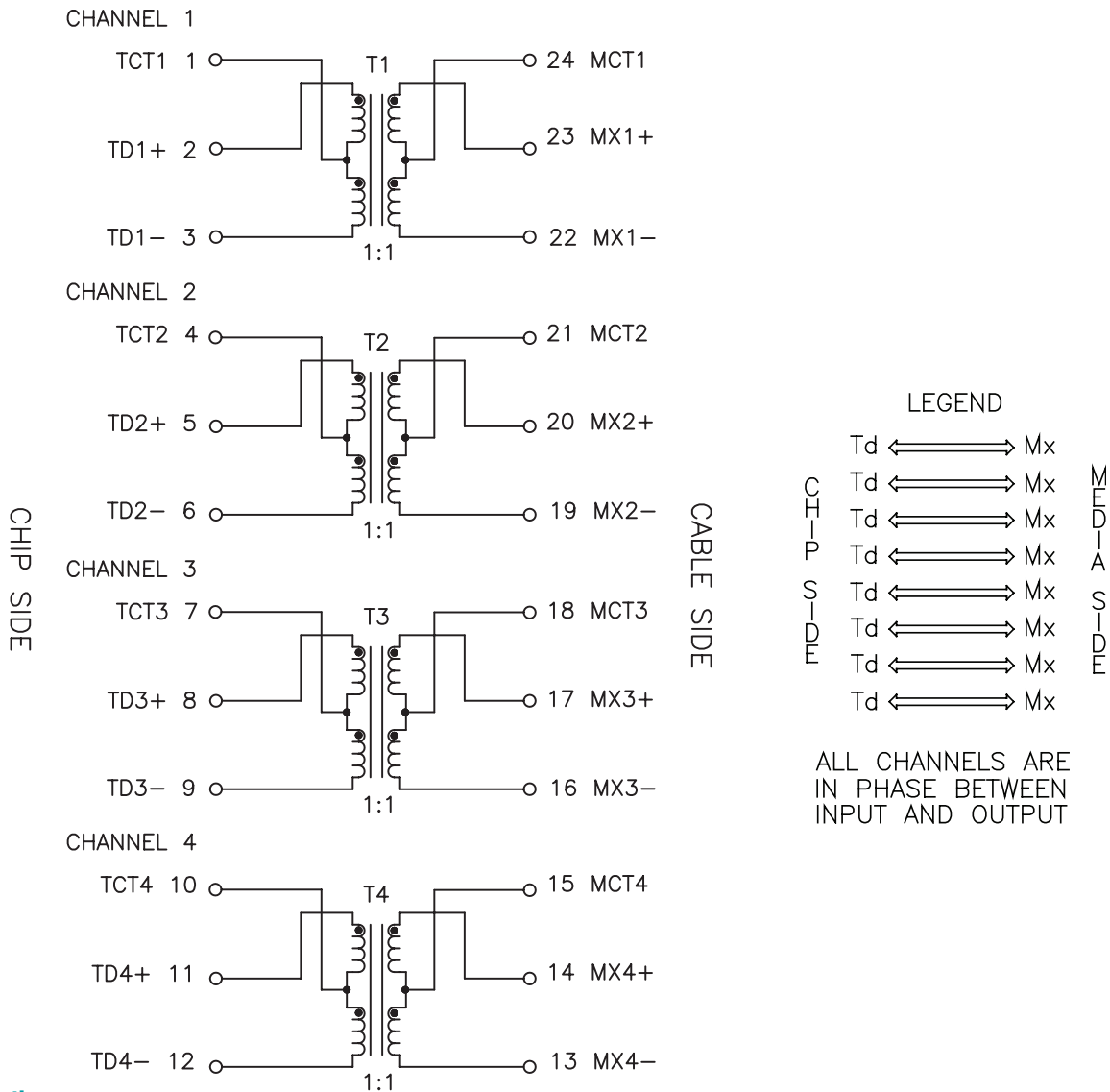

For More Information

Corporate Headquarters

PulseR, LLC

Two Pearl Buck Court

Bristol, PA 19007

U.S.A.

Tel: +1.215.781.6400

Fax: +1.215.781.6403

For Global Sales Representatives and Locations

Visit: <http://www.pulseruggedized.com>

Performance warranty of products offered on this data sheet is limited to the parameters specified. Data is subject to change without notice. Other brand and product names mentioned herein may be trademarks or registered trademarks of their respective owners. © Copyright, 2018. PulseR, LLC. All rights reserved.

X-ON Electronics

Largest Supplier of Electrical and Electronic Components

Click to view similar products for [Transformers Audio & Signal](#) category:

Click to view products by [Pulse](#) manufacturer:

Other Similar products are found below :

[CX2041NLT](#) [MGPWT-00449-P](#) [PL2615NL](#) [H1302FNLT](#) [H5012FNL](#) [H5077NLT](#) [H5084FNLT](#) [E4001NLT](#) [BX1194WNL](#) [HX2260FNL](#)
[HX5014FNL](#) [PA1136NL](#) [PA2437NL](#) [EX2024FNL](#) [T1049NL](#) [PE-65848FNLT](#) [PE-68023NL](#) [PH0905NL](#) [H1174FNL](#) [H1302FNL](#)
[H5015FNL](#) [H5062FNLT](#) [CX2047LNL](#) [MGPWT-00266-P](#) [MGPWT-00278-P](#) [MGPWT-00431-P](#) [BX1194WNLT](#) [HX5019FNL](#) [HX5084NL](#)
[TX1263NLT](#) [4-1879391-0](#) [PA0173NLT](#) [PA1284NLT](#) [T1142NL](#) [T60403-Y4021-X115](#) [HX6101FNL](#) [HX1148NL](#) [HX5020FNLT](#)
[HX5014FNLT](#) [T1124NL](#) [1879732-1](#) [B8846NL](#) [TX1267NLT](#) [TX1341NL](#) [H0013FNL](#) [H1270FNLT](#) [H2009FNL](#) [H5008FNLT](#) [H7008FNLT](#)
[H5004NLT](#)