

BSCH Series



The BSCH Series is a type of ceramic chip inductor produced using the multilayer technology. The series provides excellent Q factor and SRF characteristics and is suitable for high frequency applications.

Features

- RoHS compliant
- Excellent Q factor and SRF characteristics
- Small size of 1005/1608 is suitable for small portable devices
- Supports operating frequency up to 6GHz with nominal inductance values from 1.0nH to 470nH.

Applications

- RF resonance and impedance matching circuit
- RF and wireless communication
- Information technology equipment, computers, telecommunications, radar detectors, automotive electronics, cellular phones, pagers, PDAs, keyless remote systems
- L-C filter configurations

Product Identification

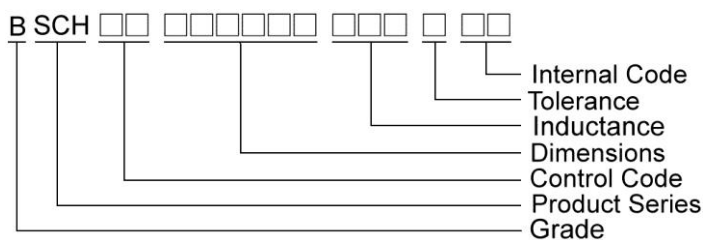

- Product series identification:
 - BSCH00060303 Top side half mark.
 - BSCH00100505 Top side full mark.
 - BSCH00160808 Top side full mark.

Shape and Dimensions

BSCH00060303

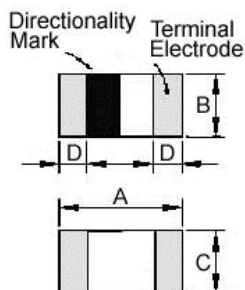

BSCH00100505 / 160808

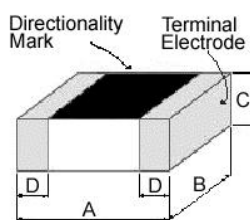

Recommended Pattern

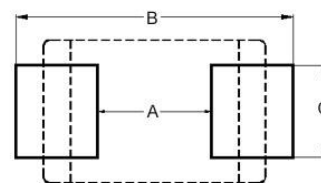

Dimensions in mm

TYPE	A	B	C	D
BSCH00060303	0.6±0.03	0.3±0.03	0.3±0.03	0.15±0.05
BSCH00100505	1.0±0.10	0.5±0.10	0.5±0.10	0.25±0.10
BSCH00160808	1.6±0.15	0.8±0.15	0.8±0.15	0.3±0.2

Dimensions in mm

TYPE	A	B	C
BSCH00060303	0.3	0.75 ~ 1.05	0.3
BSCH00100505	0.4	1.2 ~ 1.4	0.5
BSCH00160808	0.7 ~ 0.8	1.8 ~ 2.0	0.6 ~ 0.8

SMD Ceramic Multilayer Chip Inductors – BSCH Series

Electrical Characteristics

Part Number	Inductance (nH)	Tolerance (±%)	Test Frequency (MHz)	Q Min	SRF (MHz) Min	RDC (Ω) Max	Rated Current (mA) Max
BSCH000603031N0□00	1.0	±0.3nH	100	4	>10000	0.11	470
BSCH000603031N2□00	1.2	±0.3nH	100	4	>10000	0.12	450
BSCH000603031N5□00	1.5	±0.3nH	100	4	>10000	0.13	430
BSCH000603031N8□00	1.8	±0.3nH	100	4	>10000	0.16	390
BSCH000603032N0□00	2.0	±0.3nH	100	4	>10000	0.17	380
BSCH000603032N2□00	2.2	±0.3nH	100	4	8800	0.19	360
BSCH000603032N4□00	2.4	±0.3nH	100	4	8300	0.20	350
BSCH000603032N7□00	2.7	±0.3nH	100	4	7700	0.21	340
BSCH000603033N0□00	3.0	±0.3nH	100	4	7200	0.22	330
BSCH000603033N3□00	3.3	±0.3nH	100	4	6700	0.23	320
BSCH000603033N6□00	3.6	±0.3nH	100	4	6400	0.25	310
BSCH000603033N9□00	3.9	±0.3nH	100	4	6000	0.27	300
BSCH000603034N3□00	4.3	±0.3nH	100	4	5700	0.30	280
BSCH000603034N7□00	4.7	±0.3nH	100	4	5300	0.30	280
BSCH000603035N1□00	5.1	±0.3nH	100	4	5000	0.33	270
BSCH000603035N6□00	5.6	±0.3nH	100	4	4600	0.36	260
BSCH000603036N2□00	6.2	±0.3nH	100	4	4200	0.38	250
BSCH000603036N8□00	6.8	5	100	4	3900	0.39	250
BSCH000603037N5□00	7.5	5	100	4	3600	0.41	240
BSCH000603038N2□00	8.2	5	100	4	3400	0.45	230
BSCH000603039N1□00	9.1	5	100	4	3200	0.48	220
BSCH0006030310N□00	10	5	100	4	2900	0.51	220
BSCH0006030312N□00	12	5	100	4	2700	0.68	190
BSCH0006030315N□00	15	5	100	4	2300	0.71	180
BSCH0006030318N□00	18	5	100	4	2100	0.81	170
BSCH0006030322N□00	22	5	100	4	1800	1.00	150
BSCH0006030327N□00	27	5	100	4	1800	1.35	120
BSCH0006030333N□00	33	5	100	4	1700	1.47	110
BSCH0006030339N□00	39	5	100	4	1500	1.72	100
BSCH0006030347N□00	47	5	100	4	1300	1.90	100
BSCH0006030356N□00	56	5	100	4	1100	2.27	80
BSCH0006030368N□00	68	5	100	4	1100	2.66	80
BSCH0006030382N□00	82	5	100	4	1000	3.37	70

Note: When ordering, please specify tolerance code. Tolerance : S=±0.3nH , J=±5%

- Operating temperature range - 55°C ~ 125°C(Including self - temperature rise)
- Rate Current :Applied the current to coils, the temperature rise shall not be more than 30°C
- Residual impedance of short chip : 0.19nH
- Measure Equipment :
 L & Q : Agilent E4991A+Agilent 16197A
 SRF : Agilent E4991A or HP19196C
 RDC : HP4338B or CHEN HWA 502

SMD Ceramic Multilayer Chip Inductors – BSCH Series

Test Instruments : Agilent E4991A Material/Impedance Analyzer

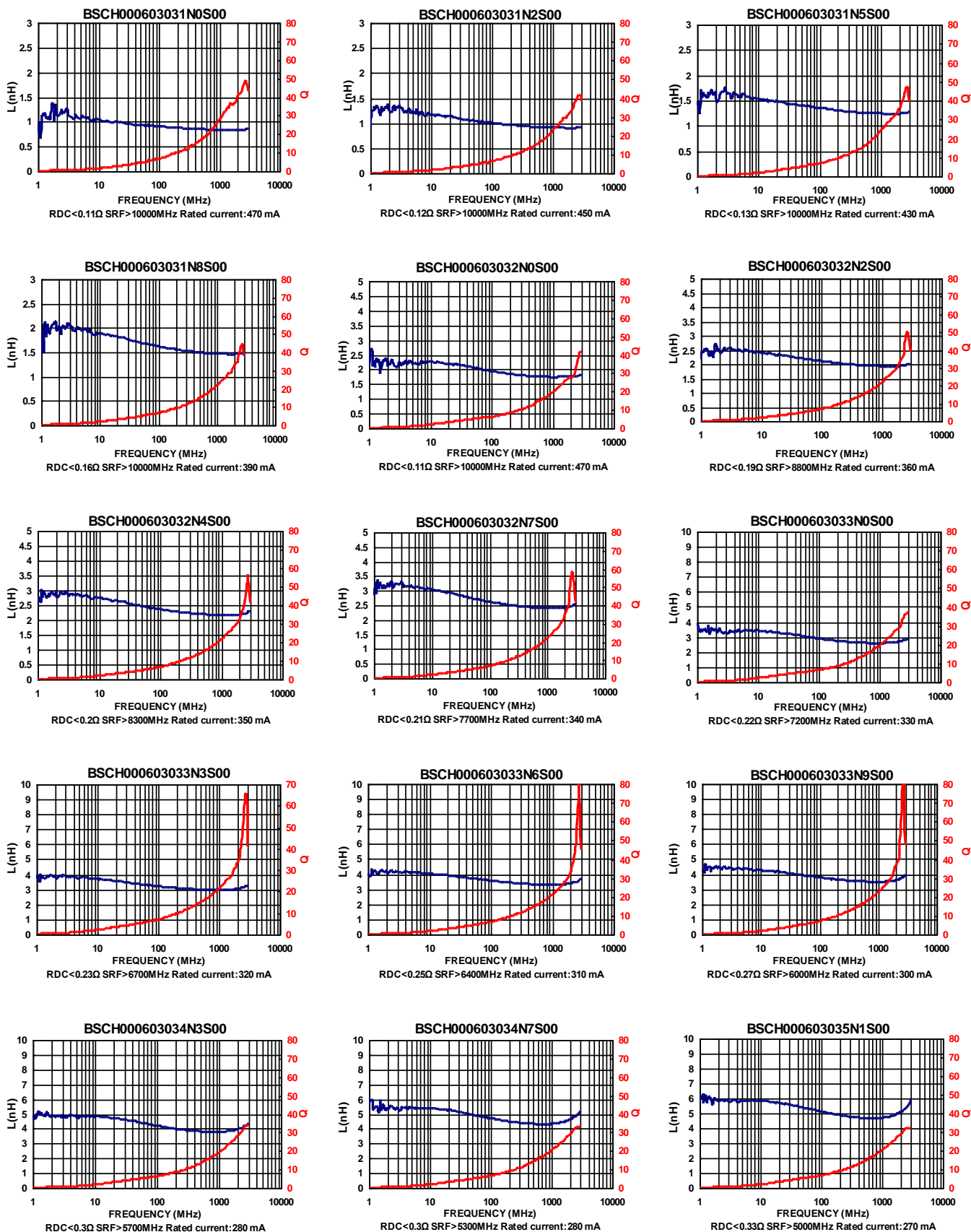

Please be sure to request approval specifications that provide further details of the products. Kindly note that the content of these specifications are subject to change or may be discontinued without prior notice. This product may not be designed/used in medical or high risk applications without Chilisin approval. Please contact our sales department before ordering.

SMD Ceramic Multilayer Chip Inductors – BSCH Series

Test Instruments : Agilent E4991A Material/Impedance Analyzer

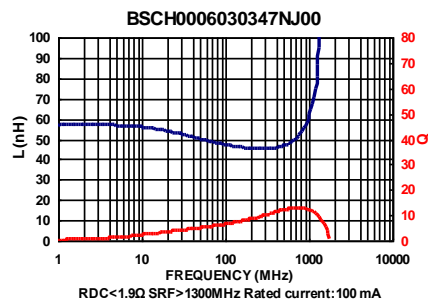
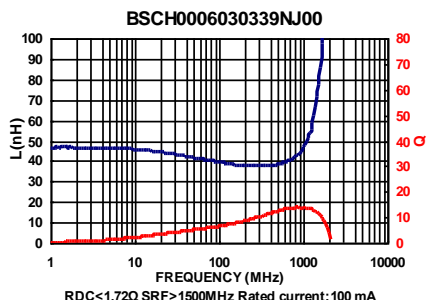
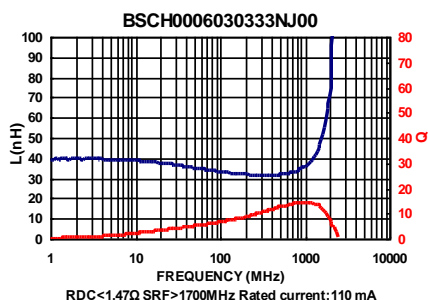
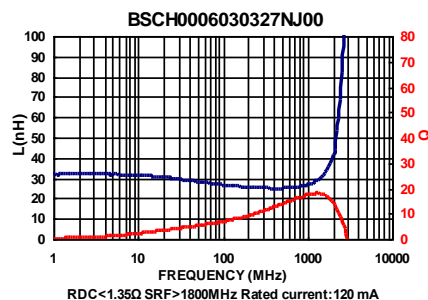
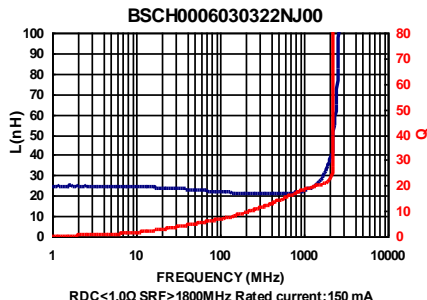
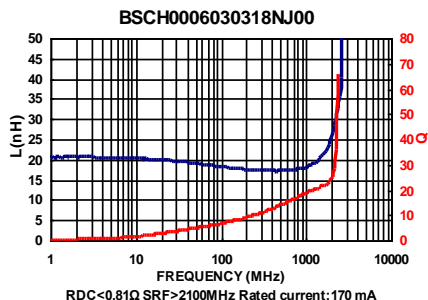
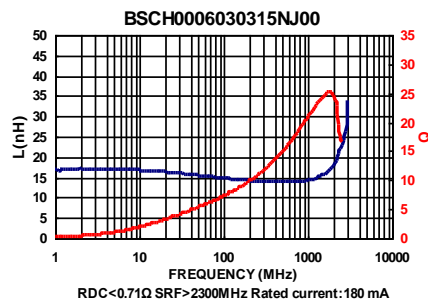
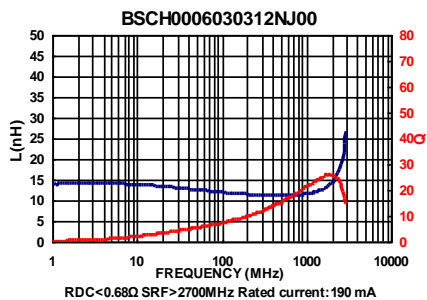
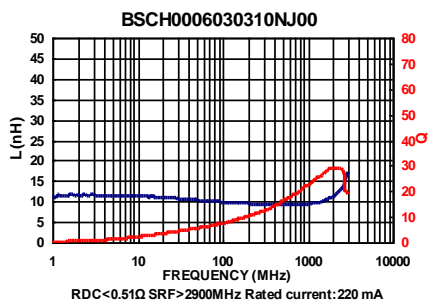
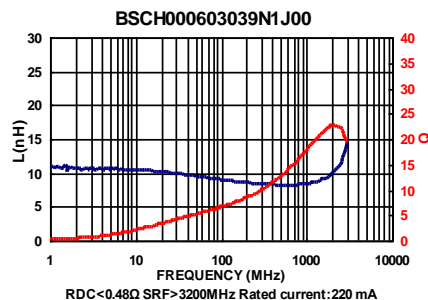
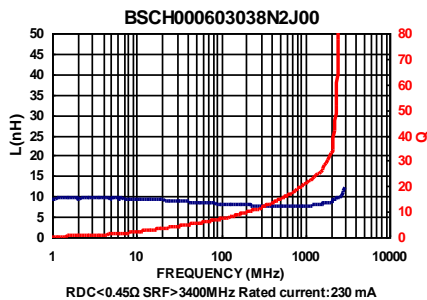
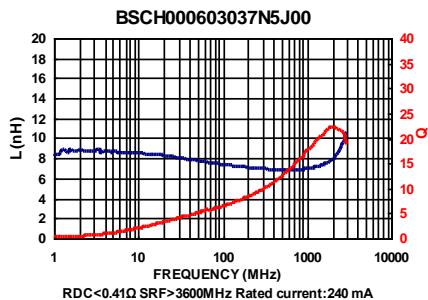
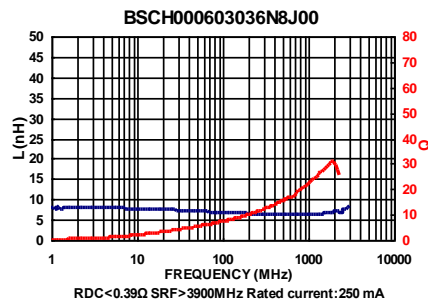
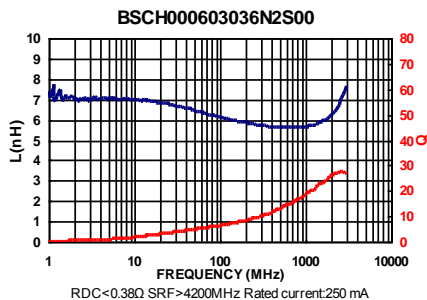
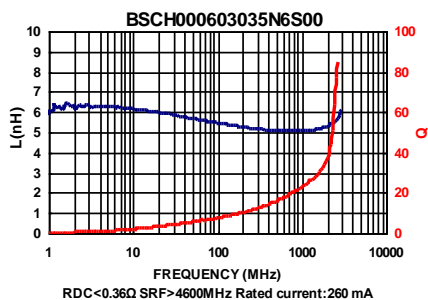

Please be sure to request approval specifications that provide further details of the products. Kindly note that the content of these specifications are subject to change or may be discontinued without prior notice. This product may not be designed/used in medical or high risk applications without Chilisin approval. Please contact our sales department before ordering.

SMD Ceramic Multilayer Chip Inductors – BSCH Series

Test Instruments : Agilent E4991A Material/Impedance Analyzer

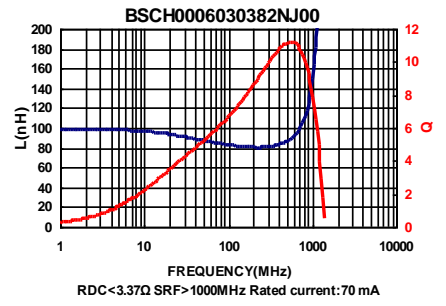
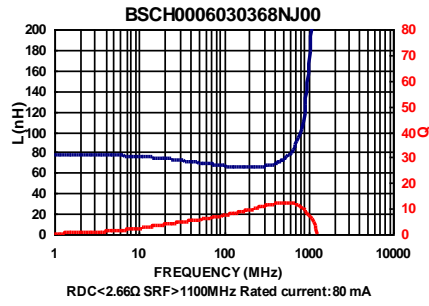
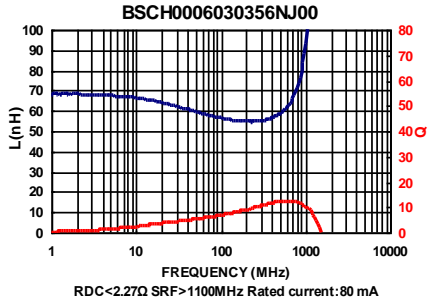

Please be sure to request approval specifications that provide further details of the products. Kindly note that the content of these specifications are subject to change or may be discontinued without prior notice. This product may not be designed/used in medical or high risk applications without Chilisin approval. Please contact our sales department before ordering.

SMD Multilayer Ceramic Chip Inductors – BSCH Series

Electrical Characteristics

Part Number	Inductance (nH)	Tolerance (±%)	Test Frequency (MHz)	Q Min	SRF (MHz) Typ.	RDC (Ω) Max	IDC (mA) Max
BSCH001005051N0□CS	1.0	±0.3nH	100	8	10000	0.07	400
BSCH001005051N1□CS	1.1	±0.3nH	100	8	10000	0.10	400
BSCH001005051N2□CS	1.2	±0.3nH	100	8	10000	0.09	400
BSCH001005051N3□CS	1.3	±0.3nH	100	8	9000	0.10	400
BSCH001005051N5□CS	1.5	±0.3nH	100	8	9000	0.10	400
BSCH001005051N6□CS	1.6	±0.3nH	100	8	8700	0.10	400
BSCH001005051N8□CS	1.8	±0.3nH	100	8	8700	0.10	400
BSCH001005052N0□CS	2.0	±0.3nH	100	8	8100	0.10	400
BSCH001005052N2□CS	2.2	±0.3nH	100	8	8100	0.12	400
BSCH001005052N4□CS	2.4	±0.3nH	100	8	7700	0.15	400
BSCH001005052N7□CS	2.7	±0.3nH	100	8	7700	0.15	400
BSCH001005053N0□CS	3.0	±0.3nH	100	8	6300	0.15	400
BSCH001005053N3□CS	3.3	±0.3nH/10	100	8	6300	0.15	400
BSCH001005053N6□CS	3.6	±0.3nH/10	100	8	6100	0.15	400
BSCH001005053N9□CS	3.9	±0.3nH/10	100	8	6100	0.18	400
BSCH001005054N3□CS	4.3	±0.3nH/10	100	8	6000	0.18	400
BSCH001005054N7□CS	4.7	±0.3nH/10	100	8	6000	0.18	400
BSCH001005055N0□CS	5.0	±0.3nH/10	100	8	5100	0.20	400
BSCH001005055N1□CS	5.1	±0.3nH/10	100	8	5300	0.20	400
BSCH001005055N6□CS	5.6	±0.3nH/10	100	8	5100	0.20	400
BSCH001005056N8□CS	6.8	5 / 10	100	8	4550	0.24	400
BSCH001005057N5□CS	7.5	5 / 10	100	8	4200	0.24	300
BSCH001005058N0□CS	8.0	5 / 10	100	8	4100	0.30	300
BSCH001005058N2□CS	8.2	5 / 10	100	8	4100	0.24	300
BSCH001005059N1□CS	9.1	5 / 10	100	8	3900	0.26	300
BSCH0010050510N□CS	10	5 / 10	100	8	3900	0.26	300
BSCH0010050512N□CS	12	5 / 10	100	8	3000	0.40	300
BSCH0010050515N□CS	15	5 / 10	100	8	2800	0.50	300
BSCH0010050518N□CS	18	5 / 10	100	8	2500	0.55	300
BSCH0010050522N□CS	22	5 / 10	100	8	2200	0.70	300
BSCH0010050524N□CS	24	5 / 10	100	8	2100	0.70	300
BSCH0010050527N□CS	27	5 / 10	100	8	2000	0.80	300
BSCH0010050533N□CS	33	5 / 10	100	8	1800	0.9	200
BSCH0010050539N□CS	39	5 / 10	100	8	1600	1.0	150
BSCH0010050547N□CS	47	5 / 10	100	8	1400	1.2	150

Note: When ordering, please specify tolerance code. Tolerance : S=±0.3nH , J=±5% , K=±10%

- Operating temperature range - 55°C ~ 125°C(Including self - temperature rise)
- IDC : Applied the current to coils, the inductance shall be less than 10% initial value
- Residual impedance of short chip : 0nH
- Measure Equipment :
L & Q : Agilent E4991A+Agilent 16197A
SRF : HP8753D
RDC : HP4338B or CHEN HWA 502

SMD Multilayer Ceramic Chip Inductors – BSCH Series

Electrical Characteristics

Part Number	Inductance (nH)	Tolerance (±%)	Test Frequency (MHz)	Q Min	SRF (MHz) Typ.	RDC (Ω) Max	IDC (mA) Max
BSCH0010050556N□CS	56	5 / 10	100	8	1300	1.3	150
BSCH0010050568N□CS	68	5 / 10	100	8	1100	1.5	100
BSCH0010050575N□CS	75	5 / 10	100	8	1080	1.5	100
BSCH0010050582N□CS	82	5 / 10	100	8	1000	1.6	100
BSCH00100505R10□CS	100	5 / 10	100	8	900	2.0	100
BSCH00100505R12□CS	120	5 / 10	100	8	800	2.2	100
BSCH00100505R15□CS	150	5 / 10	100	8	700	3.5	100
BSCH00100505R18□CS	180	5 / 10	100	8	600	3.8	100
BSCH00100505R22□CS	220	5 / 10	100	8	500	4.2	100
BSCH00100505R27□CS	270	5 / 10	100	8	500	4.8	100

Note: When ordering, please specify tolerance code. Tolerance : S=±0.3nH , J=±5% , K=±10%

- Operating temperature range - 55°C ~ 125°C(Including self - temperature rise)
- IDC : Applied the current to coils, the inductance shall be less than 10% initial value
- Residual impedance of short chip : 0nH
- Measure Equipment :
L & Q : Agilent E4991A+Agilent 16197A
SRF : HP8753D
RDC : HP4338B or CHEN HWA 502

Test Instruments : Agilent E4991A Material/Impedance Analyzer

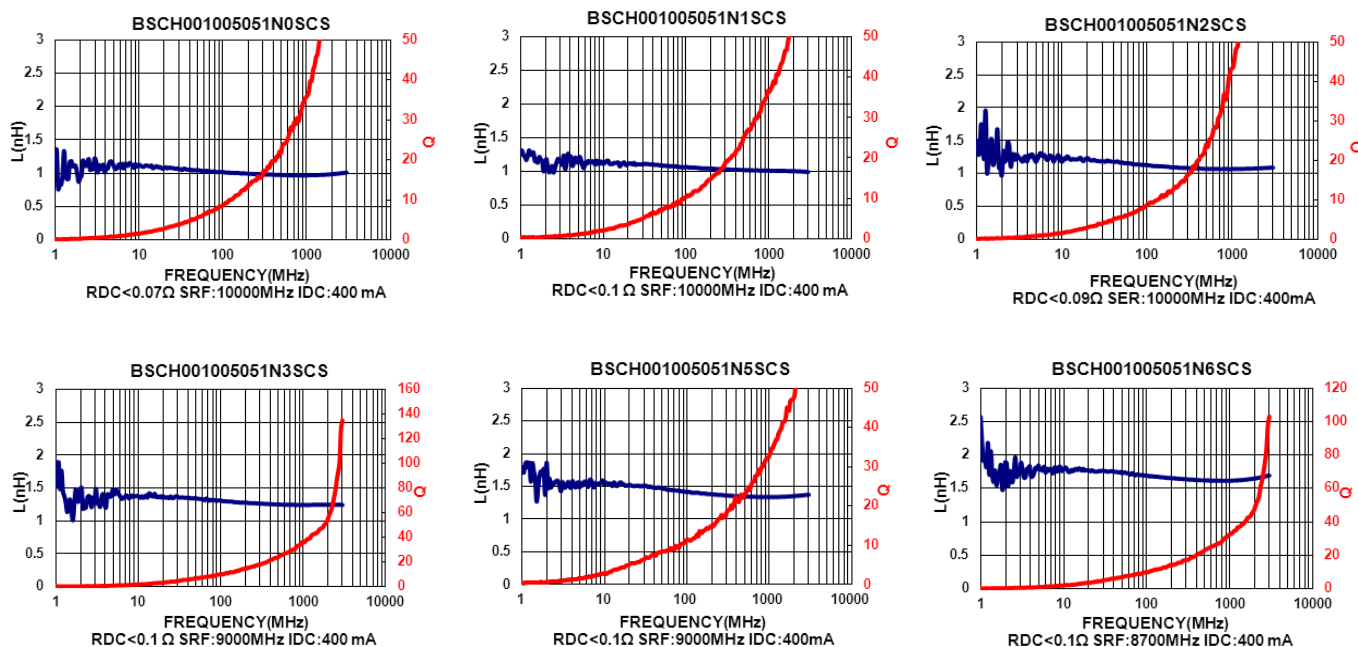

Please be sure to request approval specifications that provide further details of the products. Kindly note that the content of these specifications are subject to change or may be discontinued without prior notice. This product may not be designed/used in medical or high risk applications without Chilisin approval. Please contact our sales department before ordering.

SMD Multilayer Ceramic Chip Inductors – BSCH Series

Test Instruments : Agilent E4991A Material/Impedance Analyzer

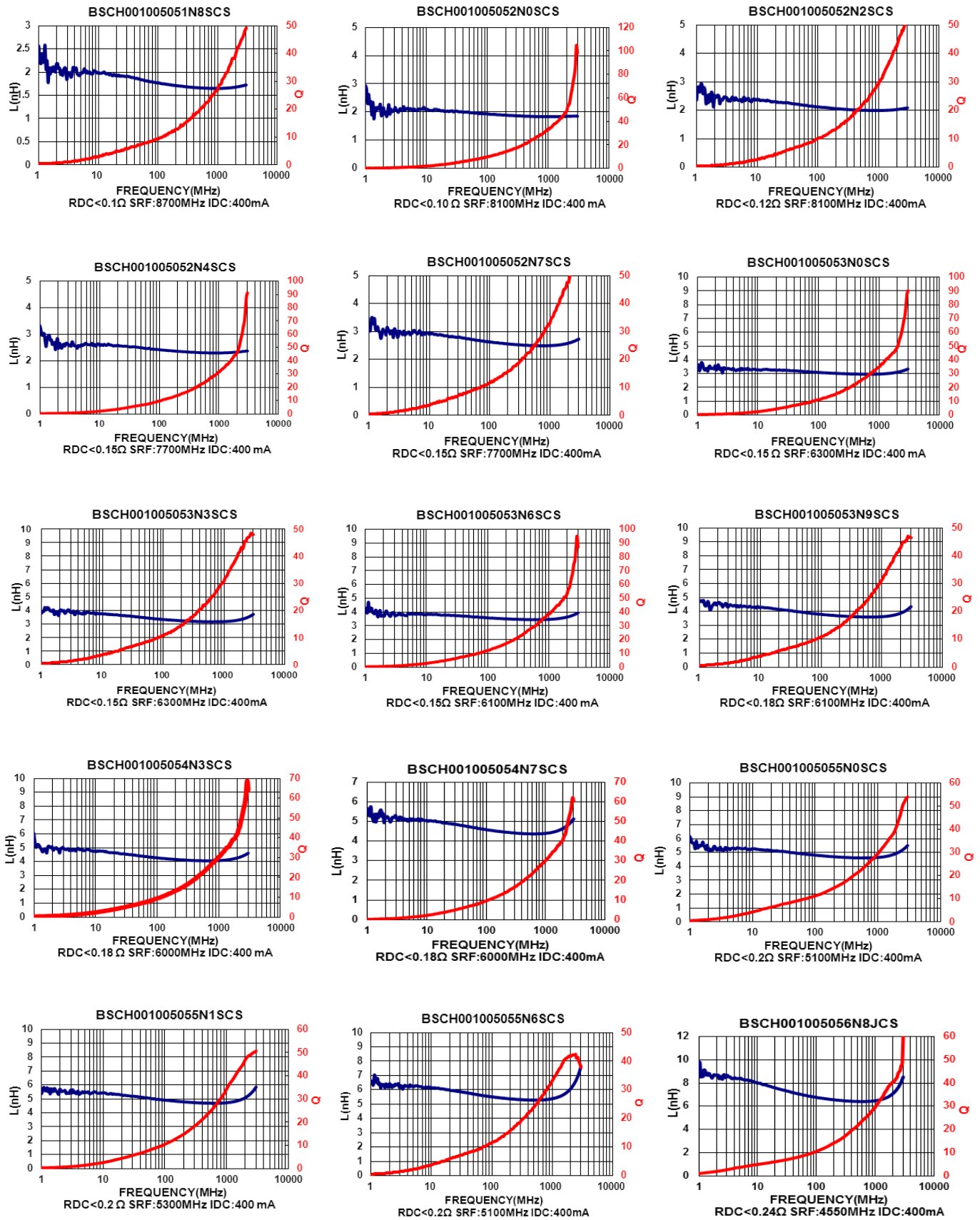

Please be sure to request approval specifications that provide further details of the products. Kindly note that the content of these specifications are subject to change or may be discontinued without prior notice. This product may not be designed/used in medical or high risk applications without Chilisin approval. Please contact our sales department before ordering.

SMD Multilayer Ceramic Chip Inductors – BSCH Series

Test Instruments : Agilent E4991A Material/Impedance Analyzer

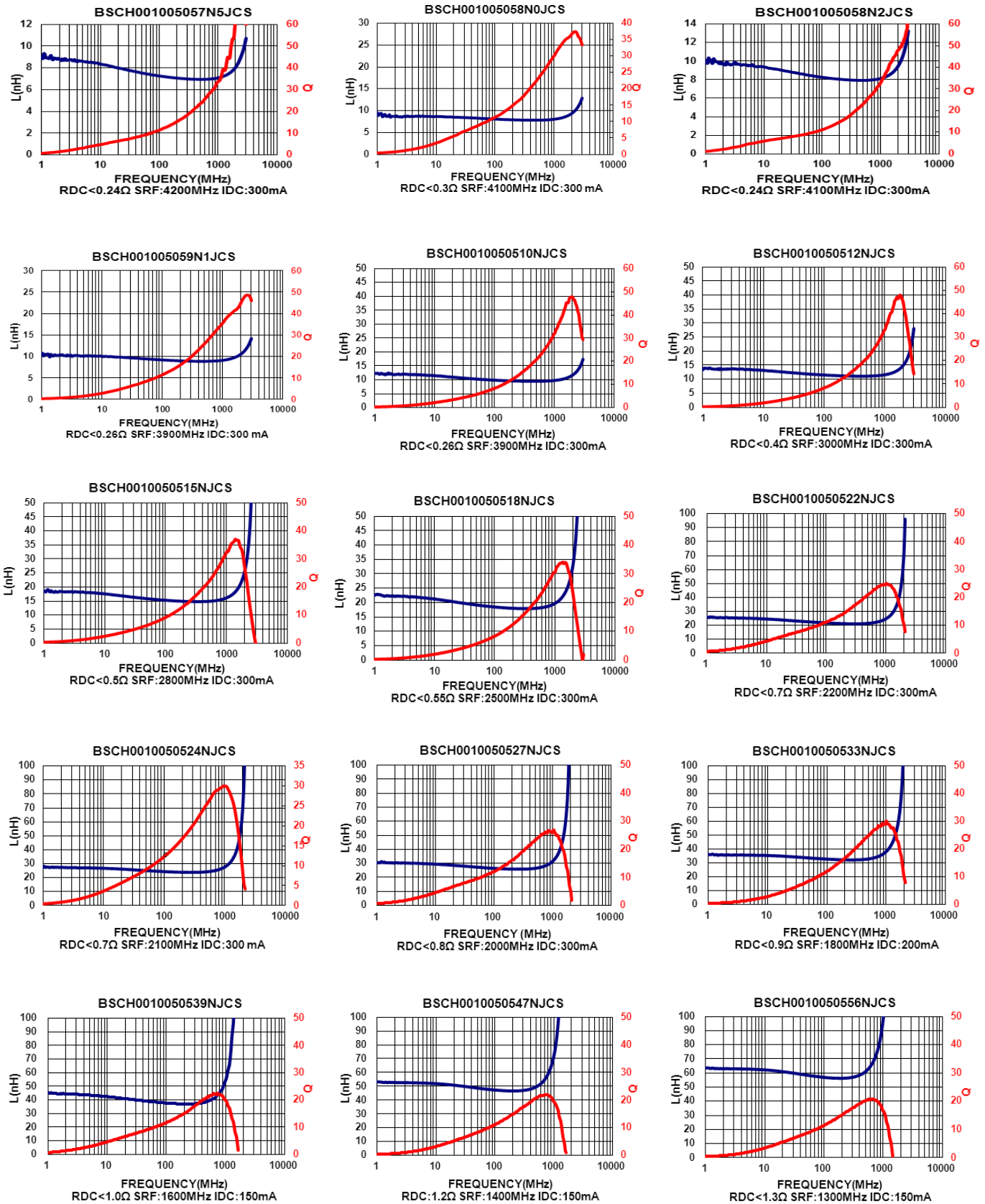

Please be sure to request approval specifications that provide further details of the products. Kindly note that the content of these specifications are subject to change or may be discontinued without prior notice. This product may not be designed/used in medical or high risk applications without Chilisin approval. Please contact our sales department before ordering.

SMD Multilayer Ceramic Chip Inductors – BSCH Series

Test Instruments : Agilent E4991A Material/Impedance Analyzer

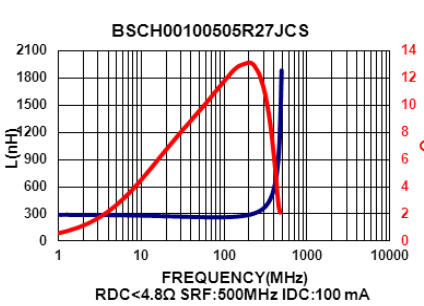
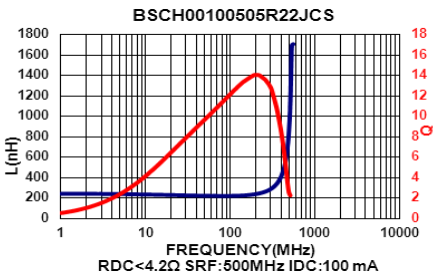
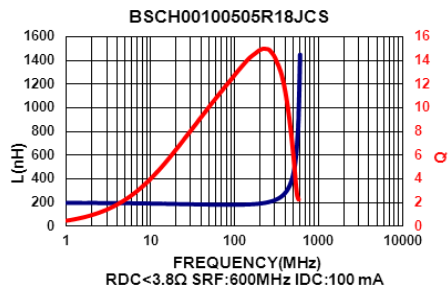
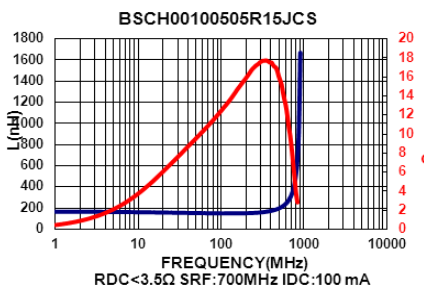
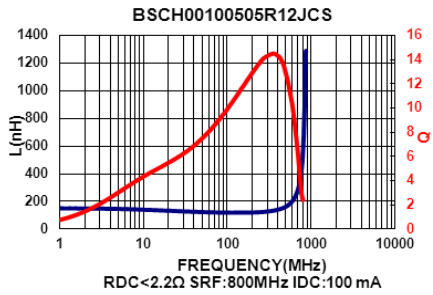
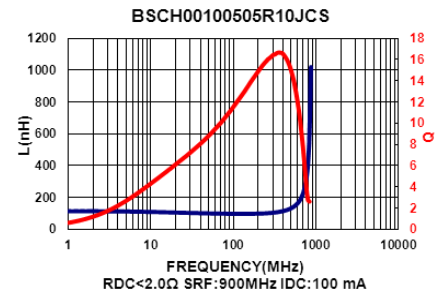
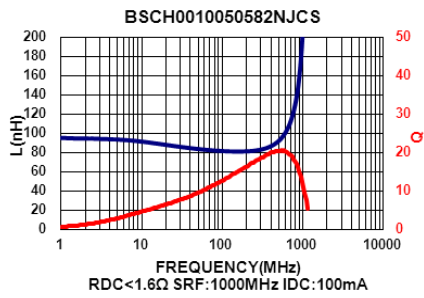
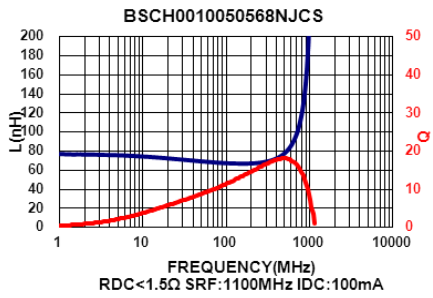

Please be sure to request approval specifications that provide further details of the products. Kindly note that the content of these specifications are subject to change or may be discontinued without prior notice. This product may not be designed/used in medical or high risk applications without Chilisin approval. Please contact our sales department before ordering.

SMD Multilayer Ceramic Chip Inductors - BSCH Series

Electrical Characteristics

Part Number	Inductance (nH)	Tolerance (±%)	Test Frequency (MHz)	Q Min	SRF (MHz) Typ.	RDC (Ω) Max	Rated Current (mA) Max
BSCH001005051N0□CP	1.0	±0.3nH	100	8	10000	0.07	400
BSCH001005051N1□CP	1.1	±0.3nH	100	8	10000	0.10	400
BSCH001005051N2□CP	1.2	±0.3nH	100	8	10000	0.09	400
BSCH001005051N3□CP	1.3	±0.3nH	100	8	9000	0.10	400
BSCH001005051N5□CP	1.5	±0.3nH	100	8	9000	0.10	400
BSCH001005051N6□CP	1.6	±0.3nH	100	8	8700	0.10	400
BSCH001005051N8□CP	1.8	±0.3nH	100	8	8700	0.10	400
BSCH001005052N0□CP	2.0	±0.3nH	100	8	8100	0.10	400
BSCH001005052N2□CP	2.2	±0.3nH	100	8	8100	0.12	400
BSCH001005052N4□CP	2.4	±0.3nH	100	8	7700	0.15	400
BSCH001005052N7□CP	2.7	±0.3nH	100	8	7700	0.15	400
BSCH001005053N0□CP	3.0	±0.3nH	100	8	6300	0.15	400
BSCH001005053N3□CP	3.3	±0.3nH	100	8	6300	0.15	400
BSCH001005053N6□CP	3.6	±0.3nH	100	8	6100	0.15	400
BSCH001005053N9□CP	3.9	±0.3nH	100	8	6100	0.18	400
BSCH001005054N3□CP	4.3	±0.3nH	100	8	6000	0.18	400
BSCH001005054N7□CP	4.7	±0.3nH	100	8	6000	0.18	400
BSCH001005055N1□CP	5.1	±0.3nH	100	8	5300	0.20	400
BSCH001005055N6□CP	5.6	±0.3nH	100	8	5100	0.20	400
BSCH001005056N2□CP	6.2	±0.3nH/5/10	100	8	4500	0.22	400
BSCH001005056N8□CP	6.8	5 / 10	100	8	4550	0.24	400
BSCH001005057N5□CP	7.5	5 / 10	100	8	4200	0.24	300
BSCH001005058N2□CP	8.2	5 / 10	100	8	4100	0.24	300
BSCH001005059N1□CP	9.1	5 / 10	100	8	3900	0.26	300
BSCH0010050510N□CP	10	5 / 10	100	8	3900	0.26	300
BSCH0010050512N□CP	12	5 / 10	100	8	3000	0.28	300
BSCH0010050515N□CP	15	5 / 10	100	8	2500	0.32	300
BSCH0010050518N□CP	18	5 / 10	100	8	2200	0.36	300
BSCH0010050522N□CP	22	5 / 10	100	8	1900	0.42	300
BSCH0010050527N□CP	27	5 / 10	100	8	1700	0.46	300
BSCH0010050533N□CP	33	5 / 10	100	8	1600	0.58	200
BSCH0010050539N□CP	39	5 / 10	100	8	1200	0.65	200
BSCH0010050547N□CP	47	5 / 10	100	8	1000	0.72	200
BSCH0010050556N□CP	56	5 / 10	100	8	800	0.82	200
BSCH0010050568N□CP	68	5 / 10	100	8	800	0.92	180
BSCH0010050582N□CP	82	5 / 10	100	8	700	1.20	150

Note: When ordering, please specify tolerance code. Tolerance : C=±0.2nH , S=±0.3nH , J=±5% , K=±10%

- Operating temperature range - 55°C ~ 125°C(Including self - temperature rise)
- Rate Current : Applied the current to coils, the temperature rise shall not be more than 30°C
- Residual impedance of short chip : 0nH
- Measure Equipment :
L & Q : Agilent E4991A+Agilent 16197A
SRF : HP8753D
RDC : HP4338B or CHEN HWA 502

Please be sure to request approval specifications that provide further details of the products. Kindly note that the content of these specifications are subject to change or may be discontinued without prior notice. This product may not be designed/used in medical or high risk applications without Chilisin approval. Please contact our sales department before ordering.

SMD Multilayer Ceramic Chip Inductors - BSCH Series

Test Instruments : Agilent E4991A Material/Impedance Analyzer

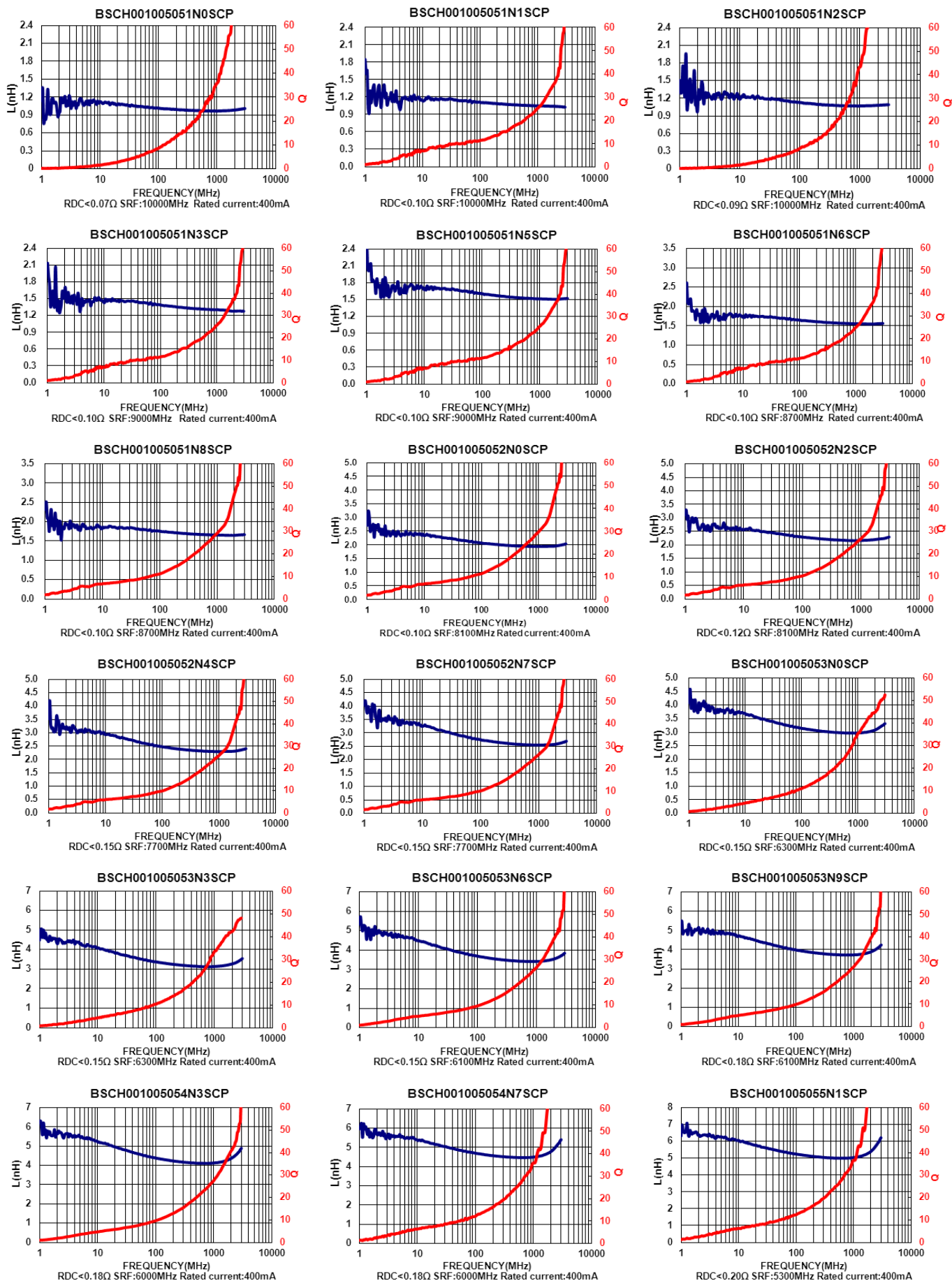

Please be sure to request approval specifications that provide further details of the products. Kindly note that the content of these specifications are subject to change or may be discontinued without prior notice. This product may not be designed/used in medical or high risk applications without Chilisin approval. Please contact our sales department before ordering.

SMD Multilayer Ceramic Chip Inductors - BSCH Series

Test Instruments : Agilent E4991A Material/Impedance Analyzer

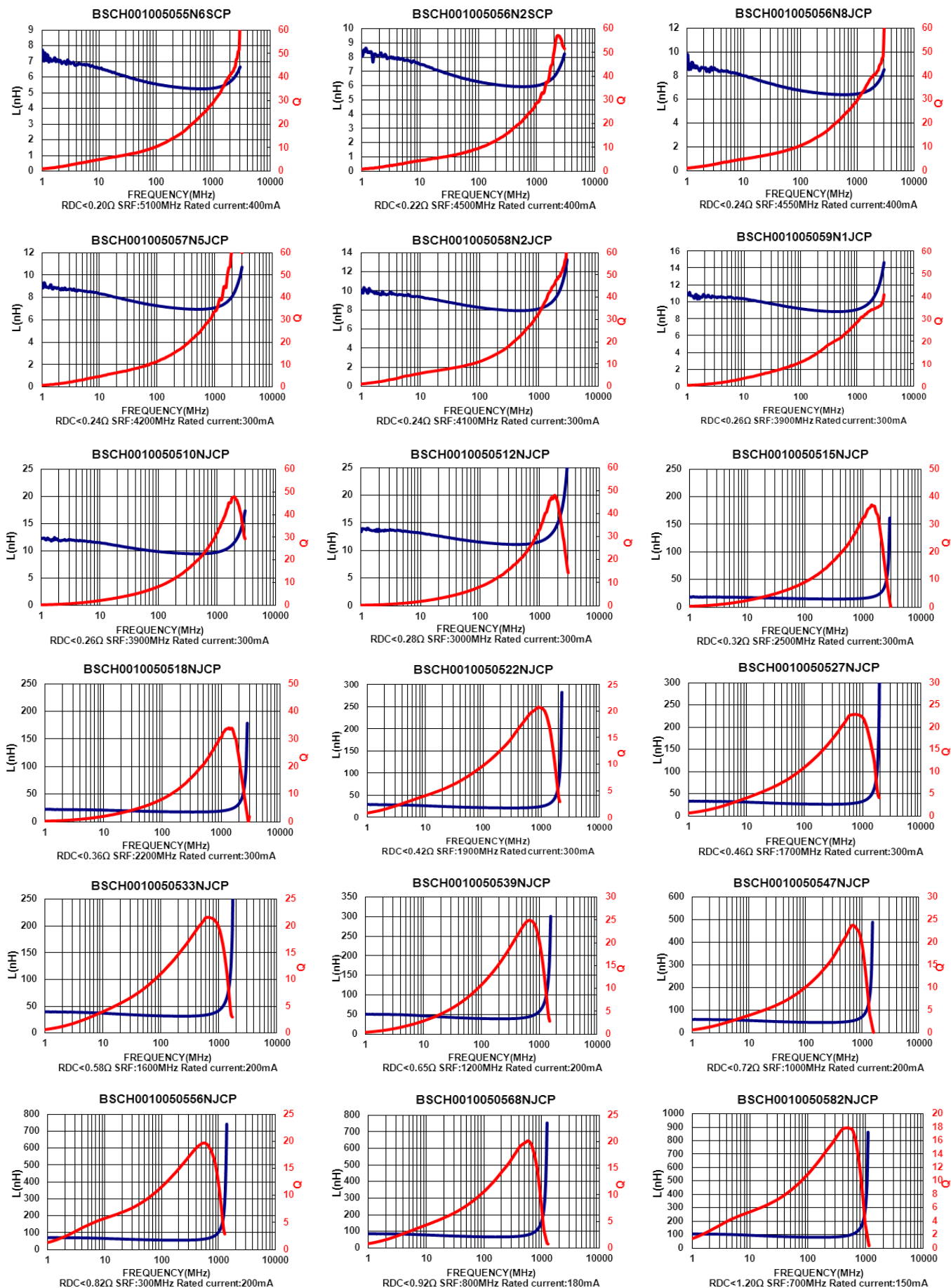

Please be sure to request approval specifications that provide further details of the products. Kindly note that the content of these specifications are subject to change or may be discontinued without prior notice. This product may not be designed/used in medical or high risk applications without Chilisin approval. Please contact our sales department before ordering.

SMD Multilayer Ceramic Chip Inductors – BSCH Series

Electrical Characteristics

Part Number	Inductance (nH)	Tolerance (±%)	Test Frequency (MHz)	Q Min	SRF (MHz) Min	RDC (Ω) Max	IDC (mA) Max
BSCH001005051N0□SM	1.0	±0.3nH	100	8	10000	0.07	400
BSCH001005051N2□SM	1.2	±0.3nH	100	8	6000	0.10	400
BSCH001005051N5□SM	1.5	±0.3nH	100	8	6000	0.10	400
BSCH001005051N6□SM	1.6	±0.3nH	100	8	6000	0.10	400
BSCH001005051N8□SM	1.8	±0.3nH	100	8	6000	0.10	400
BSCH001005052N0□SM	2.0	±0.3nH	100	8	6000	0.12	400
BSCH001005052N2□SM	2.2	±0.3nH	100	8	6000	0.15	400
BSCH001005052N4□SM	2.4	±0.3nH	100	8	6000	0.15	400
BSCH001005052N7□SM	2.7	±0.3nH	100	8	6000	0.15	400
BSCH001005053N0□SM	3.0	±0.3nH	100	8	6000	0.15	400
BSCH001005053N3□SM	3.3	±0.3nH	100	8	6000	0.15	400
BSCH001005053N6□SM	3.6	±0.3nH	100	8	6000	0.15	400
BSCH001005053N9□SM	3.9	±0.3nH	100	8	6000	0.19	400
BSCH001005054N3□SM	4.3	±0.3nH	100	8	6000	0.20	400
BSCH001005054N7□SM	4.7	±0.3nH	100	8	6000	0.20	400
BSCH001005055N1□SM	5.1	±0.3nH	100	8	6000	0.20	400
BSCH001005055N6□SM	5.6	±0.3nH	100	8	5300	0.20	400
BSCH001005056N2□SM	6.2	5	100	8	4300	0.25	400
BSCH001005056N8□SM	6.8	5	100	8	4200	0.25	400
BSCH001005057N5□SM	7.5	5	100	8	3900	0.25	400
BSCH001005058N2□SM	8.2	5	100	8	3600	0.30	300
BSCH001005059N1□SM	9.1	5	100	8	3400	0.34	300
BSCH0010050510N□SM	10	5	100	8	3200	0.35	300
BSCH0010050512N□SM	12	5	100	8	2800	0.35	300
BSCH0010050515N□SM	15	5	100	8	2300	0.46	300

Note: When ordering, please specify tolerance code. Tolerance : S=±0.3nH , J=±5%

- Operating temperature range - 55°C ~ 125°C(Including self - temperature rise)
- IDC : Applied the current to coils, the inductance shall be less than 10% initial value
- Residual impedance of short chip : 0.55nH
- Measure Equipment :
L & Q : Agilent E4991A+Agilent 16197A
SRF : HP8753D
RDC : HP4338B or CHEN HWA 502

SMD Multilayer Ceramic Chip Inductors – BSCH Series

Test Instruments : Agilent E4991A Material/Impedance Analyzer

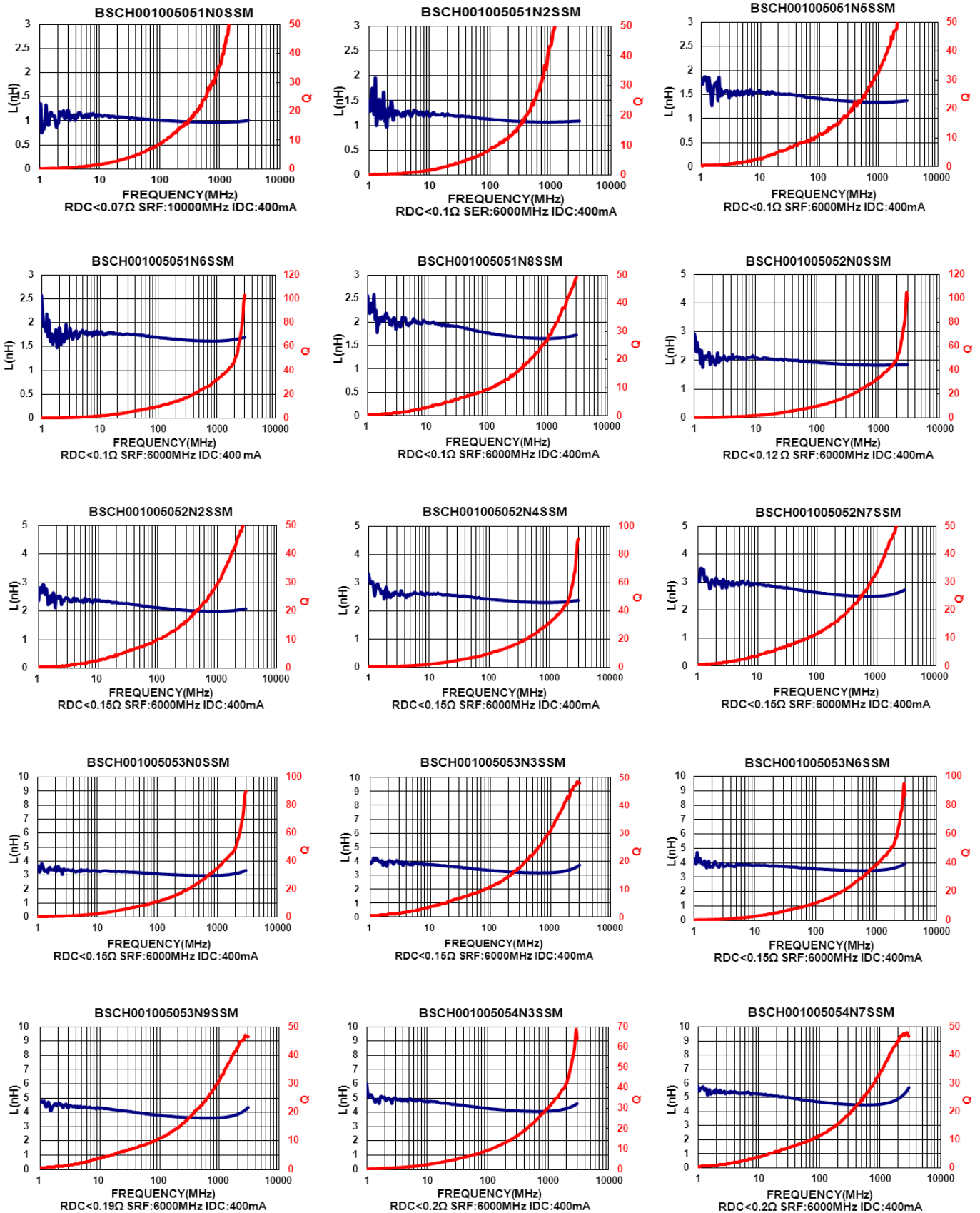

Please be sure to request approval specifications that provide further details of the products. Kindly note that the content of these specifications are subject to change or may be discontinued without prior notice. This product may not be designed/used in medical or high risk applications without Chilisin approval. Please contact our sales department before ordering.

SMD Multilayer Ceramic Chip Inductors – BSCH Series

Test Instruments : Agilent E4991A Material/Impedance Analyzer

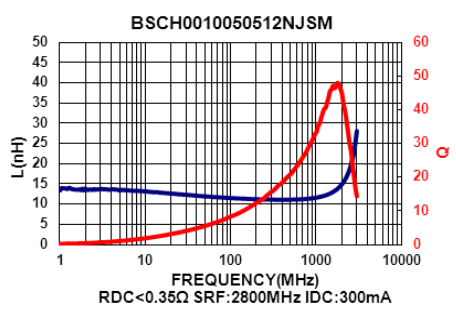
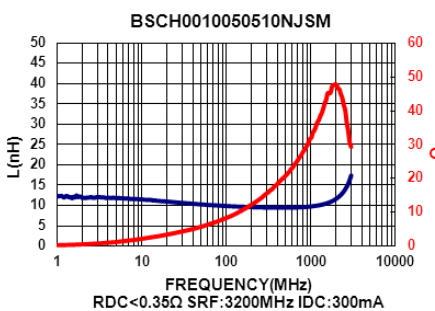
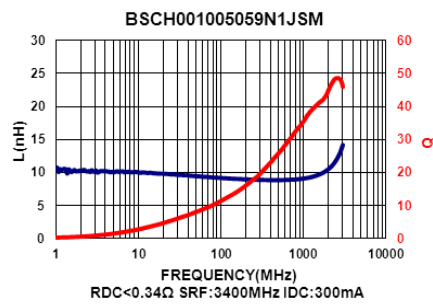
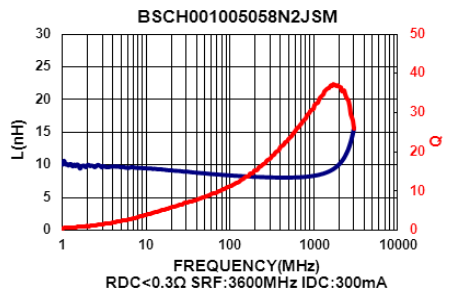
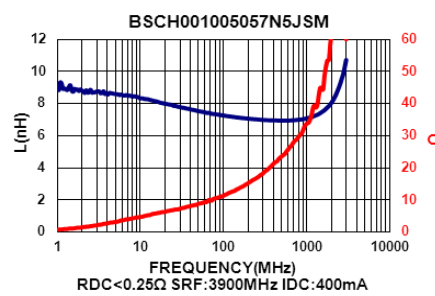
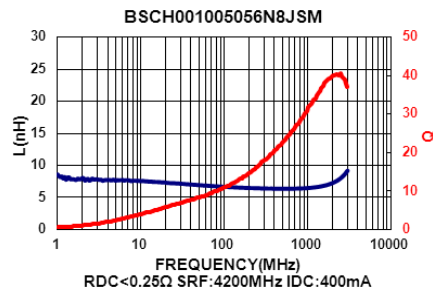
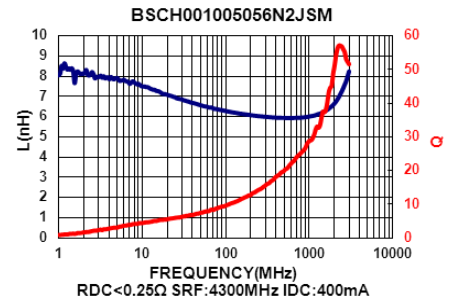
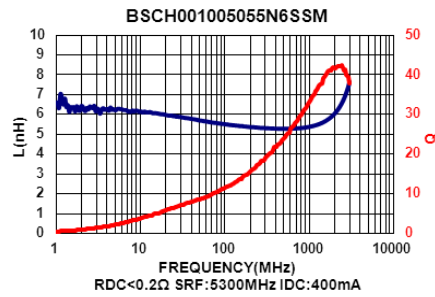
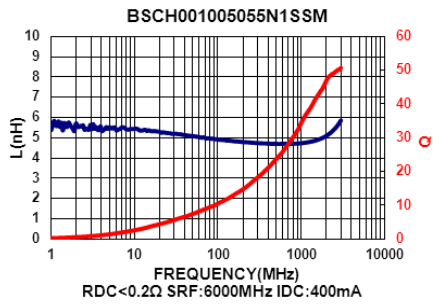

Please be sure to request approval specifications that provide further details of the products. Kindly note that the content of these specifications are subject to change or may be discontinued without prior notice. This product may not be designed/used in medical or high risk applications without Chilisin approval. Please contact our sales department before ordering.

SMD Multilayer Ceramic Chip Inductors – BSCH Series

Electrical Characteristics

Part Number	Inductance (nH)	Tolerance (±%)	Test Frequency (MHz)	Q Min	SRF (MHz) Typ.	RDC (Ω) Max	IDC (mA) Max
BSCH001608081N0S00	1.0	±0.3nH	100	8	10000	0.10	600
BSCH001608081N2S00	1.2	±0.3nH	100	8	10000	0.10	600
BSCH001608081N5S00	1.5	±0.3nH	100	8	8000	0.10	600
BSCH001608081N6S00	1.6	±0.3nH	100	8	8000	0.10	600
BSCH001608081N8S00	1.8	±0.3nH	100	8	8000	0.10	600
BSCH001608082N2S00	2.2	±0.3nH	100	8	7200	0.10	600
BSCH001608082N7S00	2.7	±0.3nH	100	10	6200	0.10	600
BSCH001608083N0S00	3.0	±0.3nH	100	10	5200	0.12	600
BSCH001608083N3□00	3.3	±0.3nH/10	100	10	5200	0.12	600
BSCH001608083N6S00	3.6	±0.3nH	100	10	5000	0.14	600
BSCH001608083N9□00	3.9	±0.3nH/10	100	10	5000	0.14	600
BSCH001608084N3□00	4.3	±0.3nH/10	100	10	4750	0.16	600
BSCH001608084N7□00	4.7	±0.3nH/10	100	10	4750	0.16	600
BSCH001608085N1□00	5.1	±0.3nH/10	100	10	4100	0.18	600
BSCH001608085N6□00	5.6	±0.3nH/10	100	10	4100	0.18	600
BSCH001608086N2□00	6.2	5 / 10	100	10	3750	0.22	600
BSCH001608086N8□00	6.8	5 / 10	100	10	3750	0.22	600
BSCH001608087N5□00	7.5	5 / 10	100	10	3300	0.24	600
BSCH001608088N2□00	8.2	5 / 10	100	10	3300	0.24	600
BSCH0016080810N□00	10	5 / 10	100	12	3000	0.26	600
BSCH0016080812N□00	12	5 / 10	100	12	2600	0.28	600
BSCH0016080815N□00	15	5 / 10	100	12	2500	0.32	600
BSCH0016080816N□00	16	5 / 10	100	12	2400	0.35	600
BSCH0016080818N□00	18	5 / 10	100	12	2400	0.35	600
BSCH0016080822N□00	22	5 / 10	100	12	2000	0.40	500
BSCH0016080827N□00	27	5 / 10	100	12	1900	0.45	500
BSCH0016080833N□00	33	5 / 10	100	12	1600	0.55	400
BSCH0016080839N□00	39	5 / 10	100	12	1400	0.60	400
BSCH0016080847N□00	47	5 / 10	100	12	1300	0.70	400
BSCH0016080856N□00	56	5 / 10	100	12	1100	0.75	400
BSCH0016080862N□00	62	5 / 10	100	12	1050	0.85	400
BSCH0016080868N□00	68	5 / 10	100	12	1050	0.85	400
BSCH0016080875N□00	75	5 / 10	100	12	900	1.00	300
BSCH0016080882N□00	82	5 / 10	100	12	900	1.00	300

Note: When ordering, please specify tolerance code. Tolerance : S=±0.3nH , J=±5% , K=±10%

- Operating temperature range - 55°C ~ 125°C(Including self - temperature rise)
- IDC : Applied the current to coils, the inductance shall be less than 10% initial value
- Residual impedance of short chip : 0nH
- Measure Equipment :
L & Q : Agilent E4991A+Agilent 16197A
SRF : HP8753D
RDC : HP4338B or CHEN HWA 502

Please be sure to request approval specifications that provide further details of the products. Kindly note that the content of these specifications are subject to change or may be discontinued without prior notice. This product may not be designed/used in medical or high risk applications without Chilisin approval. Please contact our sales department before ordering.

SMD Multilayer Ceramic Chip Inductors – BSCH Series

Electrical Characteristics

Part Number	Inductance (nH)	Tolerance (±%)	Test Frequency (MHz)	Q Min	SRF (MHz) Typ.	RDC (Ω) Max	IDC (mA) Max
BSCH00160808R10□00	100	5 / 10	100	12	770	1.20	300
BSCH00160808R12□00	120	5 / 10	50	8	650	1.30	300
BSCH00160808R15□00	150	5 / 10	50	8	550	1.70	250
BSCH00160808R18□00	180	5 / 10	50	8	520	1.90	250
BSCH00160808R22□00	220	5 / 10	50	8	500	2.00	250
BSCH00160808R27□00	270	5 / 10	50	8	470	2.20	150
BSCH00160808R33□00	330	5 / 10	50	8	320	2.80	100
BSCH00160808R39□00	390	5 / 10	50	8	300	3.00	100

Note: When ordering, please specify tolerance code. Tolerance : S=±0.3nH , J=±5% , K=±10%

- Operating temperature range - 55°C ~ 125°C(Including self - temperature rise)
- IDC : Applied the current to coils, the inductance shall be less than 10% initial value
- Residual impedance of short chip : 0nH
- Measure Equipment :
 L & Q : Agilent E4991A+Agilent 16197A
 SRF : HP8753D
 RDC : HP4338B or CHEN HWA 502

Test Instruments : Agilent E4991A Material/Impedance Analyzer

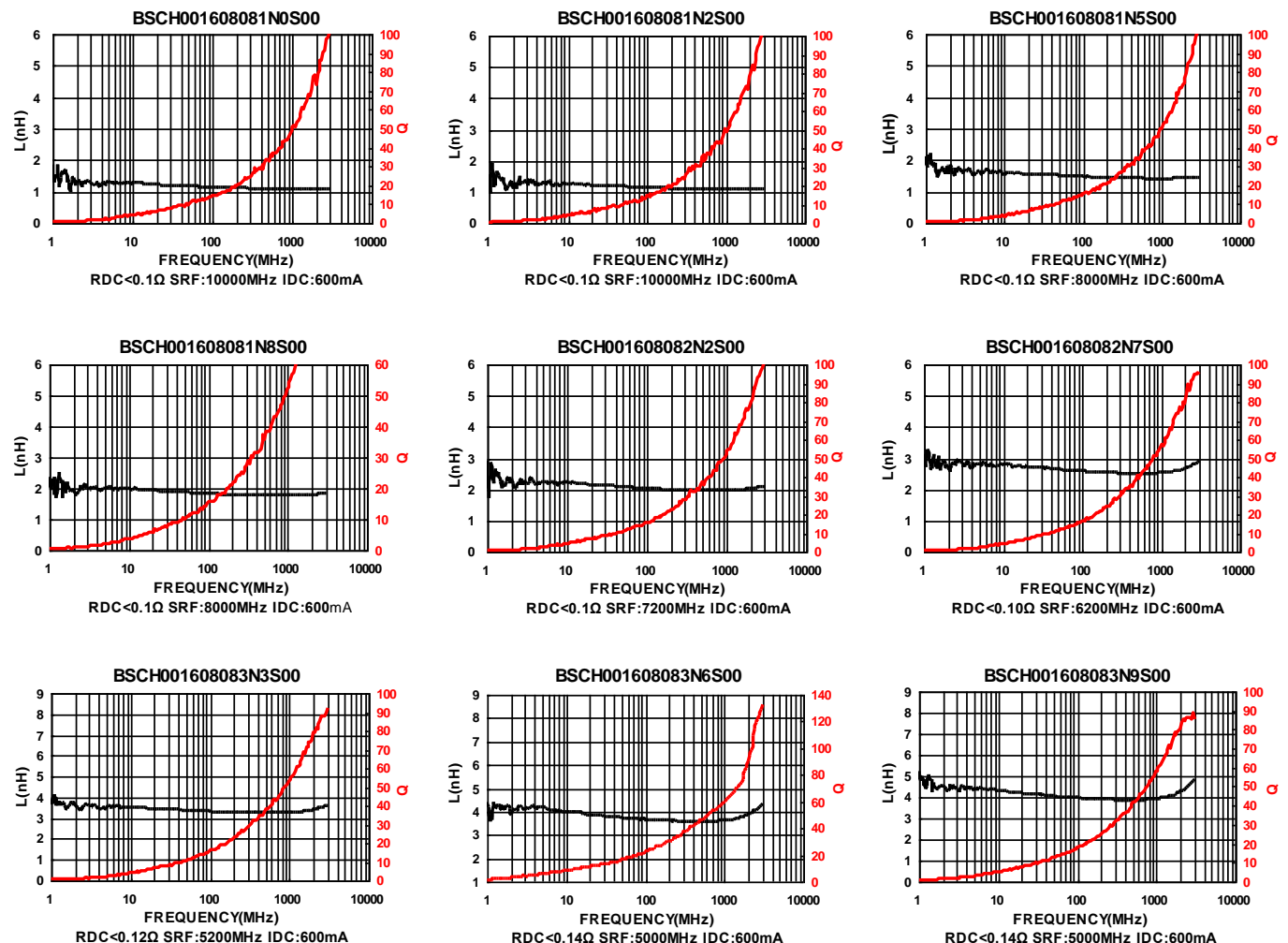

Please be sure to request approval specifications that provide further details of the products. Kindly note that the content of these specifications are subject to change or may be discontinued without prior notice. This product may not be designed/used in medical or high risk applications without Chilsin approval. Please contact our sales department before ordering.

SMD Multilayer Ceramic Chip Inductors – BSCH Series

Test Instruments : Agilent E4991A Material/Impedance Analyzer

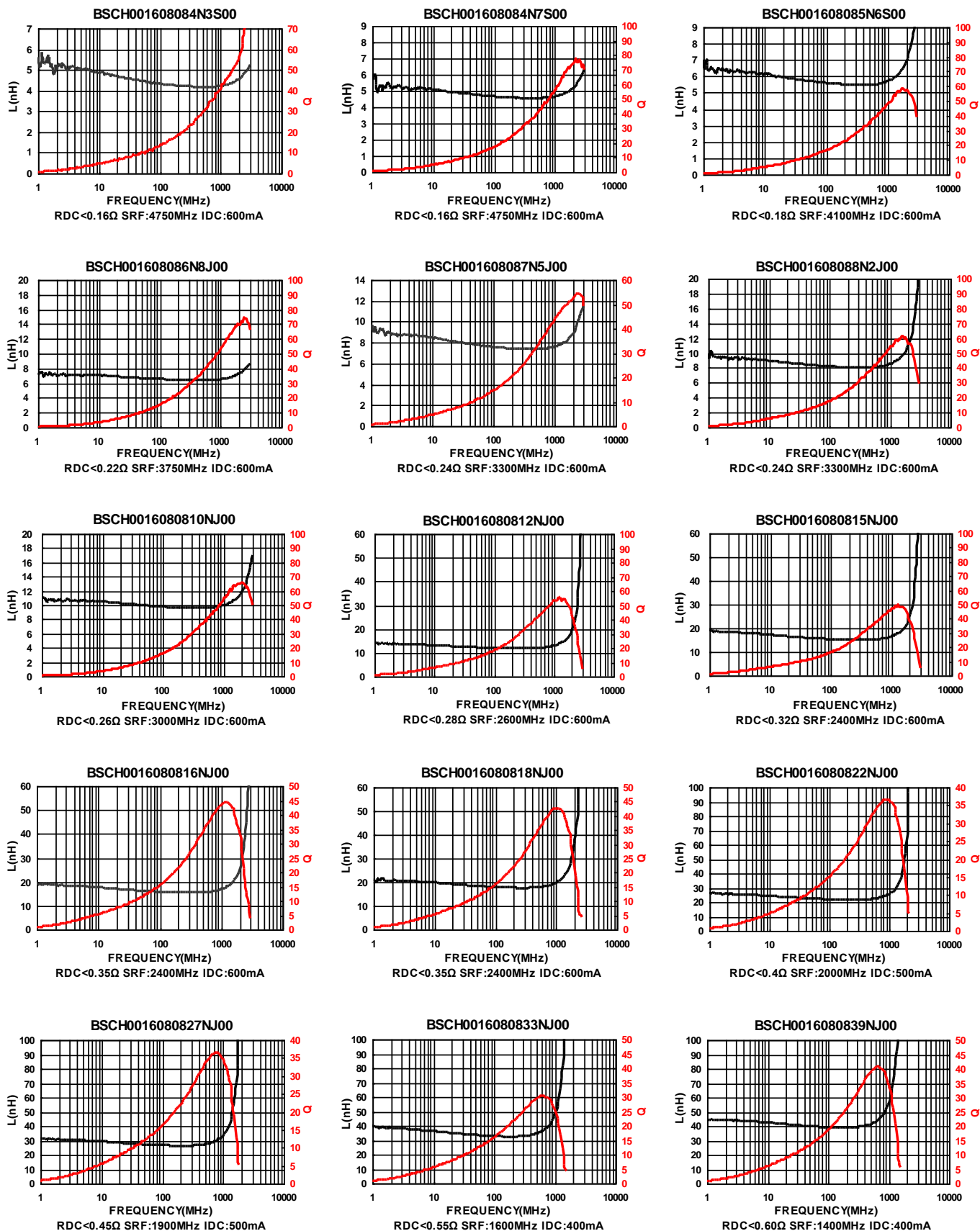

Please be sure to request approval specifications that provide further details of the products. Kindly note that the content of these specifications are subject to change or may be discontinued without prior notice. This product may not be designed/used in medical or high risk applications without Chilisin approval. Please contact our sales department before ordering.

SMD Multilayer Ceramic Chip Inductors – BSCH Series

Test Instruments : Agilent E4991A Material/Impedance Analyzer

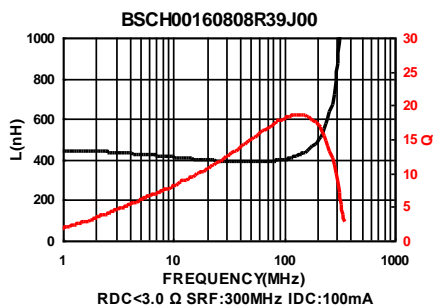
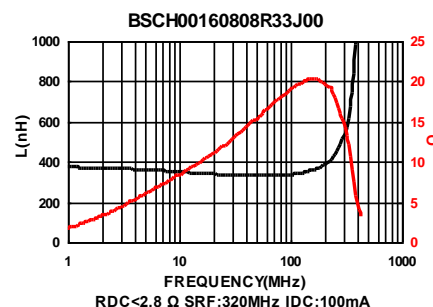
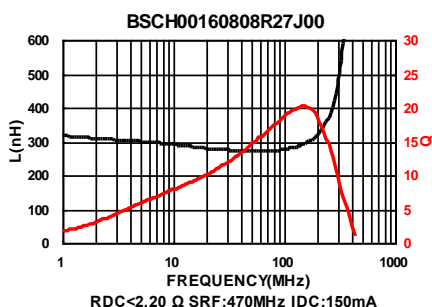
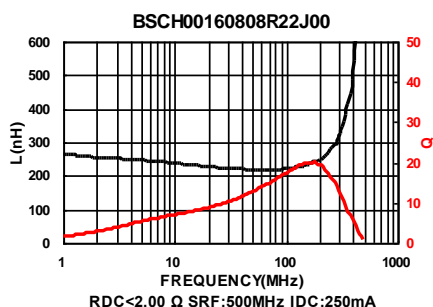
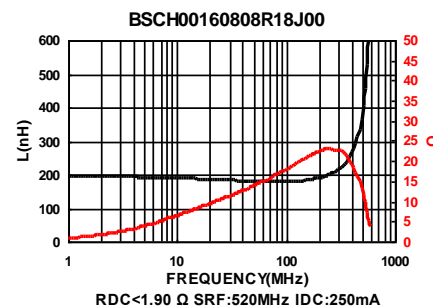
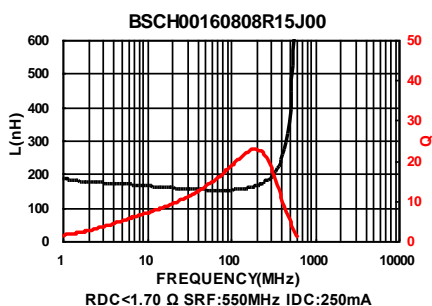
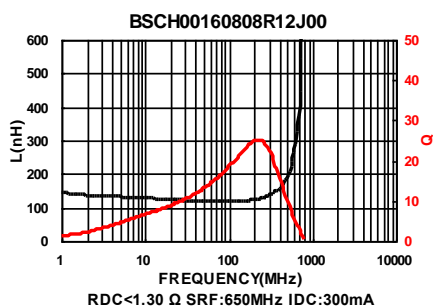
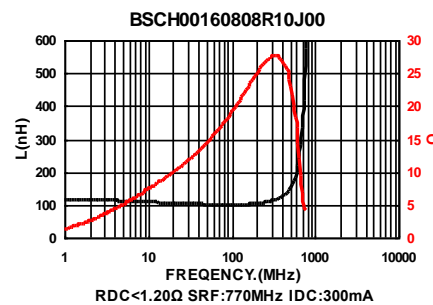
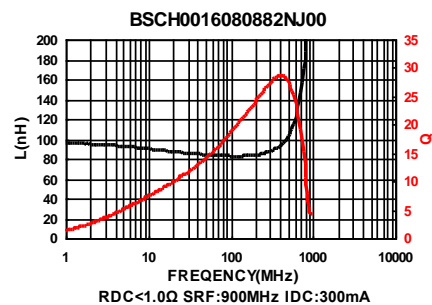
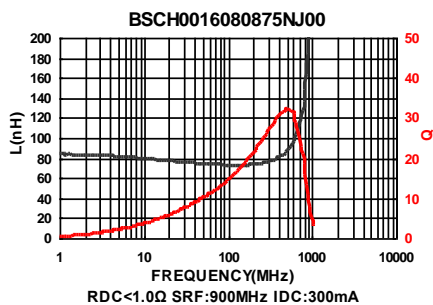
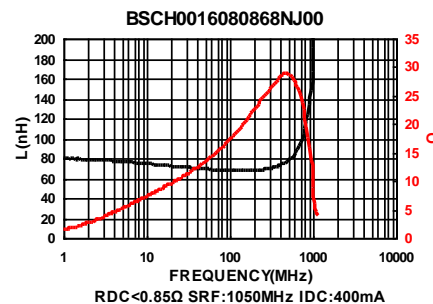
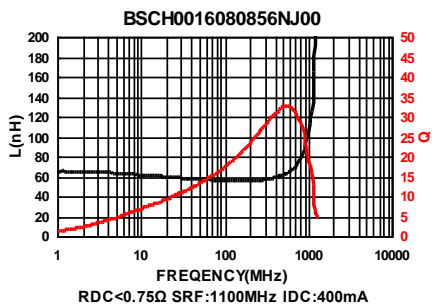
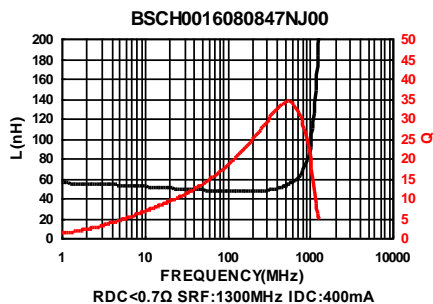

Please be sure to request approval specifications that provide further details of the products. Kindly note that the content of these specifications are subject to change or may be discontinued without prior notice. This product may not be designed/used in medical or high risk applications without Chilisin approval. Please contact our sales department before ordering.

SMD Ceramic Multilayer Chip Inductors - BSCH Series

Packaging Specifications

Tape Dimensions

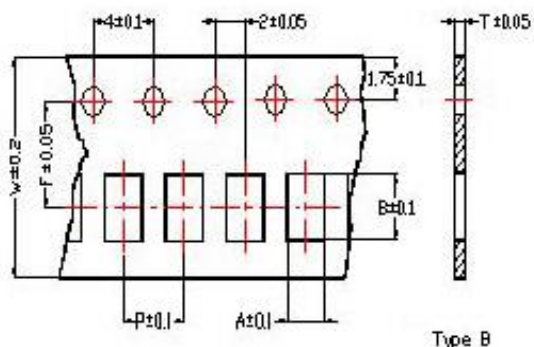

Tape Material

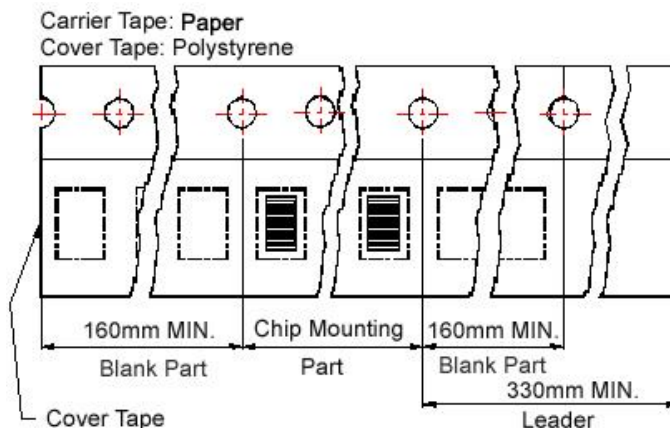

Reel Dimensions

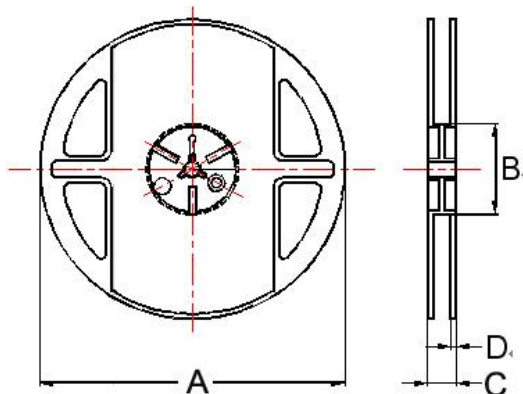

Dimensions in mm

TYPE	Tape Dimensions						Reel Dimensions				Quantity PCS / Reel
	A	B	T	W	P	F	A	B	C	D	
BSCH00060303	0.37	0.67	0.42	8	2	3.5	180	60	13	1.5	15000
BSCH00100505	0.62	1.12	0.60	8	2	3.5	178	60	12	1.5	10000
BSCH00160808	1.00	1.80	0.95	8	4	3.5	178	60	12	1.5	4000

X-ON Electronics

Largest Supplier of Electrical and Electronic Components

Click to view similar products for [Fixed Inductors](#) category:

Click to view products by [Pulse manufacturer](#):

Other Similar products are found below :

[CR43NP-680KC](#) [CR54NP-820KC](#) [CR54NP-8R5MC](#) [CTX32CT-100](#) [70F224AI](#) [MGDQ4-00004-P](#) [MHL1ECTTP18NJ](#) [MHL1JCTTD12NJ](#)
[PE-51506NL](#) [PE-53601NL](#) [PE-53602NL](#) [PE-53630NL](#) [PE-53824SNLT](#) [PE-62892NL](#) [PE-92100NL](#) [PG0434.801NLT](#) [PG0936.113NLT](#)
[9310-16](#) [PM06-2N7](#) [PM06-39NJ](#) [A01TK](#) [1206CS-471XJ](#) [HC2-2R2TR](#) [HC2LP-R47-R](#) [HC3-2R2-R](#) [1206CS-151XG](#) [RCH664NP-140L](#)
[RCH664NP-4R7M](#) [RCH8011NP-221L](#) [RCP1317NP-332L](#) [RCP1317NP-391L](#) [RCR1010NP-470M](#) [RCR110DNP-331L](#) [DH2280-4R7M](#)
[DS1608C-106](#) [ASPI-4020HI-R10M-T](#) [B10TJ](#) [B82477P4333M](#) [B82498B3101J000](#) [B82498B3680J000](#) [ELJ-RE27NJF2](#) [1812CS-153XJ](#)
[1812CS-183XJ](#) [1812CS-223XJ](#) [1812LS-104XJ](#) [1812LS-105XJ](#) [1812LS-124XJ](#) [1812LS-154XJ](#) [1812LS-223XJ](#) [1812LS-224XJ](#)