

# LAMINATED Transformers



## PRODUCT OVERVIEW: LAMINATED TRANSFORMERS

Pulse offers power ratings from 1.1 VA to 175 VA, open frame transformers, with a wide variety of domestic and international agency approvals. Pulse is truly the one-stop-shop for all your 50/60 Hz transformer needs.

This catalog serves as an overview for the Pulse Laminated Transformers product line. Contact Pulse Power Applications Engineering by e-mail [prodinfo\\_power@pulseelectronics.com](mailto:prodinfo_power@pulseelectronics.com), for more information.

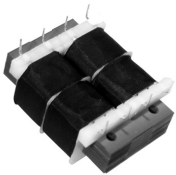

### Low Profile Plug-In

- Print circuit mounting
- 1500 V, primary to secondary isolation
- Low profile design
- Vacuum impregnated
- Baked resin

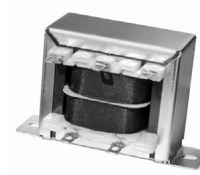

### Chasis Tran

- Channel frame
- 2500 V, primary
- Non-concentric
- Vacuum impregnated
- Baked resin

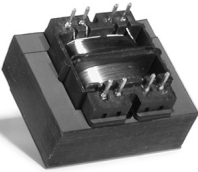

### International PC Plug-In

- PC board plug-in mounting
- Dual bobbin, high (4000 V) primary to secondary isolation
- Non-concentric design
- Vacuum impregnated
- Baked resin



### International High Power

- Chassis mounting
- Dual bobbin; high (4000 V) primary to secondary isolation
- Non-concentric design
- Vacuum impregnated
- Baked resin

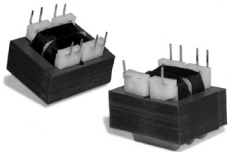

### Split Bobbin, Horizontal Plug-In

- Print circuit mounting
- 2500 Vrms Hipot
- Non-concentric design
- Vacuum impregnated
- Baked resin

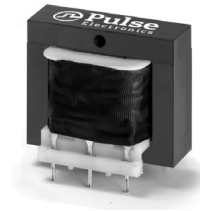

### Concentric, Vertical Profile, PC Plug-In

- Industry standard footprint
- 1500 V primary to secondary isolation
- Concentric vertical mount
- Vacuum impregnated
- Baked resin

# Laminated Transformers

Low Frequency, Open-Style Laminated,  
Low Profile, Plug-In Series

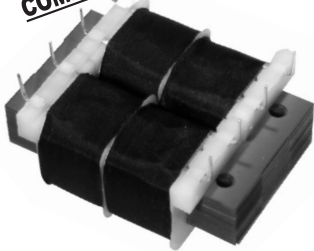

**AGENCY APPROVALS**

- UL, 506, File E73539
- UL 1446, File E179499
- CSA 22.2#66, File LR68051-2

- Ⓢ Semi-toroidal construction reduces EMI
- Ⓢ Low profile - Ideal for low height PC board applications
- Ⓢ 1500VRMS HIPOT
- Ⓢ Vacuum impregnated - withstands board washing systems and reduces audible noise
- Ⓢ Baked resin provides environmentally-resistant finish
- Ⓢ Sizes 2, 6 and 12 are available as encapsulated, hermetically sealed (request drawings)

Part Number	Size	Secondary RMS Rating	
		Series	Parallel
LP10-250B23	2	10V C.T. @ 250mA	5V @ 500mA
LP10-600B1	6	10V C.T. @ 600mA	5V @ 1.20A
LP10-1200B2	12	10V C.T. @ 1.20A	5V @ 2.40A
LP12-200B24	2	12.6V C.T. @ 200mA	6.3V @ 400mA
LP12-450B3	6	12.6V C.T. @ 450mA	6.3V @ 900mA
LP12-900B4	12	12.6V C.T. @ 900mA	6.3V @ 1.80A
LP16-150B25	2	16V C.T. @ 150mA	8V @ 300mA
LP16-350B5	6	16V C.T. @ 350mA	8V @ 700mA
LP16-700B6	12	16V C.T. @ 700mA	8V @ 1.40A
LP18-135B105	2	18V C.T. @ 135mA	9V @ 270mA
LP18-325B106	6	18V C.T. @ 325mA	9V @ 650mA
LP18-650B107	12	18V C.T. @ 650mA	9V @ 1.30A
LP20-125B26	2	20V C.T. @ 125mA	10V @ 250mA
LP20-300B7	6	20V C.T. @ 300mA	10V @ 600mA
LP20-600B8	12	20V C.T. @ 600mA	10V @ 1.20A
LP24-100B27	2	24V C.T. @ 100mA	12V @ 200mA
LP24-250B9	6	24V C.T. @ 250mA	12V @ 500mA
LP24-500B10	12	24V C.T. @ 500mA	12V @ 1.00A
LP28-90B115	2	28V C.T. @ 90mA	14V @ 180mA
LP28-215B116	6	28V C.T. @ 215mA	14V @ 430mA
LP28-430B117	12	28V C.T. @ 430mA	14V @ 860mA
LP30-85B125	2	30V C.T. @ 85mA	15V @ 170mA
LP30-200B126	6	30V C.T. @ 200mA	15V @ 400mA
LP30-400B127	12	30V C.T. @ 400mA	15V @ 800mA
LP34-75B28	2	34V C.T. @ 75mA	17V @ 150mA
LP34-170B11	6	34V C.T. @ 170mA	17V @ 340mA
LP34-340B12	12	34V C.T. @ 340mA	17V @ 680mA
LP40-60B29	2	40V C.T. @ 60mA	20V @ 120mA
LP40-150B13	6	40V C.T. @ 150mA	20V @ 300mA
LP40-300B14	12	40V C.T. @ 300mA	20V @ 600mA
LP56-45B30	2	56V C.T. @ 45mA	28V @ 90mA
LP56-100B15	6	56V C.T. @ 100mA	28V @ 200mA
LP56-200B16	12	56V C.T. @ 200mA	28V @ 400mA
LP88-28B31	2	88V C.T. @ 28mA	44V @ 56mA
LP88-65B17	6	88V C.T. @ 65mA	44V @ 130mA
LP88-130B18	12	88V C.T. @ 130mA	44V @ 260mA
LP120-20B32	2	120V C.T. @ 20mA	60V @ 40mA
LP120-50B19	6	120V C.T. @ 50mA	60V @ 100mA
LP120-100B20	12	120V C.T. @ 100mA	60V @ 200mA
LP230-10B33	2	230V C.T. @ 10mA	115V @ 20mA
LP230-25B21	6	230V C.T. @ 25mA	115V @ 50mA
LP230-50B22	12	230V C.T. @ 50mA	115V @ 100mA

## Mechanical

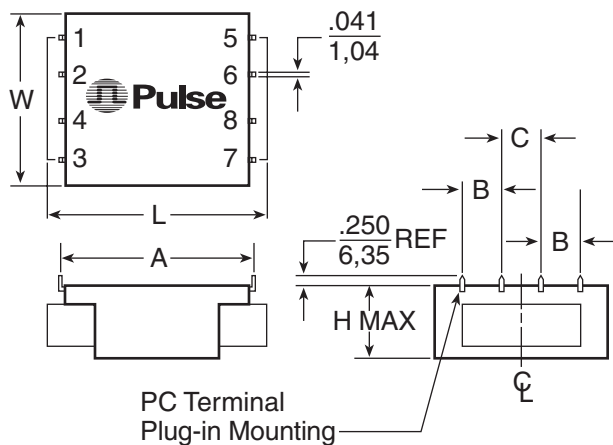

## Schematic

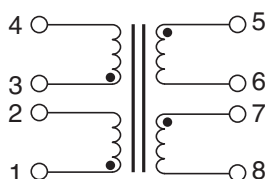

## Dimensions (inches)

Size	L	W	H	A	B	C	Wt. (oz.)	Reg. (% TYPE)	Trise (°C TYPE)
2	1.875	1.562	.650	1.600	.375	.375	5	20	25
6	1.875	1.562	.850	1.600	.375	.375	7	18	30
12	2.500	2.000	1.065	2.000	.500	.500	11	15	30

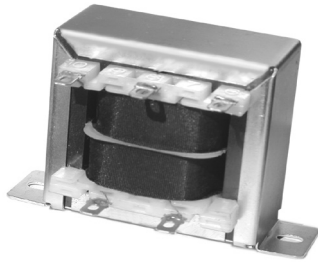

# Laminated Transformers

Low Frequency, Open-Style Laminated,  
Chassis-Tran Series



**AGENCY APPROVALS**

- UL, 506, File E73539
- UL 1446, File E179499
- CSA 22.2#66, File LR68051-2
- UL Recognized Class B

- Ⓜ Channel frame mounting
- Ⓜ Split bobbin. High isolation (2500V). 2500VRMS Hipot
- Ⓜ Non-concentric design - eliminates ESS
- Ⓜ No crossover between primary/secondary winding leads
- Ⓜ Vacuum impregnated - withstands board washing systems and reduces audible noise
- Ⓜ Baked resin provides environmentally-resistant finish
- Ⓜ Center tapped secondary offers dual outputs
- Ⓜ Terminals suitable for either hard wiring or quick connect

## Mechanicals

## Schematics

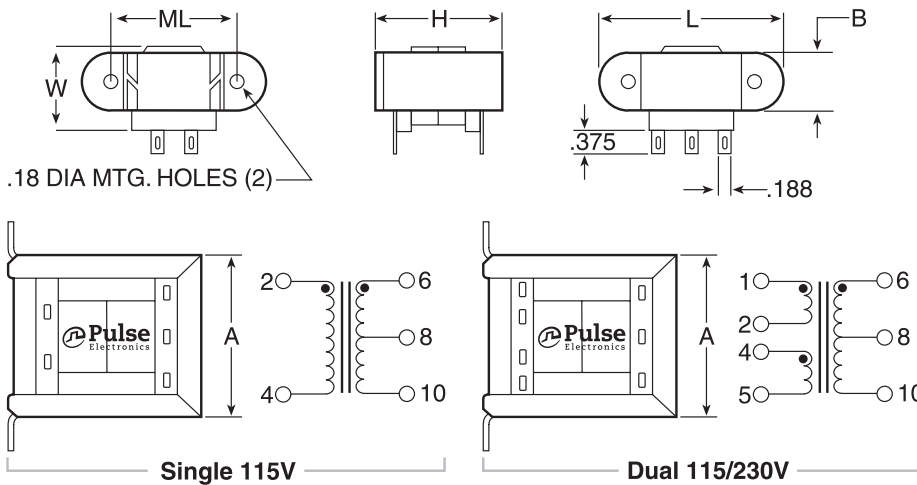

## Dimensions (inches)

Size	VA	L	W	H	A	B	ML	Wt. (lb.)
3	2.4	2.06	1.06	1.19	1.62	0.56	1.75	0.25
4	6	2.38	1.25	1.38	1.69	0.69	2.00	0.44
5	12	2.81	1.38	1.63	1.94	0.81	2.38	0.70
6	30	3.25	1.69	1.94	2.31	1.06	2.81	1.10
7	56	3.69	1.81	2.25	2.69	1.06	3.13	1.70
8	100	4.03	2.25	2.56	3.06	1.31	3.56	2.75

Part Number	Secondary RMS Rating	
	Single 115V	Dual 115/230V
241-3-10A1	(not available)	10V C.T. @ 0.25A
241-4-10A11	DP 241-4-10A11	10V C.T. @ 0.6A
241-5-10A21	DP 241-5-10A21	10V C.T. @ 1.2A
241-6-10A31	DP 241-6-10A31	10V C.T. @ 3.0A
241-7-10A41	DP 241-7-10A41	10V C.T. @ 5.0A
241-8-10A51	DP 241-8-10A51	10V C.T. @ 10A
241-3-12A2	(not available)	12.6V C.T. @ 0.2A
241-4-12A12	DP 241-4-12A12	12.6V C.T. @ 0.5A
241-5-12A22	DP 241-5-12A22	12.6V C.T. @ 1.0A
241-6-12A32	DP 241-6-12A32	12.6V C.T. @ 2.5A
241-7-12A42	DP 241-7-12A42	12.6V C.T. @ 4.0A
241-8-12A52	DP 241-8-12A52	12.6V C.T. @ 8.0A
241-3-16A3	(not available)	16V C.T. @ 0.15A
241-4-16A13	DP 241-4-16A13	16V C.T. @ 0.4A
241-5-16A23	DP 241-5-16A23	16V C.T. @ 0.8A
241-6-16A33	DP 241-6-16A33	16V C.T. @ 2.0A
241-7-16A43	DP 241-7-16A43	16V C.T. @ 3.5A
241-8-16A53	DP 241-8-16A53	16V C.T. @ 6.25A
241-3-20A4	(not available)	20V C.T. @ 0.12A
241-4-20A14	DP 241-4-20A14	20V C.T. @ 0.3A
241-5-20A24	DP 241-5-20A24	20V C.T. @ 0.6A
241-6-20A34	DP 241-6-20A34	20V C.T. @ 1.5A
241-7-20A44	DP 241-7-20A44	20V C.T. @ 2.8A
241-8-20A54	DP 241-8-20A54	20V C.T. @ 5.0A
241-3-24A5	(not available)	24V C.T. @ 0.1A
241-4-24A15	DP 241-4-24A15	24V C.T. @ 0.25A
241-5-24A25	DP 241-5-24A25	24V C.T. @ 0.5A
241-6-24A35	DP 241-6-24A35	24V C.T. @ 1.25A
241-7-24A45	DP 241-7-24A45	24V C.T. @ 2.4A
241-8-24A55	DP 241-8-24A55	24V C.T. @ 4.0A
241-3-28A6	(not available)	28V C.T. @ 0.085A
241-4-28A16	DP 241-4-28A16	28V C.T. @ 0.2A
241-5-28A26	DP 241-5-28A26	28V C.T. @ 0.42A
241-6-28A36	DP 241-6-28A36	28V C.T. @ 1.1A
241-7-28A46	DP 241-7-28A46	28V C.T. @ 2.0A
241-8-28A56	DP 241-8-28A56	28V C.T. @ 3.6A
241-3-36A7	(not available)	36V C.T. @ 0.065A
241-4-36A17	DP 241-4-36A17	36V C.T. @ 0.17A
241-5-36A27	DP 241-5-36A27	36V C.T. @ 0.35A
241-6-36A37	DP 241-6-36A37	36V C.T. @ 0.85A
241-7-36A47	DP 241-7-36A47	36V C.T. @ 1.5A
241-8-36A57	DP 241-8-36A57	36V C.T. @ 2.8A
241-3-48A8	(not available)	48V C.T. @ 0.05A
241-4-48A18	DP 241-4-48A18	48V C.T. @ 0.125A
241-5-48A28	DP 241-5-48A28	48V C.T. @ 0.25A
241-6-48A38	DP 241-6-48A38	48V C.T. @ 0.63A
241-7-48A48	DP 241-7-48A48	48V C.T. @ 1.2A
241-8-48A58	DP 241-8-48A58	48V C.T. @ 2.0A
241-3-56A9	(not available)	56V C.T. @ 0.045A
241-4-56A19	DP 241-4-56A19	56V C.T. @ 0.11A
241-5-56A29	DP 241-5-56A29	56V C.T. @ 0.22A
241-6-56A39	DP 241-6-56A39	56V C.T. @ 0.54A
241-7-56A49	DP 241-7-56A49	56V C.T. @ 1.0A
241-8-56A59	DP 241-8-56A59	56V C.T. @ 1.8A
241-3-120A10	(not available)	120V C.T. @ 0.02A
241-4-120A20	DP 241-4-120A20	120V C.T. @ 0.05A
241-5-120A30	DP 241-5-120A30	120V C.T. @ 0.1A
241-6-120A40	DP 241-6-120A40	120V C.T. @ 0.25A
241-7-120A50	DP 241-7-120A50	120V C.T. @ 0.5A
241-8-120A60	DP 241-8-120A60	120V C.T. @ 0.85A

# Laminated Transformers

Low Frequency, Open-Style Laminated,  
International PC Plug-In Series

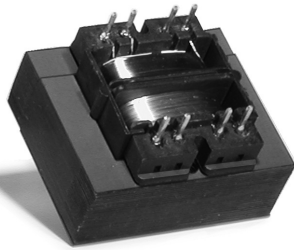

**AGENCY APPROVALS**

- UL, 506, File E73539
- UL Recognized Class B
- UL 1446, File E179499
- CSA 22.2#66, File LR68051-2
- TÜV, EN61558

- ⊕ PC board plug-in mounting
- ⊕ Double reinforced insulation
- ⊕ Dual bobbin; high (4000V) primary to secondary isolation
- ⊕ Non-concentric design - eliminates ESS and reduces primary to secondary capacitance
- ⊕ No crossover between primary/secondary leads
- ⊕ Vacuum impregnated - withstands board washing systems and reduces audible noise
- ⊕ Baked resin provides an environmentally-resistant finish

Part No. PC Mount	VA (Size)	Secondary RMS Rating	
		Series	Parallel
14A-2.5-10B1	2.5	10V C.T. @ 0.25A	5V @ 0.5A
14A-5.0-10B2	5	10V C.T. @ 0.5A	5V @ 1.0A
14A-10-10B3	10	10V C.T. @ 1.0A	5V @ 2.0A
14A-20-10B4	20	10V C.T. @ 2.0A	5V @ 4.0A
14A-30-10B5	30	10V C.T. @ 3.0A	5V @ 6.0A
14A-56-10B6	56	10V C.T. @ 5.6A	5V @ 11.2A
14A-2.5-12B7	2.5	12.6V C.T. @ 0.2A	6.3V @ 0.4A
14A-5.0-12B8	5	12.6V C.T. @ 0.4A	6.3V @ 0.8A
14A-10-12B9	10	12.6V C.T. @ 0.8A	6.3V @ 1.6A
14A-20-12B10	20	12.6V C.T. @ 1.6A	6.3V @ 3.2A
14A-30-12B11	30	12.6V C.T. @ 2.4A	6.3V @ 4.8A
14A-56-12B12	56	12.6V C.T. @ 4.4A	6.3V @ 8.8A
14A-2.5-16B13	2.5	16V C.T. @ 0.15A	8V @ 0.3A
14A-5.0-16B14	5	16V C.T. @ 0.31A	8V @ 0.62A
14A-10-16B15	10	16V C.T. @ 0.62A	8V @ 1.25A
14A-20-16B16	20	16V C.T. @ 1.25A	8V @ 2.5A
14A-30-16B17	30	16V C.T. @ 1.9A	8V @ 3.8A
14A-56-16B18	56	16V C.T. @ 3.5A	8V @ 7.0A
14A-2.5-20B19	2.5	20V C.T. @ 0.12A	10V @ 0.24A
14A-5.0-20B20	5	20V C.T. @ 0.25A	10V @ 0.5A
14A-10-20B21	10	20V C.T. @ 0.5A	10V @ 1.0A
14A-20-20B22	20	20V C.T. @ 1.0A	10V @ 2.0A
14A-30-20B23	30	20V C.T. @ 1.5A	10V @ 3.0A
14A-56-20B24	56	20V C.T. @ 2.8A	10V @ 5.6A
14A-2.5-24B25	2.5	24V C.T. @ 0.1A	12V @ 0.2A
14A-5.0-24B26	5	24V C.T. @ 0.21A	12V @ 0.42A
14A-10-24B27	10	24V C.T. @ 0.42A	12V @ 0.84A
14A-20-24B28	20	24V C.T. @ 0.83A	12V @ 1.66A
14A-30-24B29	30	24V C.T. @ 1.25A	12V @ 2.5A
14A-56-24B30	56	24V C.T. @ 2.33A	12V @ 4.66A
14A-2.5-28B31	2.5	28V C.T. @ 0.09A	14V @ 0.18A
14A-5.0-28B32	5	28V C.T. @ 0.18A	14V @ 0.36A
14A-10-28B33	10	28V C.T. @ 0.36A	14V @ 0.72A
14A-20-28B34	20	28V C.T. @ 0.72A	14V @ 1.44A
14A-30-28B35	30	28V C.T. @ 1.06A	14V @ 2.12A
14A-56-28B36	56	28V C.T. @ 2.0A	14V @ 4.0A
14A-2.5-36B37	2.5	36V C.T. @ 0.07A	18V @ 0.14A
14A-5.0-36B38	5	36V C.T. @ 0.14A	18V @ 0.28A
14A-10-36B39	10	36V C.T. @ 0.28A	18V @ 0.56A
14A-20-36B40	20	36V C.T. @ 0.56A	18V @ 1.12A
14A-30-36B41	30	36V C.T. @ 0.82A	18V @ 1.64A
14A-56-36B42	56	36V C.T. @ 1.56A	18V @ 3.12A

## Mechanical

## Schematic

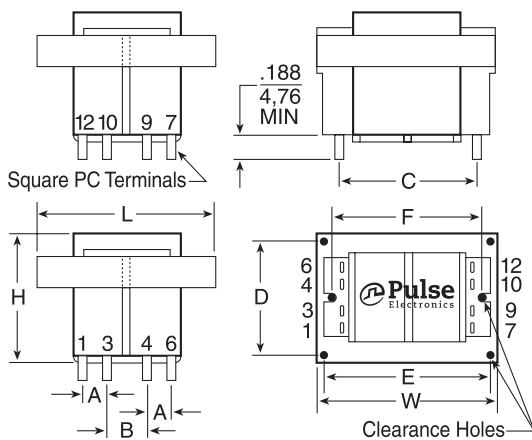

## Dimensions (inches)

VA (size)	Wt. (lb.)	L	W	H	A	B	C	D	E	F	Pin Dim.	E
2.5	0.25	1.625	1.312	1.125	0.20	0.250	1.00	—	—	1.062	.025 SQ	#4
5	0.37	1.625	1.312	1.375	0.20	0.400	1.00	—	—	1.062	.025 SQ	#4
10	0.53	1.875	1.562	1.375	0.20	0.400	1.14	—	—	1.250	.038 SQ	#4
20	0.90	2.25	1.875	1.625	0.40	0.400	1.46	—	—	1.500	.038 SQ	#4
30	1.15	2.625	2.187	1.562	0.55	0.275	1.68	2.18	1.75	—	.045 SQ	#6
56	1.70	3.000	2.500	1.812	0.60	0.300	1.90	2.50	2.00	—	.045 SQ	#6

# Laminated Transformers

Low Frequency, Open-Style Laminated,  
International High Power Series

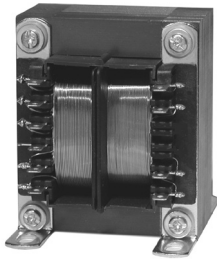

**AGENCY APPROVALS**

- UL, 506, File E73539
- UL Recognized Class B
- UL 1446, File E179499
- CSA 22.2#66, File LR68051-2
- TÜV, EN61558

- ⚙ Chassis mounting
- ⚙ Dual bobbin; double reinforced insulation
- ⚙ High (4000V) primary to secondary isolation
- ⚙ Non-concentric design - eliminates ESS and reduces primary to secondary capacitance
- ⚙ No crossover between primary/secondary leads
- ⚙ Baked resin provides environmentally-resistant finish

## Mechanical

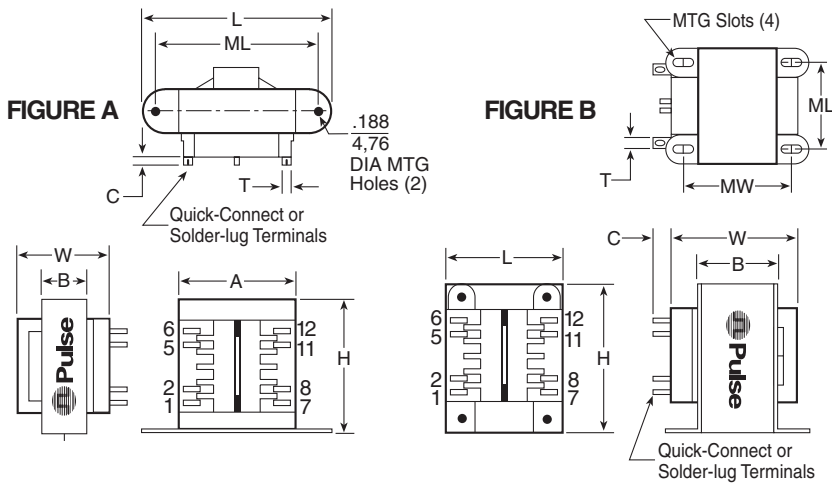

## Schematic

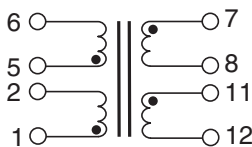

## Dimensions (inches)

VA (size)	Wt. (lb.)	L	W	H	A	B	C	T	ML	MW	MTG.	FIG.
25	1.25	2.812	1.875	2.312	2.00	1.125	0.330	0.187	2.375	—	#6	A
43	1.60	3.125	2.062	2.687	2.25	1.125	0.312	0.187	2.812	—	#6	A
80	2.80	2.500	2.375	3.050	—	1.375	0.330	0.187	2.000	2.180	#6	B
130	4.10	2.812	2.875	3.380	—	1.625	0.395	0.187	2.250	2.500	#8	B
175	5.50	3.125	2.875	3.750	—	1.625	0.395	0.187	2.500	2.500	#8	B

Part No. Chassis Mount	VA (Size)	Secondary RMS Rating	
		Series	Parallel
A41-25-10A1	25	10V C.T. @ 2.5A	5V @ 5.0A
A41-43-10A2	43	10V C.T. @ 4.3A	5V @ 8.6A
A41-80-10A3	80	10V C.T. @ 8.0A	5V @ 16.0A
A41-130-10A4	130	10V C.T. @ 13.0A	5V @ 26.0A
A41-175-10A5	175	10V C.T. @ 17.5A	5V @ 35.0A
A41-25-12A7	25	12.6V C.T. @ 2.0A	6.3V @ 4.0A
A41-43-12A8	43	12.6V C.T. @ 3.4A	6.3V @ 6.8A
A41-80-12A9	80	12.6V C.T. @ 6.3A	6.3V @ 12.6A
A41-130-12A10	130	12.6V C.T. @ 10.3A	6.3V @ 20.6A
A41-175-12A11	175	12.6V C.T. @ 14.0A	6.3V @ 28.0A
A41-25-16A13	25	16V C.T. @ 1.6A	8V @ 3.2A
A41-43-16A14	43	16V C.T. @ 2.7A	8V @ 5.4A
A41-80-16A15	80	16V C.T. @ 5.0A	8V @ 10.0A
A41-130-16A16	130	16V C.T. @ 8.1A	8V @ 16.2A
A41-175-16A17	175	16V C.T. @ 11.0A	8V @ 22.0A
A41-25-20A19	25	20V C.T. @ 1.25A	10V @ 2.5A
A41-43-20A20	43	20V C.T. @ 2.2A	10V @ 4.4A
A41-80-20A21	80	20V C.T. @ 4.0A	10V @ 8.0A
A41-130-20A22	130	20V C.T. @ 6.5A	10V @ 13.0A
A41-175-20A23	175	20V C.T. @ 8.8A	10V @ 17.6A
A41-25-24A25	25	24V C.T. @ 1A	12V @ 2A
A41-43-24A26	43	24V C.T. @ 1.8A	12V @ 3.6A
A41-80-24A27	80	24V C.T. @ 3.3A	12V @ 6.6A
A41-130-24A28	130	24V C.T. @ 5.4A	12V @ 10.8A
A41-175-24A29	175	24V C.T. @ 7.3A	12V @ 14.6A
A41-25-28A31	25	28V C.T. @ 0.9A	14V @ 1.86A
A41-43-28A32	43	28V C.T. @ 1.5A	14V @ 3.0A
A41-80-28A33	80	28V C.T. @ 2.8A	14V @ 5.6A
A41-130-28A34	130	28V C.T. @ 4.6A	14V @ 9.2A
A41-175-28A35	175	28V C.T. @ 6.25A	14V @ 12.5A
A41-25-36A37	25	36V C.T. @ 0.7A	18V @ 1.4A
A41-43-36A38	43	36V C.T. @ 1.2A	18V @ 2.4A
A41-80-36A39	80	36V C.T. @ 2.2A	18V @ 4.4A
A41-130-36A40	130	36V C.T. @ 3.6A	18V @ 7.2A
A41-175-36A41	175	36V C.T. @ 4.8A	18V @ 9.6A
A41-25-230A42	25	230V C.T. @ 0.11A	115V @ 0.22A
A41-43-230A43	43	230V C.T. @ 0.19A	115V @ 0.38A
A41-80-230A44	80	230V C.T. @ 0.35A	115V @ 0.7A
A41-130-230A45	130	230V C.T. @ 0.57A	115V @ 1.14A
A41-175-230A46	175	230V C.T. @ 0.76A	115V @ 1.52A



# Laminated Transformers

Low Frequency, Open-Style Laminated,  
Split Bobbin, Horizontal Plug-In Series

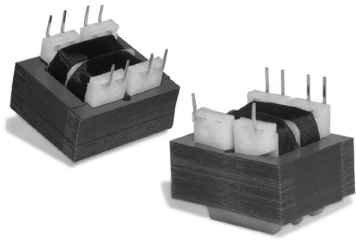

**AGENCY APPROVALS**

- UL 506, File E73539
- UL 1446, File E179499
- UL 1585, File E169010  
Class 2 Component Recognition
- CSA 22.2#66,  
File LR68051-2
- UL Recognized Class B

- High (2500V) isolation; 2500VRMS HIPOT
- Non-concentric design - eliminates ESS
- No crossover between primary/secondary winding leads
- Vacuum impregnated - withstands board washing systems and reduces audible noise
- Baked resin provides an environmentally-resistant finish
- Rugged construction - no additional mounting hardware
- Universal design, fits industry-standard footprints
- Available in single or dual primary

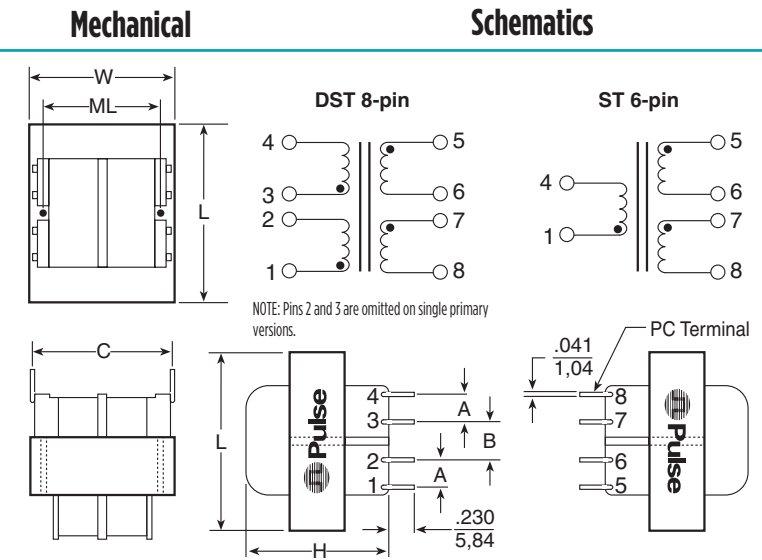

## Dimensions (inches)

Size	VA	L	W	H	A	B	C	ML	Wt. (lb.)
2	1.1	1.38	1.13	0.94	0.25	0.25	1.20	----	0.17
3	2.4	1.38	1.13	1.19	0.25	0.25	1.20	----	0.25
4	6.0	1.63	1.31	1.31	0.25	0.35	1.28	1.06	0.44
5	12	1.88	1.56	1.44	0.30	0.40	1.41	1.25	0.70
6	20	2.25	1.88	1.44	0.30	0.40	1.60	1.50	0.80
7*	36	2.63	2.19	1.56	0.40	0.40	1.80	----	1.10

\*Size 7 has 4 MTG. holes on 2.188" x 1.75" centers.

Part No. 115V-6Pin	Part No. 115/230V-8Pin	Secondary RMS Rating	
		Series	Parallel
ST2-10B41 <sup>1</sup>	DST2-10B41 <sup>1</sup>	10V C.T. @ 0.11A	5V @ 0.22A
ST3-10B1 <sup>1</sup>	DST3-10B1 <sup>1</sup>	10V C.T. @ 0.25A	5V @ 0.5A
ST4-10B2	DST4-10B2	10V C.T. @ 0.6A	5V @ 1.2A
ST5-10B3	DST5-10B3	10V C.T. @ 1.2A	5V @ 2.4A
ST6-10B4	DST6-10B4	10V C.T. @ 2A	5V @ 4A
ST7-10B51	DST7-10B51	10V C.T. @ 5.6A	5V @ 7.2A
ST2-12B42 <sup>1</sup>	DST2-12B42 <sup>1</sup>	12.6V C.T. @ 0.09A	6.3V @ 0.18A
ST3-12B5 <sup>1</sup>	DST3-12B5 <sup>1</sup>	12.6V C.T. @ 0.2A	6.3V @ 0.4A
ST4-12B6	DST4-12B6	12.6V C.T. @ 0.5A	6.3V @ 1.0A
ST5-12B7	DST5-12B7	12.6V C.T. @ 1.0A	6.3V @ 2.0A
ST6-12B8	DST6-12B8	12.6V C.T. @ 1.6A	6.3V @ 3.2A
ST7-12B52	DST7-12B52	12.6V C.T. @ 2.85A	6.3V @ 5.7A
ST2-16B43 <sup>1</sup>	DST2-16B43 <sup>1</sup>	16V C.T. @ 0.07A	8V @ 0.14A
ST3-16B9 <sup>1</sup>	DST3-16B9 <sup>1</sup>	16V C.T. @ 0.15A	8V @ 0.3A
ST4-16B10	DST4-16B10	16V C.T. @ 0.4A	8V @ 0.8A
ST5-16B11	DST5-16B11	16V C.T. @ 0.8A	8V @ 1.6A
ST6-16B12	DST6-16B12	16V C.T. @ 1.25A	8V @ 2.5A
ST7-16B53	DST7-16B53	16V C.T. @ 2.25A	8V @ 4.5A
ST2-20B44 <sup>1</sup>	DST2-20B44 <sup>1</sup>	20V C.T. @ 0.055A	10V @ 0.11A
ST3-20B13 <sup>1</sup>	DST3-20B13 <sup>1</sup>	20V C.T. @ 0.12A	10V @ 0.24A
ST4-20B14	DST4-20B14	20V C.T. @ 0.3A	10V @ 0.6A
ST5-20B15	DST5-20B15	20V C.T. @ 0.6A	10V @ 1.2A
ST6-20B16	DST6-20B16	20V C.T. @ 1A	10V @ 2A
ST7-20B54	DST7-20B54	20V C.T. @ 1.8A	10V @ 3.6A
ST2-24B45 <sup>1</sup>	DST2-24B45 <sup>1</sup>	24V C.T. @ 0.045A	12V @ 0.09A
ST3-24B17 <sup>1</sup>	DST3-24B17 <sup>1</sup>	24V C.T. @ 0.1A	12V @ 0.2A
ST4-24B18	DST4-24B18	24V C.T. @ 0.25A	12V @ 0.5A
ST5-24B19	DST5-24B19	24V C.T. @ 0.5A	12V @ 1.0A
ST6-24B20	DST6-24B20	24V C.T. @ 0.8A	12V @ 1.6A
ST7-24B55	DST7-24B55	24V C.T. @ 1.5A	12V @ 3.0A
ST2-28B46	DST2-28B46	28V C.T. @ 0.04A	14V @ 0.08A
ST3-28B21	DST3-28B21	28V C.T. @ 0.085A	14V @ 0.17A
ST4-28B22	DST4-28B22	28V C.T. @ 0.2A	14V @ 0.4A
ST5-28B23	DST5-28B23	28V C.T. @ 0.42A	14V @ 0.84A
ST6-28B24	DST6-28B24	28V C.T. @ 0.7A	14V @ 1.4A
ST7-28B56	DST7-28B56	28V C.T. @ 1.3A	14V @ 2.6A
ST2-36B47	DST2-36B47	36V C.T. @ 0.03A	18V @ 0.06A
ST3-36B25	DST3-36B25	36V C.T. @ 0.065A	18V @ 0.13A
ST4-36B26	DST4-36B26	36V C.T. @ 0.17A	18V @ 0.34A
ST5-36B27	DST5-36B27	36V C.T. @ 0.35A	18V @ 0.7A
ST6-36B28	DST6-36B28	36V C.T. @ 0.55A	18V @ 1.1A
ST7-36B57	DST7-36B57	36V C.T. @ 1.0A	18V @ 2.0A
ST2-48B48	DST2-48B48	48V C.T. @ 0.023A	24V @ 0.046A
ST3-48B29	DST3-48B29	48V C.T. @ 0.05A	24V @ 0.1A
ST4-48B30	DST4-48B30	48V C.T. @ 0.125A	24V @ 0.25A
ST5-48B31	DST5-48B31	48V C.T. @ 0.25A	24V @ 0.5A
ST6-48B32	DST6-48B32	48V C.T. @ 0.4A	24V @ 0.8A
ST7-48B58	DST7-48B58	48V C.T. @ 0.75A	24V @ 1.5A
ST2-56B49	DST2-56B49	56V C.T. @ 0.02A	28V @ 0.04A
ST3-56B33	DST3-56B33	56V C.T. @ 0.045A	28V @ 0.09A
ST4-56B34	DST4-56B34	56V C.T. @ 0.11A	28V @ 0.22A
ST5-56B35	DST5-56B35	56V C.T. @ 0.22A	28V @ 0.44A
ST6-56B36	DST6-56B36	56V C.T. @ 0.35A	28V @ 0.7A
ST7-56B59	DST7-56B59	56V C.T. @ 0.65A	28V @ 1.3A
ST2-120B50	DST2-120B50	120V C.T. @ 0.01A	60V @ 0.02A
ST3-120B37	DST3-120B37	120V C.T. @ 0.02A	60V @ 0.04A
ST4-120B38	DST4-120B38	120V C.T. @ 0.05A	60V @ 0.1A
ST5-120B39	DST5-120B39	120V C.T. @ 0.1A	60V @ 0.2A
ST6-120B40	DST6-120B40	120V C.T. @ 0.16A	60V @ 0.32A
ST7-120B60	DST7-120B60	120V C.T. @ 0.3A	60V @ 0.6A

<sup>1</sup>UL 1585 approved, Class 2 - Not Wet, Class 3 - Wet

# Laminated Transformers

Low Frequency, Open-Style Laminated, Concentric Vertical Profile, PC Plug-In

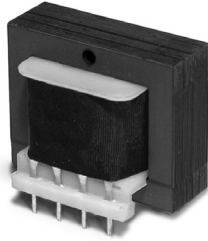

**AGENCY APPROVALS**

- UL, 506, File E73539
- UL Recognized Class B
- UL 1446, File E179499
- CSA 22.2#66, File LR68051-2

- PC Series Concentric Vertical Mount**  
Isolation between primary and secondary of 1500V.
- Vacuum Impregnated** to withstand modern board washing systems and to reduce audible noise.
- Available in single or dual primary**
- Baked Resin** provides fully cured and environmentally resistant finish that will not peel or flake.
- Rugged Construction**
- Universal Design** compatible with industry-standard footprints

Single 115V 6-Pin	Dual 115/230V 8-Pin	Size	Series V.C.T. @mA	Parallel @ 2x Current V. @mA
PC-10-90B53	DPC-10-90B53	25	10 @ 90	5 @ 180
PC-10-120B1	DPC-10-120B1	37	10 @ 120	5 @ 240
PC-10-440B2	DPC-10-440B2	50	10 @ 440	5 @ 880
PC-10-1000B3	DPC-10-1000B3	62	10 @ 1000	5 @ 2000
PC-10-2400B4	DPC-10-2400B4	24	10 @ 2400	5 @ 4800
PC-12-70B54	DPC-12-70B54	25	12.6 @ 70	6.3 @ 140
PC-12-100B5	DPC-12-100B5	37	12.6 @ 100	6.3 @ 200
PC-12-350B6	DPC-12-350B6	50	12.6 @ 350	6.3 @ 700
PC-12-800B7	DPC-12-800B7	62	12.6 @ 800	6.3 @ 1600
PC-12-2000B8	DPC-12-2000B8	24	12.6 @ 2000	6.3 @ 4000
PC-16-55B55	DPC-16-55B55	25	16 @ 55	8 @ 110
PC-16-75B9	DPC-16-75B9	37	16 @ 75	8 @ 150
PC-16-260B10	DPC-16-260B10	50	16 @ 260	8 @ 520
PC-16-640B11	DPC-16-640B11	62	16 @ 640	8 @ 1280
PC-16-1500B12	DPC-16-1500B12	24	16 @ 1500	8 @ 3000
PC-20-45B56	DPC-20-45B56	25	20 @ 45	10 @ 90
PC-20-60B13	DPC-20-60B13	37	20 @ 60	10 @ 120
PC-20-220B14	DPC-20-220B14	50	20 @ 220	10 @ 440
PC-20-500B15	DPC-20-500B15	62	20 @ 500	10 @ 1000
PC-20-1200B16	DPC-20-1200B16	24	20 @ 1200	10 @ 2400
PC-24-35B57	DPC-24-35B57	25	24 @ 35	12 @ 70
PC-24-50B17	DPC-24-50B17	37	24 @ 50	12 @ 100
PC-24-180B18	DPC-24-180B18	50	24 @ 180	12 @ 360
PC-24-450B19	DPC-24-450B19	62	24 @ 450	12 @ 900
PC-24-1000B20	DPC-24-1000B20	24	24 @ 1000	12 @ 2000
PC-28-30B58	DPC-28-30B58	25	28 @ 30	14 @ 60
PC-28-40B49	DPC-28-40B49	37	28 @ 40	14 @ 80
PC-28-160B50	DPC-28-160B50	50	28 @ 160	14 @ 320
PC-28-360B51	DPC-28-360B51	62	28 @ 360	14 @ 720
PC-28-800B52	DPC-28-800B52	24	28 @ 800	14 @ 1600
PC-34-25B59	DPC-34-25B59	25	34 @ 25	17 @ 50
PC-34-35B21	DPC-34-35B21	37	34 @ 35	17 @ 70
PC-34-125B22	DPC-34-125B22	50	34 @ 125	17 @ 250
PC-34-300B23	DPC-34-300B23	62	34 @ 300	17 @ 600
PC-34-700B24	DPC-34-700B24	24	34 @ 700	17 @ 1400
PC-40-20B60	DPC-40-20B60	25	40 @ 20	20 @ 40
PC-40-30B25	DPC-40-30B25	37	40 @ 30	20 @ 60
PC-40-110B26	DPC-40-110B26	50	40 @ 110	20 @ 220
PC-40-250B27	DPC-40-250B27	62	40 @ 250	20 @ 500
PC-40-600B28	DPC-40-600B28	24	40 @ 600	20 @ 1200
PC-56-15B61	DPC-56-15B61	25	56 @ 15	28 @ 30
PC-56-20B29	DPC-56-20B29	37	56 @ 20	28 @ 40
PC-56-80B30	DPC-56-80B30	50	56 @ 80	28 @ 160
PC-56-180B31	DPC-56-180B31	62	56 @ 180	28 @ 360
PC-56-420B32	DPC-56-420B32	24	56 @ 420	28 @ 840
PC-120-8B63	DPC-120-8B63	25	120 @ 8	60 @ 16
PC-120-10B37	DPC-120-10B37	37	120 @ 10	60 @ 20
PC-120-35B38	DPC-120-35B38	50	120 @ 35	60 @ 70
PC-120-85B39	DPC-120-85B39	62	120 @ 85	60 @ 170
PC-120-200B40	DPC-120-200B40	24	120 @ 200	60 @ 400
PC-230-4B65	DPC-230-4B65	25	230 @ 4	115 @ 8
PC-230-5B45	DPC-230-5B45	37	230 @ 5	115 @ 10
PC-230-20B46	DPC-230-20B46	50	230 @ 20	115 @ 40
PC-230-40B47	DPC-230-40B47	62	230 @ 40	115 @ 80
PC-230-100B48	DPC-230-100B48	24	230 @ 100	115 @ 200

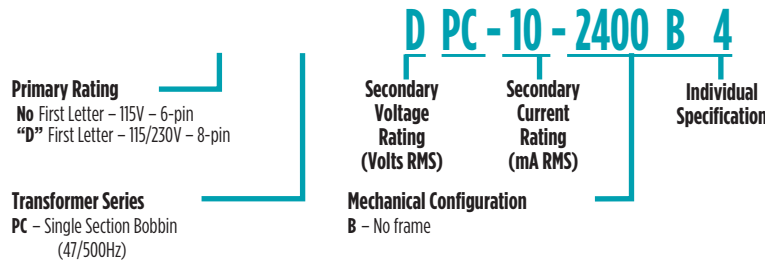

## Dimensions (inches)

Size	VA	Wt. (oz.)	L	H	W	B	6-pin X	8-pin A
25	1.0	2.5	1.000	0.830	1.375	1.200	0.250	0.200
37	1.2	3	1.375	1.188	1.125	1.000	0.312	0.200
50	4.4	5	1.625	1.375	1.250	1.100	0.400	0.250
62	10	9	1.875	1.625	1.438	1.300	0.400	0.250
24	24	12	1.625	1.375	2.250	2.100	0.400	0.250

## Mechanical

Dimensions for Style B (no frame) are shown.

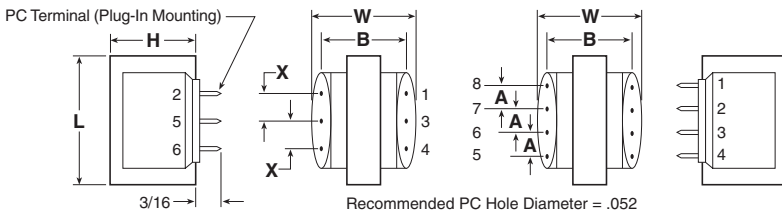

## Schematics

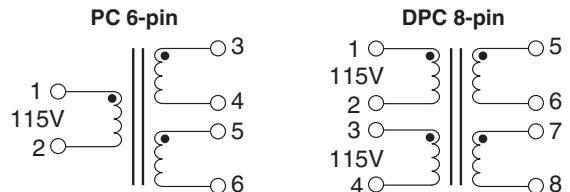



## PARTS INDEX

Part No.	Page	Part No.	Page	Part No.	Page	Part No.	Page	Part No.	Page	Part No.	Page	Part No.	Page
14A-10-10B3	40	241-5-56A29	4	DP 241-4-10A11	4	DPC-20-220B14	8	DST5-36B27	7	PC-120-200B40	8	ST4-12B6	7
14A-10-12B9	40	241-6-10A31	4	DP 241-4-120A20	4	DPC-20-45B56	8	DST5-48B31	7	PC-120-35B58	8	ST4-16B10	7
14A-10-16B15	40	241-6-120A40	4	DP 241-4-12A12	4	DPC-20-500B15	8	DST5-56B35	8	PC-120-85B39	8	ST4-20B14	7
14A-10-20B21	40	241-6-12A32	4	DP 241-4-16A13	4	DPC-20-60B13	8	DST6-10B4	7	PC-120-88B63	8	ST4-24B18	7
14A-10-24B27	40	241-6-16A33	4	DP 241-4-20A14	4	DPC-230-100B48	8	DST6-120B40	7	PC-12-100B5	8	ST4-28B22	7
14A-10-28B33	40	241-6-20A34	4	DP 241-4-24A15	4	DPC-230-20B46	8	DST6-12B8	7	PC-12-200B8	8	ST4-36B26	7
14A-10-36B39	40	241-6-24A35	4	DP 241-4-28A16	4	DPC-230-40B47	8	DST6-16B12	7	PC-12-350B6	8	ST4-48B30	7
14A-2.5-10B1	40	241-6-28A36	4	DP 241-4-36A17	4	DPC-230-48B5	8	DST6-20B16	7	PC-12-70B54	8	ST4-56B34	7
14A-2.5-12B7	40	241-6-36A37	4	DP 241-4-48A18	4	DPC-230-58A5	8	DST6-24B20	7	PC-12-800B7	8	ST5-10B3	7
14A-2.5-16B13	40	241-6-48A38	4	DP 241-4-56A19	4	DPC-24-1000B20	8	DST6-28B24	7	PC-16-1500B12	8	ST5-120B39	7
14A-2.5-20B19	40	241-6-56A39	4	DP 241-5-10A21	4	DPC-24-180B18	8	DST6-36B28	7	PC-16-260B10	8	ST5-12B7	7
14A-2.5-24B25	40	241-7-10A41	4	DP 241-5-120A30	4	DPC-24-35B57	8	DST6-48B32	7	PC-16-55B55	8	ST5-16B11	7
14A-2.5-28B31	40	241-7-120A50	4	DP 241-5-12A22	4	DPC-24-450B19	8	DST6-56B36	7	PC-16-640B11	8	ST5-20B15	7
14A-2.5-36B37	40	241-7-12A42	4	DP 241-5-16A23	4	DP 241-5-16A23	8	DST7-10B51	7	PC-16-75B9	8	ST5-24B19	7
14A-20-10B4	40	241-7-16A43	4	DP 241-5-20A24	4	DPC-28-160B50	8	DST7-120B60	7	PC-20-1200B16	8	ST5-28B23	7
14A-20-12B10	40	241-7-20A44	4	DP 241-5-24A25	4	DPC-28-30B58	8	DST7-12B52	7	PC-20-220B14	8	ST5-36B27	7
14A-20-16B16	40	241-7-24A45	4	DP 241-5-28A26	4	DPC-28-360B51	8	DST7-16B53	7	PC-20-45B56	8	ST5-48B31	7
14A-20-20B22	40	241-7-28A46	4	DP 241-5-36A27	4	DPC-28-40B49	8	DST7-20B54	7	PC-20-500B15	8	ST5-56B35	7
14A-20-24B28	40	241-7-36A47	4	DP 241-5-48A28	4	DPC-28-800B52	8	DST7-24B55	7	PC-20-60B13	8	ST6-10B4	7
14A-20-28B34	40	241-7-48A48	4	DP 241-5-56A29	4	DP 241-5-56A29	8	DST7-28B56	7	DST7-28B56	8	ST6-120B40	7
14A-20-36B40	40	241-7-56A49	4	DP 241-6-10A31	4	DPC-34-25B59	8	DST7-36B57	7	PC-230-20B46	8	ST6-12B8	7
14A-30-10B5	40	241-8-10A51	4	DP 241-6-120A40	4	DPC-34-300B23	8	DST7-48B58	7	PC-230-40B47	8	ST6-16B12	7
14A-30-12B11	40	241-8-120A60	4	DP 241-6-12A32	4	DP 241-6-12A32	8	DST7-56B59	7	PC-230-48B65	8	ST6-20B16	7
14A-30-16B17	40	241-8-12A52	4	DP 241-6-16A33	4	DPC-34-700B24	8	LP10-1200B2	3	PC-230-58A5	8	ST6-24B20	7
14A-30-20B23	40	241-8-16A53	4	DP 241-6-20A34	4	DPC-40-110B26	8	LP10-250B23	3	PC-24-1000B20	8	ST6-28B24	7
14A-30-24B29	40	241-8-20A54	4	DP 241-6-24A35	4	DPC-40-200B6	8	LP10-600B1	3	PC-24-180B18	8	ST6-36B28	7
14A-30-28B35	40	241-8-24A55	4	DP 241-6-28A36	4	DPC-40-250B27	8	LP120-100B20	3	PC-24-35B57	8	ST6-48B32	7
14A-30-36B41	40	241-8-28A56	4	DP 241-6-36A37	4	DPC-40-30B25	8	LP120-20B32	3	PC-24-450B19	8	ST6-56B36	7
14A-5.0-10B2	40	241-8-36A57	4	DP 241-6-48A38	4	DPC-40-600B28	8	LP120-50B19	3	PC-24-50B17	8	ST7-10B51	7
14A-5.0-12B8	40	241-8-48A58	4	DP 241-6-56A39	4	DPC-56-15B61	8	LP12-200B24	3	PC-28-160B50	8	ST7-120B60	7
14A-5.0-16B14	40	241-8-56A59	4	DP 241-7-10A41	4	DPC-56-180B31	8	LP12-450B3	3	PC-28-30B58	8	ST7-12B52	7
14A-5.0-20B20	40	A41-130-10A4	6	DP 241-7-120A50	4	DPC-56-20B29	8	LP12-900B4	3	PC-28-360B51	8	ST7-16B53	7
14A-5.0-24B26	40	A41-130-12A10	6	DP 241-7-12A42	4	DPC-56-420B32	8	LP16-150B25	3	PC-28-40B49	8	ST7-20B54	7
14A-5.0-28B32	40	A41-130-16A16	6	DP 241-7-16A43	4	DPC-56-80B30	8	LP16-350B5	3	PC-28-800B52	8	ST7-24B55	7
14A-5.0-36B38	40	A41-130-20A22	6	DP 241-7-20A44	4	DST2-10B41	7	LP16-700B6	3	PC-34-125B22	8	ST7-28B56	7
14A-56-10B6	40	A41-130-230A45	6	DP 241-7-24A45	4	DST2-120B50	7	LP18-135B105	3	PC-34-25B59	8	ST7-36B57	7
14A-56-12B12	40	A41-130-24A28	6	DP 241-7-28A46	4	DST2-12B42	7	LP18-325B106	3	PC-34-300B23	8	ST7-48B58	7
14A-56-16B18	40	A41-130-28A34	6	DP 241-7-36A47	4	DST2-16B43	7	LP18-650B107	3	PC-34-35B21	8	ST7-56B59	7
14A-56-20B24	40	A41-130-36A40	6	DP 241-7-48A48	4	DST2-20B44	7	LP20-125B26	3	PC-34-700B24	8		
14A-56-24B30	40	A41-175-10A5	6	DP 241-7-56A49	4	DST2-24B45	7	LP20-300B7	3	PC-40-110B26	8		
14A-56-28B36	40	A41-175-12A11	6	DP 241-8-10A51	4	DST2-28B46	7	LP20-600B8	3	PC-40-20B60	8		
14A-56-36B42	40	A41-175-16A17	6	DP 241-8-120A60	4	DST2-36B47	7	LP230-10B33	3	PC-40-250B27	8		
241-3-10A1	39	A41-175-20A25	6	DP 241-8-12A52	4	DST2-48B48	7	LP230-25B21	3	PC-40-30B25	8		
241-3-120A10	39	A41-175-230A46	6	DP 241-8-16A53	4	DST2-56B49	7	LP230-50B22	3	PC-40-600B28	8		
241-3-12A2	39	A41-175-24A29	6	DP 241-8-20A54	4	DST2-56B49	7	LP24-100B27	3	PC-40-600B28	8		
241-3-16A3	39	A41-175-28A35	6	DP 241-8-24A55	4	DST3-10B1	7	LP24-250B9	3	PC-56-15B61	8		
241-3-20A4	39	A41-175-36A41	6	DP 241-8-28A56	4	DST3-120B37	7	LP24-500B10	3	PC-56-180B31	8		
241-3-24A5	39	A41-25-10A1	6	DP 241-8-36A57	4	DST3-12B5	7	LP28-215B116	3	PC-56-20B29	8		
241-3-28A6	39	A41-25-12A7	6	DP 241-8-48A58	4	DST3-16B9	7	LP28-430B117	3	PC-56-420B32	8		
241-3-36A7	39	A41-25-16A13	6	DP 241-8-56A59	4	DST3-20B13	7	LP28-90B15	3	PC-56-80B30	8		
241-3-48A8	39	A41-25-20A19	6	DPC-10-1000B3	8	DST3-24B17	7	LP30-200B126	3	ST2-10B41	7		
241-3-56A9	39	A41-25-230A42	6	DPC-10-120B1	8	DST3-28B21	7	LP30-400B127	3	ST2-120B50	7		
241-4-10A11	39	A41-25-24A25	6	DPC-10-2400B4	8	DST3-36B25	7	LP30-85B125	3	ST2-12B42	7		
241-4-120A20	39	A41-25-28A31	6	DPC-10-440B2	8	DST3-48B29	7	LP34-170B11	3	ST2-16B43	7		
241-4-12A12	39	A41-25-36A37	6	DPC-10-90B53	8	DST3-56B33	7	LP34-340B12	3	ST2-20B44	7		
241-4-16A13	39	A41-43-10A2	6	DPC-120-10B37	8	DST4-10B2	7	LP34-75B28	3	ST2-24B451	7		
241-4-20A14	39	A41-43-12A8	6	DPC-120-200B40	8	DST4-120B38	7	LP40-150B13	3	ST2-28B46	7		
241-4-24A15	39	A41-43-16A14	6	DPC-120-35B38	8	DST4-12B6	7	LP40-300B14	3	ST2-36B47	7		
241-4-28A16	39	A41-43-20A20	6	DPC-120-85B39	8	DST4-16B10	7	LP40-60B29	3	ST2-48B48	7		
241-4-36A17	39	A41-43-230A43	6	DPC-120-88B63	8	DST4-20B14	7	LP40-60B29	3	ST2-56B49	7		
241-4-48A18	39	A41-43-24A26	6	DPC-12-100B5	8	DST4-24B18	7	LP56-100B15	3	ST3-10B1	7		
241-4-56A19	39	A41-43-28A32	6	DPC-12-2000B8	8	DST4-28B22	7	LP56-200B16	3	ST3-10B37	7		
241-5-10A21	39	A41-43-36A38	6	DPC-12-350B6	8	DST4-36B26	7	LP56-45B30	3	ST3-12B5	7		
241-5-120A30	39	A41-80-10A3	6	DPC-12-500B6	8	DST4-48B30	7	LP88-130B18	3	ST3-16B9	7		
241-5-12A22	39	A41-80-12A9	6	DPC-16-1500B12	8	DST4-48B34	7	LP88-130B18	3	ST3-16B9	7		
241-5-16A23	39	A41-80-16A15	6	DPC-16-260B10	8	DST5-10B3	7	LP88-65B17	3	ST3-20B13	7		
241-5-20A24	39	A41-80-20A21	6	DPC-16-55B55	8	DST5-12B7	7	PC-10-1000B3	8	ST3-24B171	7		
241-5-24A25	39	A41-80-230A44	6	DPC-16-640B11	8	DST5-16B11	7	PC-10-120B1	8	ST3-28B21	7		
241-5-28A26	39	A41-80-24A27	6	DPC-20-1200B16	8	DST5-20B15	7	PC-10-2400B4	8	ST3-36B25	7		
241-5-36A27	39	A41-80-28A33	6	DPC-20-1200B16	8	DST5-24B19	7	PC-10-440B2	8	ST3-56B33	7		
241-5-48A28	39	A41-80-36A39	6	DPC-20-1200B16	8	DST5-28B23	7	PC-120-10B37	8	ST4-10B2	7		

---

## For More Information

**Pulse Worldwide  
Headquarters**

12220 World Trade Drive  
San Diego, CA 92128  
U.S.A.

Tel: 858 674 8100  
Fax: 858 674 8262

**Pulse Europe**

Einsteinstrasse 1  
D-71083 Herrenberg  
Germany

Tel: 49 7032 7806 0  
Fax: 49 7032 7806 135

**Pulse China Headquarters**

B402, Shenzhen Academy of  
Aerospace Technology Bldg.  
10th Kejinan Road  
High-Tech Zone  
Nanshan District  
Shenzen, PR China 518057

Tel: 86 755 33966678  
Fax: 86 755 33966700

**Pulse North China**

Room 2704/2705  
Super Ocean Finance Ctr.  
2067 Yan An Road West  
Shanghai 200336  
China

Tel: 86 21 62787060  
Fax: 86 2162786973

**Pulse South Asia**

135 Joo Seng Road  
#03-02  
PM Industrial Bldg.  
Singapore 368363

Tel: 65 6287 8998  
Fax: 65 6287 8998

**Pulse North Asia**

3F, No. 198  
Zhongyuan Road  
Zhongli City  
Taoyuan County 320  
Taiwan R. O. C.

Tel: 886 3 4356768  
Fax: 886 3 4356823 (Pulse)  
Fax: 886 3 4356820 (FRE)

Performance warranty of products offered on this data sheet is limited to the parameters specified. Data is subject to change without notice. Other brand and product names mentioned herein may be trademarks or registered trademarks of their respective owners. © Copyright, 2012. Pulse Electronics, Inc. All rights reserved.

## X-ON Electronics

Largest Supplier of Electrical and Electronic Components

*Click to view similar products for [Power Transformers](#) category:*

*Click to view products by [Pulse manufacturer](#):*

Other Similar products are found below :

[1-1672275-3](#) [A41-43-20A20](#) [DST5-120B39](#) [14A-56-36B42](#) [EN2997SE61808F8](#) [9-1611461-2](#) [29768](#) [1654308-1](#) [170R](#) [ST2-12B42](#) [ST3-12B5](#) [ST6118T-R](#) [PE-68421NL](#) [PL2.5-12-130B-C](#) [PoE4W3x5.0-R](#) [POE7W3X3.3-R](#) [4000-20C02K999](#) [4001-09W15AE777](#) [48RO-5000G-SIL](#) [TRA-0130-R](#) [XON7-15/2](#) [47045010](#) [1-1611462-6](#) [1-1611760-0](#) [EN2997SE61808F9](#) [OPT110F-EAS00004AU](#) [XON25-9/24](#) [XON01349](#) [XON01200](#) [XDCA001/INER01](#) [PE-68414NL](#) [F-91X](#) [F-29U](#) [DST4-16B10](#) [DP241-8-24A55](#) [DP241-5-10A21](#) [P-8577](#) [T50-24M3](#) [1-1672277-2](#) [1-1672277-0](#) [1-1672275-5](#) [1-1672275-0](#) [4000-01V18BC999](#) [PC-24-180B18](#) [750315837](#) [750315125](#) [POE13W2VERS-R](#) [PA2380NL](#) [14A-10-12B9](#) [PE-68411NL](#)