

NOTES:

1. ROHS COMPLIANT
2. HEADER: DAP (DIALLYL PHTHALATE) WITH FLAMMABILITY RATING UL 94V-0 OR BETTER.
3. STORAGE TEMPERATURE: -20°C TO +125°C
4. COMPLIANCE TO J-STD:
  - A. J-STD-002: SOLDERABILITY AT 245°C REFLOW PROFILE
  - B. J-STD-020: LEVEL 1, NO MOISTURE SENSITIVE
  - C. J-STD-075: R7, 245°C MAXIMUM THROUGH REFLOW SOLDER
5. TO ORDER TAPE & REEL PACKAGING ADD A "T" SUFFIX TO THE PART NUMBER(i.e H5019EFNL BECOMES H5019EFNLT).

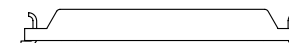
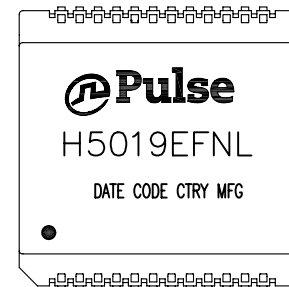

FINAL OUTLINE

© Copyright, 2014. Pulse Electronics Corp. All rights reserved. Pulse confidential & proprietary. (06/30/14)

PRODUCT DESCRIPTION	TLA DRAWING	PS DRAWING	SHEET	PART NO.	DATASHEET REV.
MDL,SIN,1GD,1:1,SM,TU	H5019EFNL-10	PS-2761.001-A	1 OF 3	H5019EFNL	A

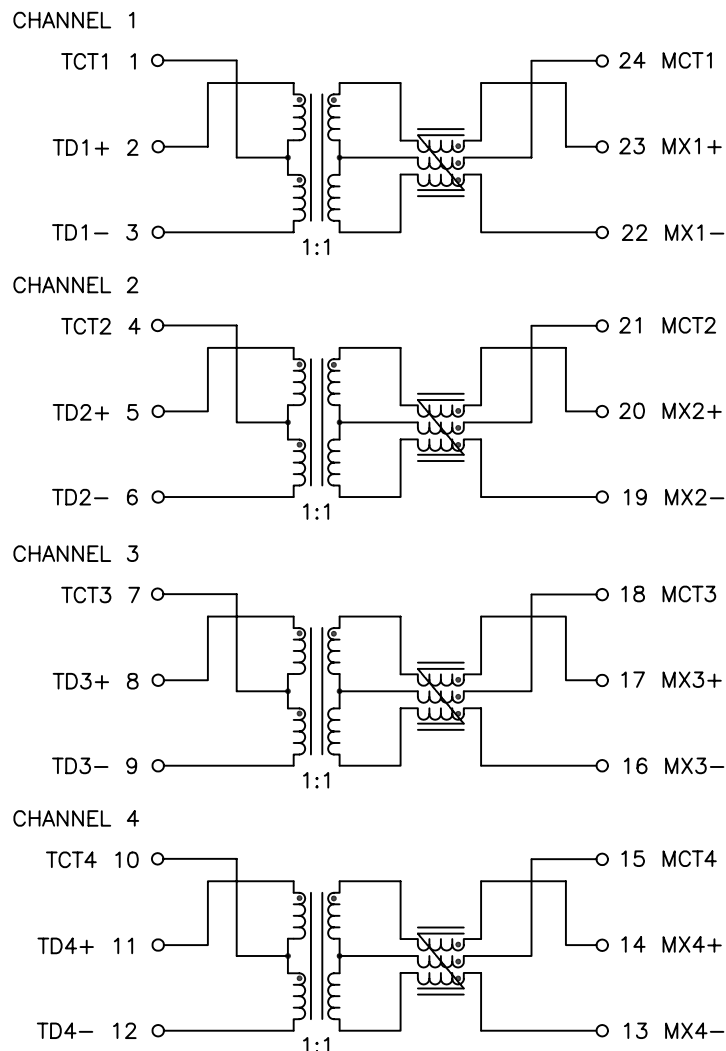

SCHMATIC

ELECTRICAL CHARACTERISTICS AT +25°C UNLESS OTHER SPECIFIED

MEETS IEEE 802.3 SPECIFICATION

PARAMETER	SPECIFICATIONS		
OPERATING TEMP	0°C – 70 °C		
TURNS RATIO	1 : 1 ±2%		
POLARITY	PER SCHEMATIC		
OCL, TRANSMIT CHANNEL	350 uH MIN. WITH 8mA DC BIAS, –0 TO 70 °C		
INSERTION LOSS	100 KHz	1–100 MHz	125 MHz
	–1.2 dB MAX	–1.0 dB MAX	–3.0 dB MAX
RETURN LOSS (Z OUT = 100 OHM ±15%)	1–40 MHz		40–100 MHz
	–16 dB MIN	–18 dB MIN (ZOUT=100 OHMS)	–10+20*LOG <sub>10</sub> (f/80) dB MIN
CROSSTALK (TX–RX)	1 MHz	30–100 MHz	
	–50 dB MIN	–55+24*LOG <sub>10</sub> (f/10) dB MIN	
DIFFERENTIAL TO COMMON MODE REJECTION	2 MHz	30–100 MHz	
	–50 dB MIN	–43+22*LOG <sub>10</sub> (f/30) dB MIN	
INPUT – OUTPUT ISOLATION	1500 VRMS @ 60 SECONDS		

NOTE: f IS FREQUENCY IN MHZ.

LEGEND

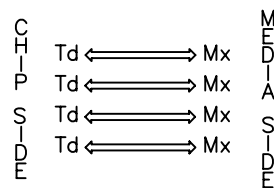

ALL CHANNELS ARE  
IN PHASE BETWEEN  
INPUT AND OUTPUT

© Copyright, 2014. Pulse Electronics Corp. All rights reserved. Pulse confidential & proprietary. (06/30/14)

PRODUCT DESCRIPTION	TLA DRAWING	PS DRAWING	SHEET	PART NO.	DATASHEET REV.
MDL,SIN,1GD,1:1,SM,TU	H5019EFNL-10	PS-2761.001-A	2 OF 3	H5019EFNL	A

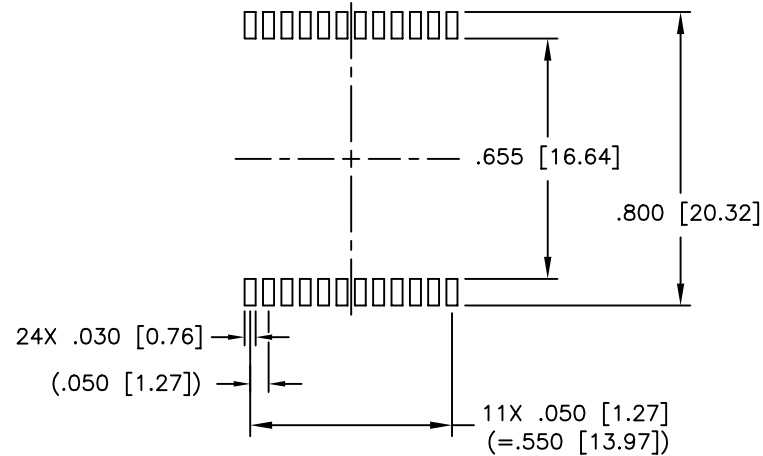
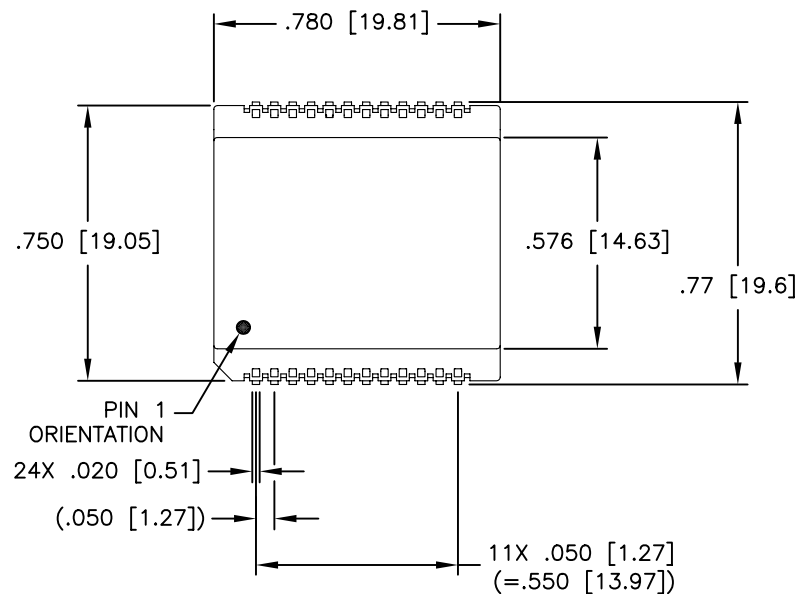

SUGGESTED LAND PATTERN

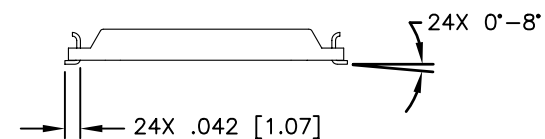
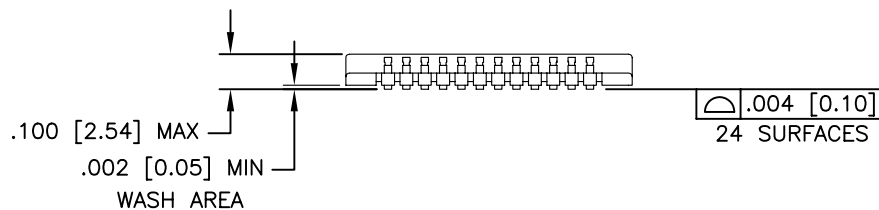

DIMENSIONS ARE IN INCHES [MILLIMETERS] WITH THE FOLLOWING TOLERANCES: [MILLIMETERS] ARE FOR REFERENCE ONLY.  
 .XX= ±.01 [±0.25]  
 .XXX= ±.005 [±0.13]

© Copyright, 2014. Pulse Electronics Corp. All rights reserved. Pulse confidential & proprietary. (06/30/14)

PRODUCT DESCRIPTION	TLA DRAWING	PS DRAWING	SHEET	PART NO.	DATASHEET REV.
MDL,SIN,1GD,1:1,SM,TU	H5019EFNL-10	PS-2761.001-A	3 OF 3	H5019EFNL	A

## X-ON Electronics

Largest Supplier of Electrical and Electronic Components

*Click to view similar products for [Audio Transformers](#) / [Signal Transformers](#) category:*

*Click to view products by [Pulse manufacturer](#):*

Other Similar products are found below :

[CX2041NLT](#) [MGPWT-00449-P](#) [PE-64961](#) [H1302FNLT](#) [H5008FNL](#) [H5012FNL](#) [H5020FNLT](#) [H5077NLT](#) [H5079NLT](#) [H5084FNLT](#)  
[B78476A9558A003](#) [1812WBT2-4](#) [1879479-1](#) [HX2260FNL](#) [HX5014FNL](#) [EX2024FNL](#) [FL1066](#) [T1137NLT](#) [T3012NL](#) [PE-65812FNL](#) [PE-65848FNLT](#) [H1174FNL](#) [H1302FNL](#) [H5015FNL](#) [H5019EFNL](#) [H5062FNLT](#) [CX2047LNL](#) [MGPWT-00059-P](#) [MGPWT-00266-P](#) [MGPWT-00278-P](#) [MGPWT-00431-P](#) [TTC-100](#) [TTC-143-H](#) [TTC-5032-1](#) [BX1194WNLT](#) [HX1234NLT](#) [HX5008FNLT](#) [HX5019FNL](#) [HX5084NL](#) [3-1879385-5](#) [TX1263NLT](#) [4-1879391-0](#) [T1142NL](#) [HX6101FNL](#) [HX5084FNL](#) [HX1148NL](#) [HX5020FNLT](#) [HX5014FNLT](#) [T1124NL](#)  
[1879732-1](#)