

NOTES:

1. ROHS COMPLIANT
2. STORAGE TEMPERATURE: -50°C TO +125°C
3. COMPLIANCE TO J-STD:
  - A. J-STD-002: SOLDERABILITY AT 245°C REFLOW PROFILE
  - B. J-STD-020: LEVEL 1, NO MOISTURE SENSITIVE
  - C. J-STD-075: R7, 245°C MAXIMUM THROUGH REFLOW SOLDER
4. TO ORDER TAPE & REEL PACKAGING ADD A "T" SUFFIX TO THE PART NUMBER(i.e HXXXXXXNL BECOMES HXXXXXXNLT).

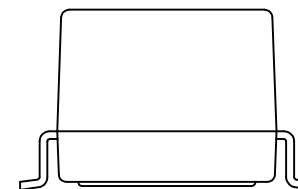
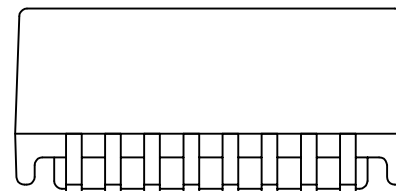
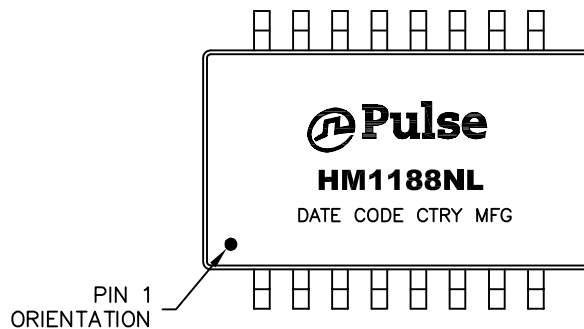

FINAL OUTLINE

© Copyright, 2016. Pulse Electronics Corp. All rights reserved. Pulse confidential & proprietary. (09/05/16)

PRODUCT DESCRIPTION  
MDL,SIN,100D,1:1,SM,TU

TLA DRAWING  
HM1188NL-10

PS DRAWING  
PS-2005.001-F

SHEET  
1 OF 3

PART NO.  
HM1188NL

DATASHEET REV.  
E

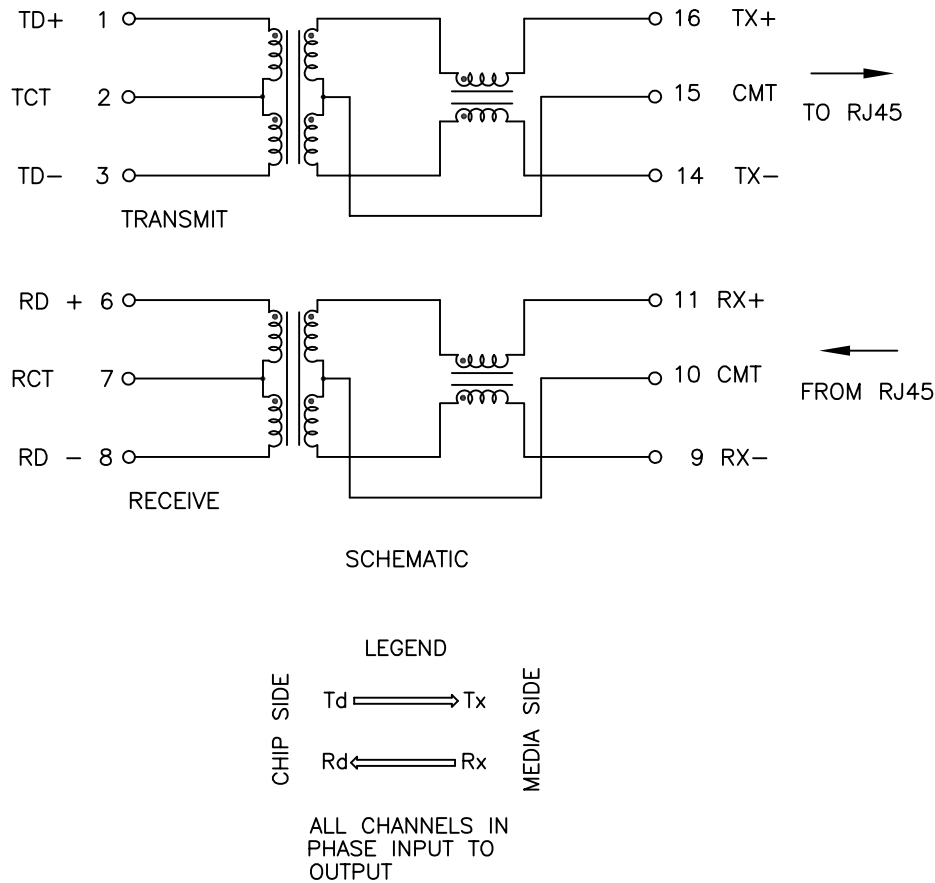

ELECTRICAL CHARACTERISTICS AT +25°C UNLESS OTHER SPECIFIED  
MEETS IEEE 802.3 SPECIFICATION

PARAMETER	SPECIFICATIONS	
OPERATING TEMP	-40°C TO +105°C	
TURNS RATIO	1 : 1 ±2%	
POLARITY	PER SCHEMATIC	
INDUCTANCE (OCL) (MEDIA SIDE, -40°C~+105°C)	350 uH MIN (MEASURED AT 100 KHz, 100 mVRMS) (AND WITH 8 mA DC BIAS)	
INSERTION LOSS	1-100 MHz	125 MHz
	-1.0 dB MAX	-3.0 dB MAX
RETURN LOSS Z <sub>OUT</sub> = 100 OHMS	5 MHz	30-80 MHz
	-18 dB MIN	-16 + 26LOG <sub>10</sub> (f/30 MHz) dB MIN
CROSSTALK (TX-RX)	1 MHz	5-100 MHz
	-62 dB MIN	-45 + 21LOG <sub>10</sub> (f/30 MHz) dB MIN
DIFFERENTIAL TO COMMON MODE REJECTION	5-200 MHz	
	-50 + 17LOG <sub>10</sub> (f/5 MHz) dB MIN	
INPUT - OUTPUT ISOLATION	1500 VAC MINIMUM FOR 60 SECONDS	

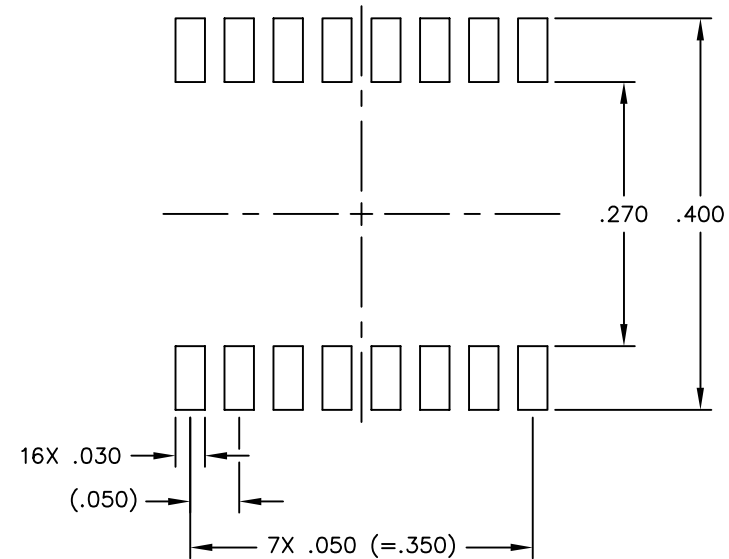
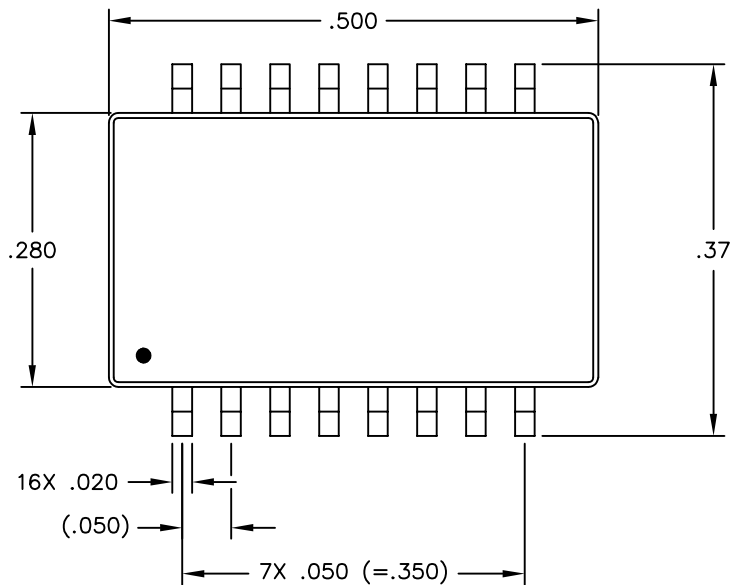

SUGGESTED LAND PATTERN

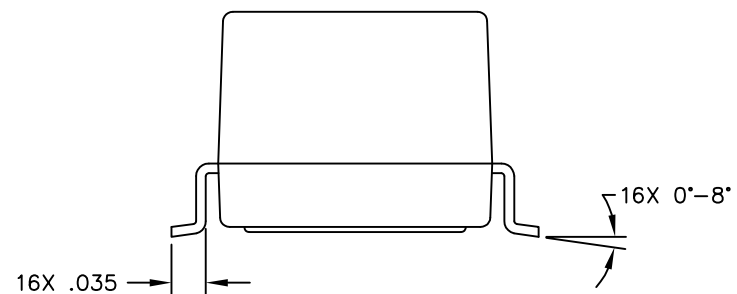
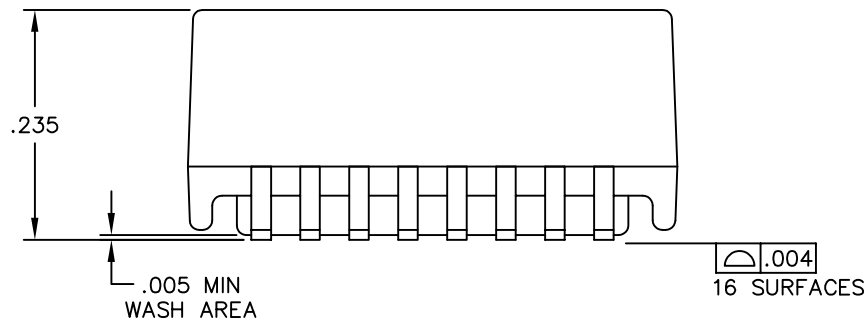

DIMENSIONS ARE IN INCHES WITH THE FOLLOWING TOLERANCES:

.XX= ±.01  
.XXX= ±.005

© Copyright, 2016. Pulse Electronics Corp. All rights reserved. Pulse confidential & proprietary. (09/05/16)

PRODUCT DESCRIPTION  
MDL,SIN,100D,1:1,SM,TU

TLA DRAWING  
HM1188NL-10

PS DRAWING  
PS-2005.001-F

SHEET  
3 OF 3

PART NO.  
HM1188NL

DATASHEET REV.  
E

## X-ON Electronics

Largest Supplier of Electrical and Electronic Components

*Click to view similar products for [Audio Transformers](#) / [Signal Transformers](#) category:*

*Click to view products by [Pulse manufacturer](#):*

Other Similar products are found below :

[CX2041NLT](#) [MGPWT-00449-P](#) [PE-64961](#) [H1302FNLT](#) [H5008FNL](#) [H5012FNL](#) [H5020FNLT](#) [H5077NLT](#) [H5084FNLT](#)  
[B78476A9558A003](#) [1812WBT2-4](#) [1879479-1](#) [HX2260FNL](#) [HX5014FNL](#) [EX2024FNL](#) [FL1066](#) [T1137NLT](#) [T3012NL](#) [PE-65812FNL](#) [PE-65848FNLT](#) [H1174FNL](#) [H1302FNL](#) [H5015FNL](#) [H5019EFNL](#) [H5062FNLT](#) [CX2047LNL](#) [MGPWT-00059-P](#) [MGPWT-00266-P](#) [MGPWT-00278-P](#) [MGPWT-00431-P](#) [TTC-100](#) [TTC-143-H](#) [TTC-5032-1](#) [BX1194WNLT](#) [HX1234NLT](#) [HX5008FNLT](#) [HX5019FNL](#) [HX5084NL](#) [3-1879385-5](#) [TX1263NLT](#) [4-1879391-0](#) [T1142NL](#) [HX6101FNL](#) [HX5084FNL](#) [HX1148NL](#) [HX5020FNLT](#) [HX5014FNLT](#) [T1124NL](#)  
[1879732-1](#) [2-1879391-5](#)