

NOTES:

1. ROHS COMPLIANT
2. STORAGE TEMPERATURE: -50°C TO +125°C
3. COMPLIANCE TO J-STD:
 - A. J-STD-002: SOLDERABILITY AT 245°C REFLOW PROFILE
 - B. J-STD-020: LEVEL 1, NO MOISTURE SENSITIVE
 - C. J-STD-075: R7, 245°C MAXIMUM THROUGH REFLOW SOLDER
4. TO ORDER TAPE & REEL PACKAGING ADD A "T" SUFFIX TO THE PART NUMBER(i.e HXXXXXXXXNL BECOMES HXXXXXXXXNLT).
5. MEETS AEC-Q200 REQUIREMENTS

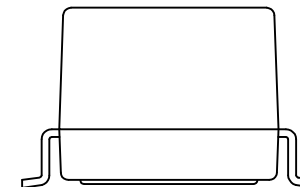
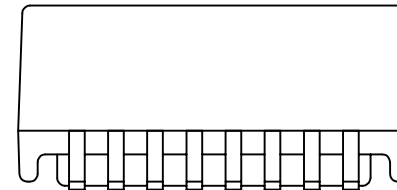
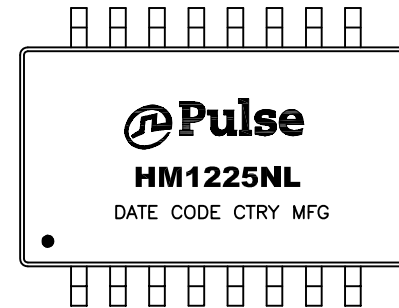

FINAL OUTLINE

© Copyright, 2016. Pulse Electronics Corp. All rights reserved. Pulse confidential & proprietary. (09/14/16)

PRODUCT DESCRIPTION	TLA DRAWING	PS DRAWING	SHEET	PART NO.	DATASHEET REV.
MDL,SIN,100D,1:1/1.5:1,SM,TU	HM1225NL-10	PS-2005.001-F	1 OF 3	HM1225NL	C

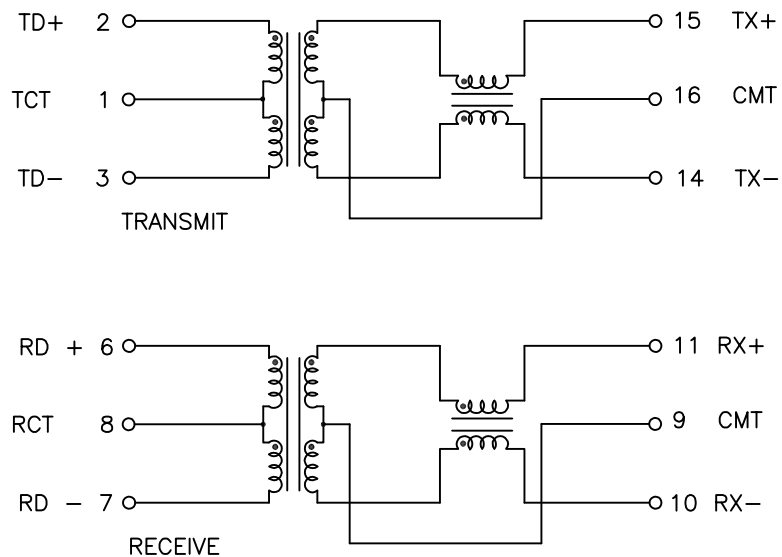

SCHEMATIC

ELECTRICAL CHARACTERISTICS AT +25°C UNLESS OTHERWISE SPECIFIED
(FOR REFERENCE ONLY. USED FOR CUSTOMER INFORMATION.)

PARAMETER	SPECIFICATIONS							
OPERATING TEMP	-40°C TO +95°C							
URNS RATIO	1 : 1 ±3%							
POLARITY	PER SCHEMATIC							
TRUNS RATIO	TRANSMIT				RECEIVE			
	1:1(±2%)				1.5:1(±2%)			
INSERTION LOSS	1-50 MHz				1-50 MHz			
	-1.0 dB MAX.				-1.5 dB MAX.			
RETURN LOSS Z _{OUT} = 100 OHMS	0.5~40 MHz	60 MHz	80 MHz	0.5MHz	40 MHz	60 MHz	80 MHz	
	-18 dB MIN.	-14.5 dB MIN.	-12 dB MIN.	-18 dB MIN.	-10 dB MIN.	-8 dB MIN.	-6 dB MIN.	
CROSSTALK	30 MHz		60 MHz		100 MHz			
	-45 dB		-35 dB		-30 dB			
OCL	200 uH MIN		MEASURED AT 100 KHz, 100 mVRMS, AT +25 °C					
	100 uH MIN		MEASURED AT 100 KHz, 100 mVRMS, AT -40 °C					
C _{ww}	100 uH MIN		MEASURED AT 100 KHz, 100 mVRMS, AT +95 °C					
	18 pF MAX		MEASURED AT 100 KHz, 100 mVRMS					
ISOLATION (INPUT - OUTPUT)	1650 VRMS, 6 SECONDS MAX							

© Copyright, 2016. Pulse Electronics Corp. All rights reserved. Pulse confidential & proprietary. (09/14/16)

PRODUCT DESCRIPTION	TLA DRAWING	PS DRAWING	SHEET	PART NO.	DATASHEET REV.
MDL,SIN,100D,1:1/1.5:1,SM,TU	HM1225NL-10	PS-2005.001-F	2 OF 3	HM1225NL	C

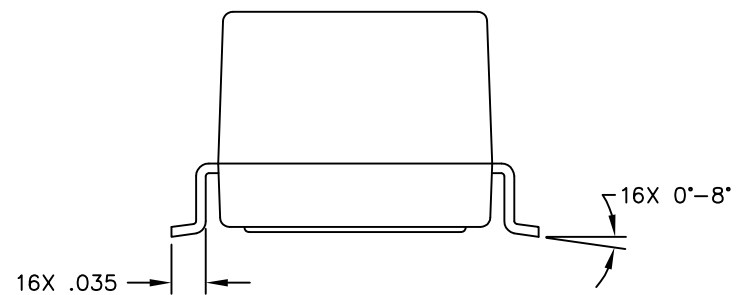
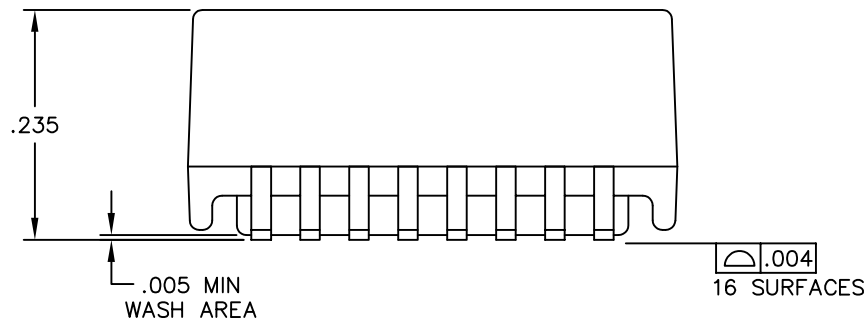
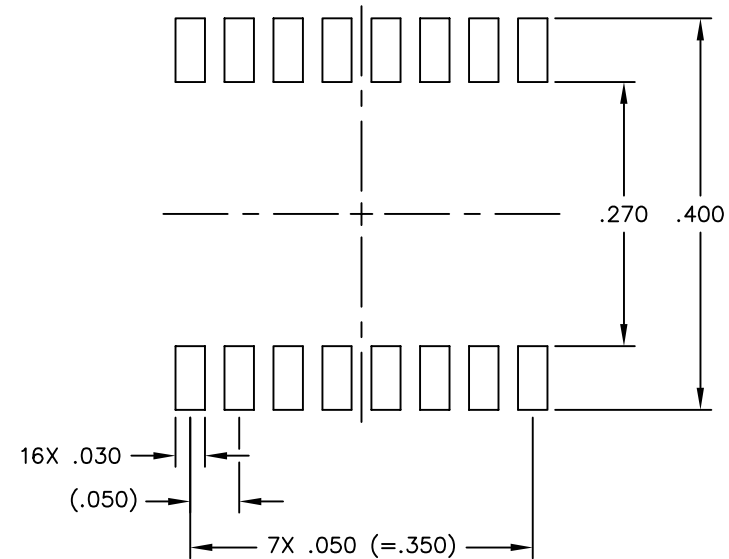
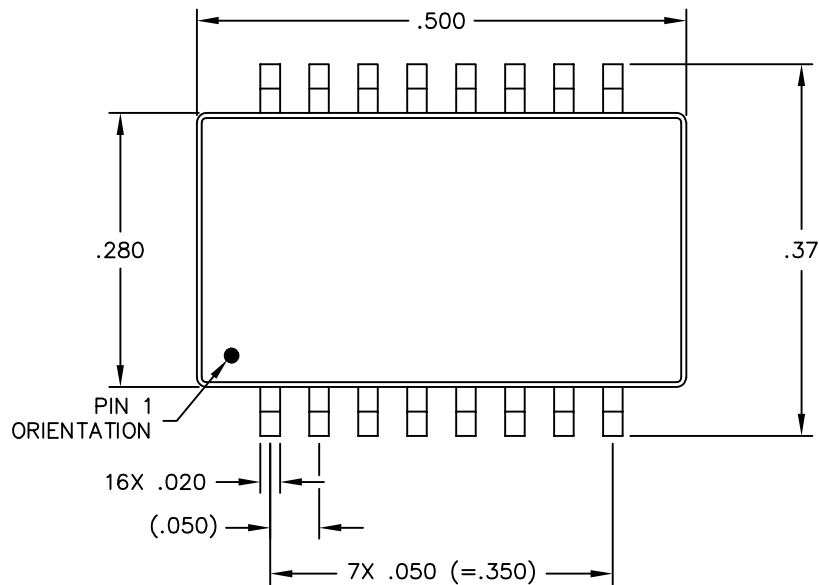

DIMENSIONS ARE IN INCHES WITH THE FOLLOWING TOLERANCES:

.XX= ±.01
.XXX= ±.005

© Copyright, 2016. Pulse Electronics Corp. All rights reserved. Pulse confidential & proprietary. (09/14/16)

PRODUCT DESCRIPTION	TLA DRAWING	PS DRAWING	SHEET	PART NO.	DATASHEET REV.
MDL,SIN,100D,1:1/1.5:1,SM,TU	HM1225NL-10	PS-2005.001-F	3 OF 3	HM1225NL	C

X-ON Electronics

Largest Supplier of Electrical and Electronic Components

Click to view similar products for [Audio Transformers](#) / [Signal Transformers](#) category:

Click to view products by [Pulse manufacturer](#):

Other Similar products are found below :

[CX2041NLT](#) [MGPWT-00449-P](#) [PE-64961](#) [H1302FNLT](#) [H5008FNL](#) [H5012FNL](#) [H5020FNLT](#) [H5077NLT](#) [H5084FNLT](#)
[B78476A9558A003](#) [1812WBT2-4](#) [1879479-1](#) [HX2260FNL](#) [HX5014FNL](#) [EX2024FNL](#) [FL1066](#) [T1137NLT](#) [T3012NL](#) [PE-65812FNL](#) [PE-65848FNLT](#) [H1174FNL](#) [H1302FNL](#) [H5015FNL](#) [H5019EFNL](#) [H5062FNLT](#) [CX2047LNL](#) [MGPWT-00059-P](#) [MGPWT-00266-P](#) [MGPWT-00278-P](#) [MGPWT-00431-P](#) [TTC-100](#) [TTC-143-H](#) [TTC-5032-1](#) [BX1194WNLT](#) [HX1234NLT](#) [HX5008FNLT](#) [HX5019FNL](#) [HX5084NL](#) [3-1879385-5](#) [TX1263NLT](#) [4-1879391-0](#) [T1142NL](#) [HX6101FNL](#) [HX5084FNL](#) [HX1148NL](#) [HX5020FNLT](#) [HX5014FNLT](#) [T1124NL](#)
[1879732-1](#) [2-1879391-5](#)