

NOTES: UNLESS OTHERWISE SPECIFIED

1.

NOTICE:	THIS IS A RoHS COMPLIANT COMPONENT/PRODUCT. ALL ENGINEERING CHANGES MUST HAVE PRIOR APPROVAL BY THE DESIGN CENTER.
RoHS-6 	

2. PLASTIC: THERMOSET PLASTIC MATERIAL WITH FLAMMABILITY RATING UL 94V-0 OR BETTER.
3. SOLDERABILITY: CONFORMS TO ANSI/J-STD-002 245°C REFLOW PEAK TEMPERATURE PER IPC/EIA J-STD-003A
4. OPERATING TEMPERATURE: -40°C TO +85°C
5. STORAGE TEMPERATURE: -50°C TO +125°C
6. JEDEC MOISTURE: LEVEL 1.
7. DIMENSIONS ARE IN INCHES [MILLIMETERS] WITH THE FOLLOWING TOLERANCES: [MILLIMETERS] ARE FOR REFERENCE ONLY.
.XX= ±0.01 [±0.25]
.XXX= ±0.005 [±0.13]

ELECTRICAL CHARACTERISTICS:
ELECTRICAL: @ +25°C

PARAMETER	SPECIFICATIONS
OPERATING TEMP	-40°C ~ +85°C
TURNS RATIO	1.00 ± 2%
POLARITY	PER SCHEMATIC
INDUCTANCE (OCL) (MEDIA SIDE, -40 ~ +85°C)	350 uH MIN (MEASURED AT 100 KHz, 100 mVRMS) (AND WITH 8 mA DC BIAS) 440 uH MIN AT +25°C
DC RESISTANCE	1-3, 16-14, 6-8, 11-9 = 1.50 OHMS MAXIMUM
LEAKAGE INDUCTANCE 100 KHz, 100 mV	(1-3) WITH (16-14) SHORTED=0.3uH MAX (6-8) WITH (11-9) SHORTED=0.3uH MAX
INSERTION LOSS	1-100 MHz 125 MHz
	-1.0 dB MAX -3.0 dB MAX
RETURN LOSS Z _{OUT} = 100 OHMS	5 MHz 30-60 MHz 60-80 MHz
	-18 dB MIN -10+20LOG ₁₀ (f/60 MHz) dB MIN -10 dB MIN
CROSSTALK (TX-RX)	1 MHz 5-100 MHz
	-62 dB MIN -45 + 21LOG ₁₀ (f/30 MHz) dB MIN
DIFFERENTIAL TO COMMON MODE REJECTION	5-200 MHz
	-50 + 17LOG ₁₀ (f/5 MHz) dB MIN
ISOLATION (INPUT - OUTPUT)	VOLTAGE
	1650 VRMS 6 SECONDS MAX

NOTE: f IS FREQUENCY IN MHz.



TRANSMIT

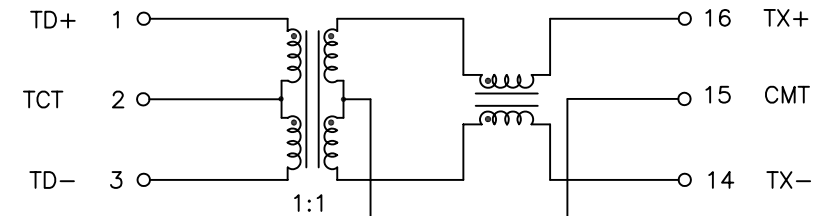

RECEIVE

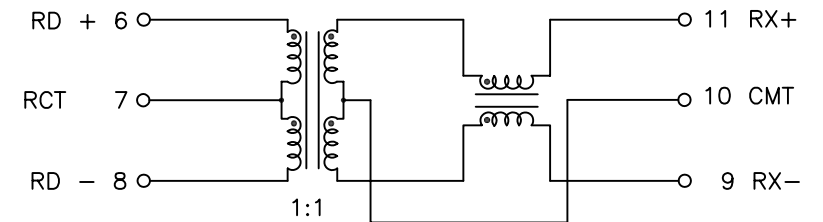

SCHEMATIC

© Copyright, 2013. Pulse Electronics, Inc. All rights reserved. Drawing specifications subject to change without notice. (10/29/13)

PULSE CONFIDENTIAL
&
PROPRIETARY

PRODUCT DESCRIPTION
MDL,SIN,100D,1:1,SMT

PS DRAWING
PS-2005.002-D

SHEET:
1

DWG. NO./ PART NO.
HX1188FNL

REV.
M13

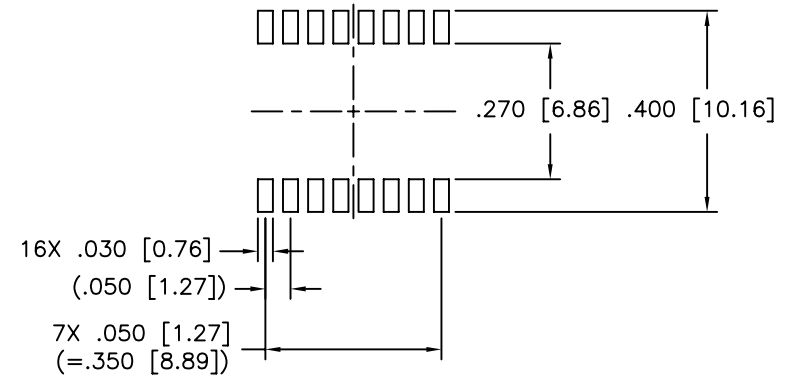
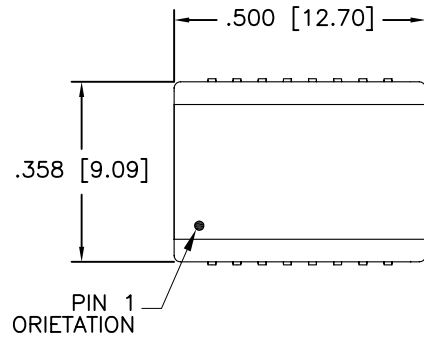

SUGGESTED LAND PATTERN

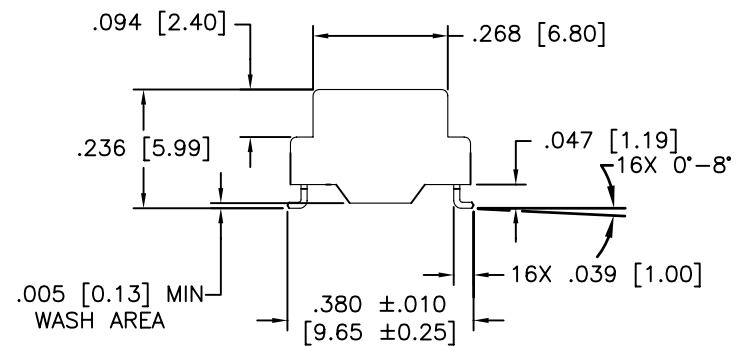
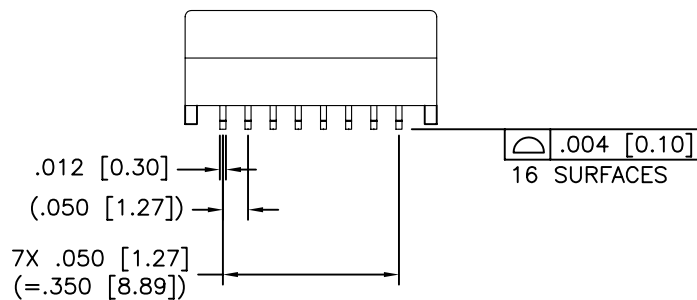

X-ON Electronics

Largest Supplier of Electrical and Electronic Components

Click to view similar products for [Audio Transformers](#) / [Signal Transformers](#) category:

Click to view products by [Pulse manufacturer](#):

Other Similar products are found below :

[CX2041NLT](#) [MGPWT-00449-P](#) [PE-64961](#) [H1302FNLT](#) [H5008FNL](#) [H5012FNL](#) [H5020FNLT](#) [H5077NLT](#) [H5079NLT](#) [H5084FNLT](#)
[B78476A9558A003](#) [1812WBT2-4](#) [1879479-1](#) [HX2260FNL](#) [HX5014FNL](#) [EX2024FNL](#) [FL1066](#) [T1137NLT](#) [T3012NL](#) [PE-65812FNL](#) [PE-65848FNLT](#) [H1174FNL](#) [H1302FNL](#) [H5015FNL](#) [H5019EFNL](#) [H5062FNLT](#) [CX2047LNL](#) [MGPWT-00059-P](#) [MGPWT-00266-P](#) [MGPWT-00278-P](#) [MGPWT-00431-P](#) [TTC-100](#) [TTC-143-H](#) [TTC-5032-1](#) [BX1194WNLT](#) [HX1234NLT](#) [HX5008FNLT](#) [HX5019FNL](#) [HX5084NL](#) [3-1879385-5](#) [TX1263NLT](#) [4-1879391-0](#) [T1142NL](#) [HX6101FNL](#) [HX5084FNL](#) [HX1148NL](#) [HX5020FNLT](#) [HX5014FNLT](#) [T1124NL](#)
[1879732-1](#)