

# Single Port 1Gigabit PoE SMD Magnetic Modules **Pulse**

HB5005HLT, HB5006HLT, HXB5008HLT, HB5004HLT, HB5009HLT,  
HXB5007HLT, HB5010HLT, HB5011HLT, HXB5011HLT and HXB6020HLT

a YAGEO company

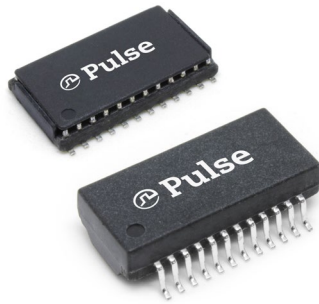

- Ⓢ Fully RoHS and Halogen Free
- Ⓢ Single port, Low profile compact footprint
- Ⓢ Supports 30 & 60 Watt, 4pair Power over Ethernet
- Ⓢ Meet or exceed IEEE802.3ab/af/at for 1000Base-T
- Ⓢ Compatible with all 1:1 turns ration PHYs
- Ⓢ Commercial and Industrial Temperature
- Ⓢ Reliable SMD packages support 245°C pk Reflow
- Ⓢ All components Supplied in Tape and Reel

## Electrical Specification @ 25°C (OCL@ 8mA DC)

Part Number	Media side Inductance (@100KHz/0.1Ve) uH min	Insertion Loss (dB max)	Return Loss (dB min)		PoE (Current Per Pair mA)	Operating Temperature (°C)	Isolation (Pri:Sec)	Note
			1-100 MHz	1-40MHz				
HB5005HLT	350	-1.0	-16	-(10-20 log10(f/80))	350	0 to 70°	1500Vrms	30W PoE 4 Pair
HB5006HLT	350	-1.0	-16	-(10-20 log10(f/80))	350	0 to 70°	1500Vrms	30W PoE 4 Pair
HXB5008HLT	350	-1.0	-16	-(10-20 log10(f/80))	350	-40° to 85°	1500Vrms	30W PoE 4 Pair
HB5004HLT	350	-1.0	-16	-(10-20 log10(f/80))	350	0 to 70°	1500Vrms	30W PoE 4 Pair
HB5009HLT	350	-1.0	-16	-(10-20 log10(f/80))	350	0 to 70°	1500Vrms	30W PoE 4 Pair
HXB5007HLT	350	-1.0	-16	-(10-20 log10(f/80))	350	-40° to 85°	1500Vrms	30W PoE 4 Pair
HB5010HLT	350	-1.0	-16	-(10-20 log10(f/80))	350	0 to 70°	1500Vrms	30W PoE, Surge 2.5KV
HXB6020HLT	350	-1.0	-16	-(10-20 log10(f/80))	720	-40° to 85°	1500Vrms	60W PoE 4 Pair

Note: \*Specifications listed above refer to the base component part number that is printed on the product - ie HXB5007HLT will be HXB5007HL

## Electrical Specification @ 25°C (OCL@ 8mA DC)

Part Number	Media side Inductance (@100KHz/0.1Ve) uH min	Insertion Loss (dB max)	Return Loss (dB min)		PoE (Current Per Pair mA)	Operating Temperature (°C)	Isolation (Pri:Sec)	Note
			1-100 MHz	1-40MHz				
HB5011HLT	350	-1.0	-16	-(10-20 log10(f/80))	-	0 to 70°	1500Vrms	PCMCIA
HXB5011HLT	350	-1.0	-16	-(10-20 log10(f/80))	-	-40 to 85°	1500Vrms	PCMCIA

Note: \*Specifications listed above refer to the base component part number that is printed on the product - ie HXB5011HLT will be HXB5011HL

## Process and Materials

### Notes:

1. Storage Temperature:  
HBxxxxHL = -20 to +125°C  
HXBxxxxHL = -50 to +125°C
2. Compliance to JEDEC-J-STD 020:  
i. Moisture Sensitive Level 1  
ii. Maximum peak Reflow Solder temperature 245°C
3. All parts come in 13" (330mm) Diameter Tape and reel - see page 3 for details
4. Header: Black Thermoset Plastic - Material flammability rating UL 94V-0
5. Lead Frame: Cooper Alloy
6. Underplate / Overplate: Tin electro-deposited over Nickel
7. Finish: Matte finish Tin solder

# Single Port 1Gigabit PoE SMD Magnetic Modules

HB5005HLT, HB5006HLT, HXB5008HLT, HB5004HLT, HB5009HLT,  
HXB5007HLT, HB5010HLT, HB5011HLT, HXB5011HLT and HXB6020HLT



# Pulse

a YAGEO company

## Mechanicals

### HB5004/5/6/9/10HLT, HXB5007/8HLT, HXB6020HLT

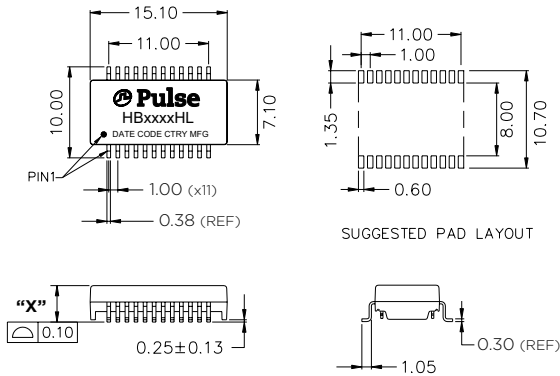

#### Dimensions "X"

All parts the height is 4.00mm except for HXB6020HLT when it is 5.80mm

### HB5011HLT, HXB5011HLT

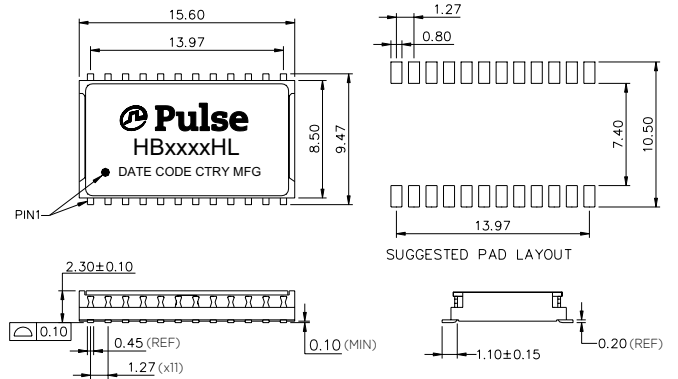

#### Dimensions: mm

Unless otherwise specified, all tolerances are ± 0,25

## Schematics

### HB5005HLT, HXB5007HLT, HB5010HLT

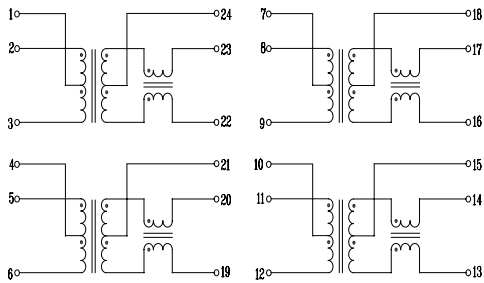

### HB5006HLT, HXB5008HLT, HXB6020HLT

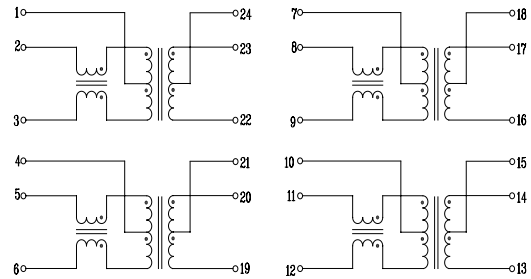

### HB5009HLT

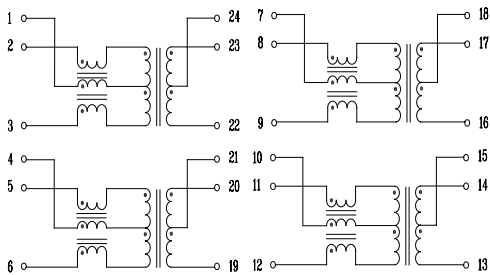

### HB5004HLT

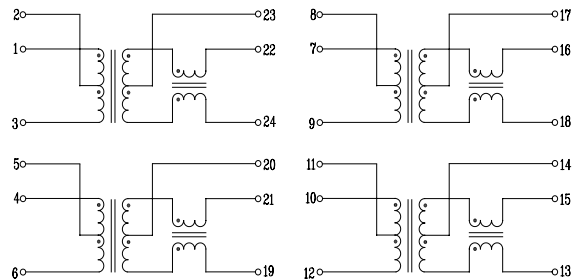

### HXB/HB5011HLT

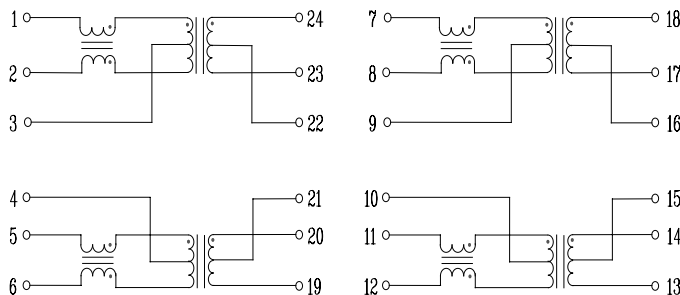

# Single Port 1Gigabit PoE SMD Magnetic Modules

HB5005HLT, HB5006HLT, HXB5008HLT, HB5004HLT, HB5009HLT,  
HXB5007HLT, HB5010HLT, HB5011HLT, HXB5011HLT and HXB6020HLT

## Tape & Reel

### HB5004/5/6/9/10HLT, HXB5007/8HLT, HXB6020HLT

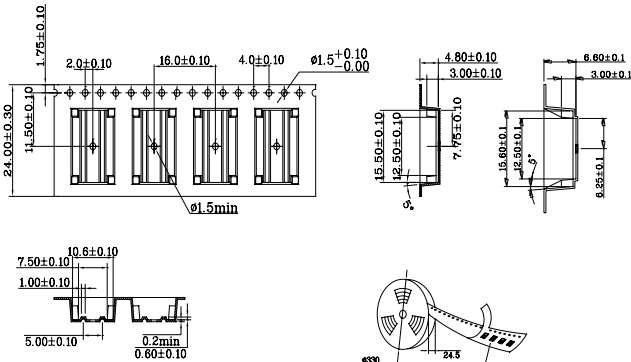

1. Material : Black Anti-Static polystyrene.
2. 10 sprocket hole pitch cumulative tolerance  $\pm 0.20$
3. All dimensions meet EIA-481-E requirements
4. Thickness :  $0.40 \pm 0.05$
5. Component load per 13"

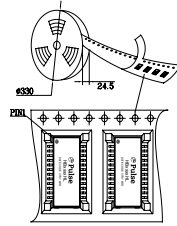

### HB5011HLT, HXB5011HLT

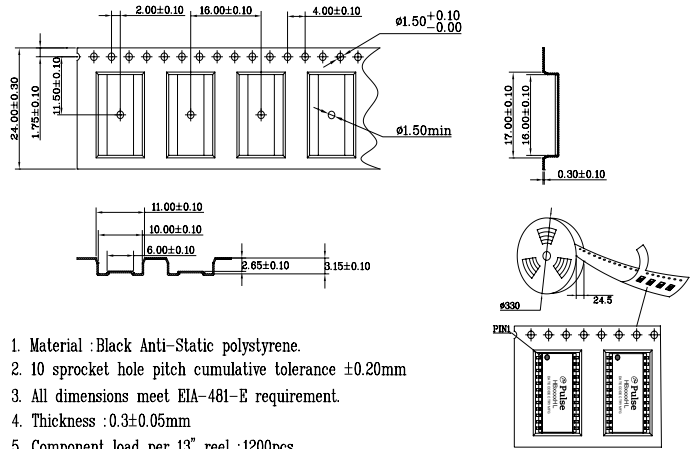

1. Material : Black Anti-Static polystyrene.
2. 10 sprocket hole pitch cumulative tolerance  $\pm 0.20$ mm
3. All dimensions meet EIA-481-E requirement.
4. Thickness :  $0.3 \pm 0.05$ mm
5. Component load per 13" reel : 1200pcs .

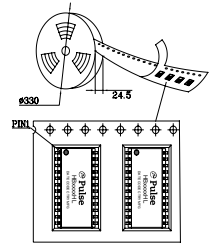

## Carton Package

### HB5004/5/6/9/10HLT, HXB5007/8HLT, HXB6020HLT



REEL

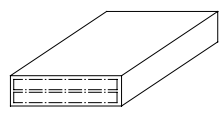

INNER BOX: 347x347x82

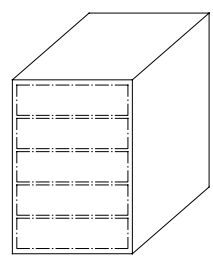

OUTER CARTON: 375x375x470

- HB/HXB50xxHLT
1. FULL REEL = 780PCS
  2. INNER BOX = 2 REELS = 1560PCS
  3. OUTER CARTON = 5 INNER BOXES = 7800PCS

- HXB6020HLT
1. FULL REEL = 600PCS
  2. INNER BOX = 2 REELS = 1200PCS
  3. OUTER CARTON = 5 INNER BOXES = 6000PCS

### HB5011HLT, HXB5011HLT

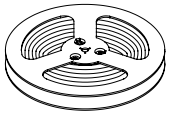

REEL

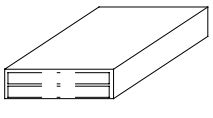

INNER BOX: 347x347x82

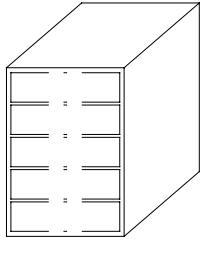

OUTER CARTON: 375x375x470

1. 1 REEL=1200PCS
2. 1 INNER BOX=2 REELS=2400PCS
3. 1 OUTER CARTON=5 INNER BOXES=12000PCS

## For More Information:

Americas - [prodinfo\\_network\\_americas@yageo.com](mailto:prodinfo_network_americas@yageo.com) | Europe - [prodinfo\\_network\\_emea@yageo.com](mailto:prodinfo_network_emea@yageo.com) | Asia - [prodinfo\\_network\\_asia@yageo.com](mailto:prodinfo_network_asia@yageo.com)

Performance warranty of products offered on this data sheet is limited to the parameters specified. Data is subject to change without notice. Other brand and product names mentioned herein may be trademarks or registered trademarks of their respective owners. © Copyright, 2024. Pulse Electronics, Inc. All rights reserved.

YAGEO Corporation and its affiliates do not recommend the use of commercial or automotive grade products for high reliability applications or manned space flight.

## X-ON Electronics

Largest Supplier of Electrical and Electronic Components

*Click to view similar products for [Audio Transformers](#) / [Signal Transformers](#) category:*

*Click to view products by [Pulse manufacturer](#):*

Other Similar products are found below :

[CU4S0506AT-2655-H1](#) [MGPWT-00449-P](#) [PE-64961](#) [1812WBT2-4](#) [BX1194WNL](#) [1879479-1](#) [PA1528ANL](#) [T1137NLT](#) [PE-65848FNLT](#)  
[H5019EFNL](#) [CX2045ALNLT](#) [TG1G-E201NV6LF](#) [MGPWT-00059-P](#) [MGPWT-00266-P](#) [MGPWT-00278-P](#) [MGPWT-00431-P](#) [TTC-100](#)  
[TTC-143-H](#) [TTC-5032-1](#) [4-1879391-0](#) [100213](#) [T1142NL](#) [TG1G-S001NZLF](#) [T1124NL](#) [1879732-1](#) [2-1879391-5](#) [MABA-010321-CT1A42](#)  
[TX1341NL](#) [H0013FNL](#) [H5020FNL](#) [H2009FNLT](#) [H5004NLT](#) [S553-5999-52-F](#) [SCMS7D43AY100PT1](#) [T5008NLT](#) [PE-68517T](#) [MGPWT-](#)  
[00339-P](#) [H5014FNLT](#) [TX1473NLT](#) [PE-69011NLT](#) [CX2043LNLT](#) [H7137FNLT](#) [H1259NLT](#) [TX1344NLT](#) [LM-LP-1005L](#) [H0013NLT](#)  
[S558-5500-JV](#) [TX1193NLT](#) [T7015NL](#) [T1124NLT](#)