

Description:

Industrial Fast Ethernet and/or Gigabit (10/100/1000Base-T) single port RJ45 in top entry form with integrated magnetics and stand-off features which provide support for the component above the PCB to facilitate through hole reflow processing



- Ⓢ Top entry, small footprint to minimize board space
- Ⓢ Exceeds IEEE 802.3 specifications, RoHS6 and WEEE
- Ⓢ High performance materials support THR/Pin-in-Paste
- Ⓢ Survives 260°C reflow processing
- Ⓢ Incorporates Stand-offs for Solder Masking on component side of PCB

Electrical Specifications @ 25°C - Operating Temperature -40°C to +85°C

Part Number	LEDs ¹	Speed	EMI Tabs	Insertion Loss TX/RX (dB)	Return Loss (dB MIN) 100.Ω (±15Ω)					Cross Talk (dB TYP)			Common Mode Rejection (dB TYP)	Hipot (MIN)
					1-100 MHz	1-30 MHz	30-60 MHz	60-80 MHz	80-100 MHz	1-10 MHz	32-65 MHz	65-100 MHz		
JX3V-9001NL	none	10/100BT	N/A	-1.2	-16	-12	-10	-	-40	-35	-30	-30	2250VDC	
JX3V-9010NL	G/Y	10/100BT	N/A	-1.2	-16	-12	-10	-	-40	-35	-30	-30	2250VDC	
JX3V-9015NL	Y/G	10/100/1000BT	N/A	-1.0	-16	-12	-10	-8	-40	-35	-30	-30	2250VDC	
JX3V-9025NL	Y/G	10/100/1000BT	N/A	-1.0	-16	-12	-10	-8	-40	-35	-30	-30	2250VDC	

Notes: 1. LEDs Left/Right G = green, Y = yellow

RJ45 Durability Testing Rating

Part Number	Mating Force (MAX)	Unmating Force (MAX)	Durability	Plug to Jack Retention (MIN)
JX3V Series ¹	5 lbs./2.268 kgs.	5 lbs./2.268 kgs.	750 Insertions	20 lbs./9.072 kgs.

RJ45 Material Specification

Part Number	Shield		Contact			Housing		MSL ² Rating
	Material	Finish	Material	Plating Area	Solder Area	Material	Specification	
JX3V Series	Brass	30-50μ inches thick nickel over brass	Phosphor Bronze	30μ inches gold over 50μ inches nickel	Tin matte finish over nickel	Thermoplastic	UL 94 V-0	1

Notes: 1. Connector dimensions comply with FCC dimension requirements.

2. MSL - Moisture Sensitivity Level

3. Storage Temperature: -50 to +125°C

4. Solderability:

J-STD-002: Solderability at 245oC dip and look test.

J-STD 075: W2 270oC Max through Wave Solder

J-STD-075: R4, 260oC Max Reflow Solder

MECHANICALS

JX3V-9001NL, JX3V-9010NL

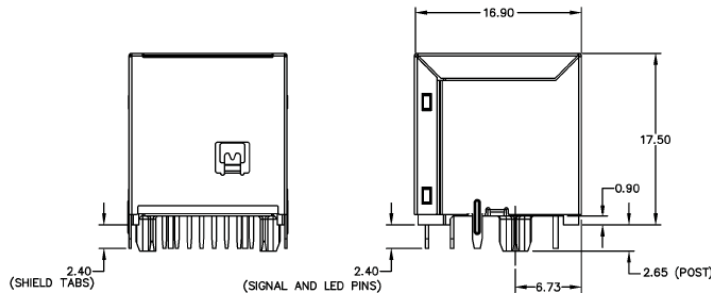

LED pins omitted on JX3V-9001NL

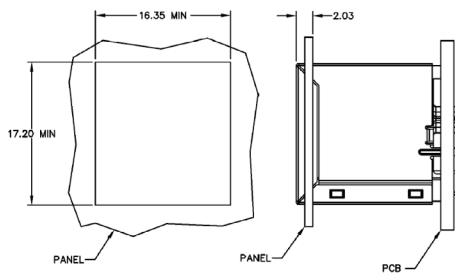

Panel Cutout and Mounting Guide

JX3V-9001NL without LEDs

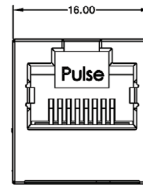

JX3V-9010NL with LEDs

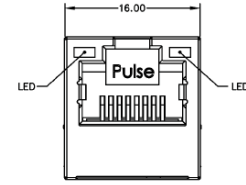

PCB Layout for JX3V-9001NL
Omit Pins 9, 10, 11 and 12

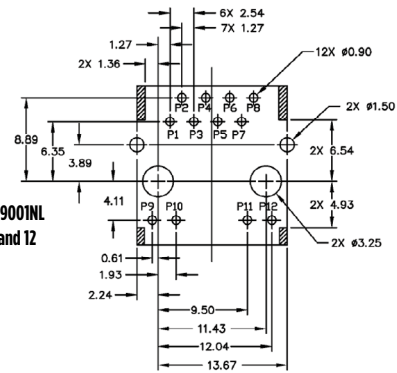

SUGGESTED FOOTPRINT (COMPONENT SIDE SHOWN)
▨ = PART STANDOFF AREA

Dimensions:

Unless otherwise specified,
all tolerances are $\pm 0,25$

SCHEMATICS

JX3V-9001NL, JX3V-9010NL

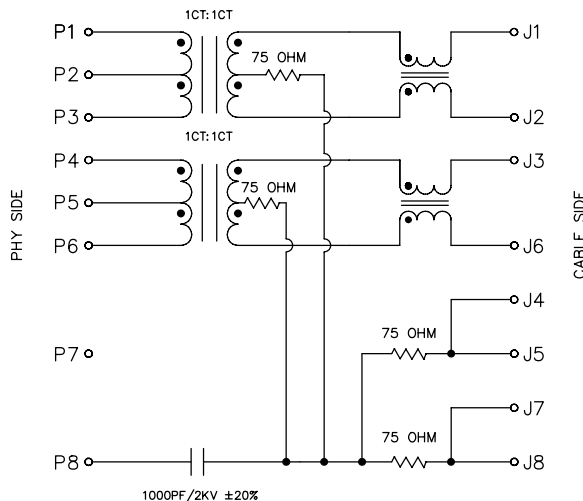

LED SPECIFICATIONS

JX3V-9010NL LED's

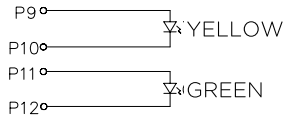

JX3V-9015NL, JX3V-9025NL LED's

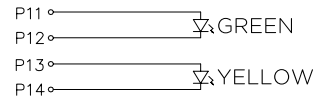

EMITTED COLOR	GREEN	YELLOW
WAVELENGTH (nm)	565	590
POWER DISSIPATION (Pd)	105 mW MAX	105 mW MAX
DC FORWARD CURRENT	20 mA MAX	20 mA MAX
FORWARD VOLTAGE (VF) @ 20 mA	2.2V TYP	2.1V TYP

Note: Per Vendor Specification

SUGGESTED SOLDER MASK

JX3V-90xxNL

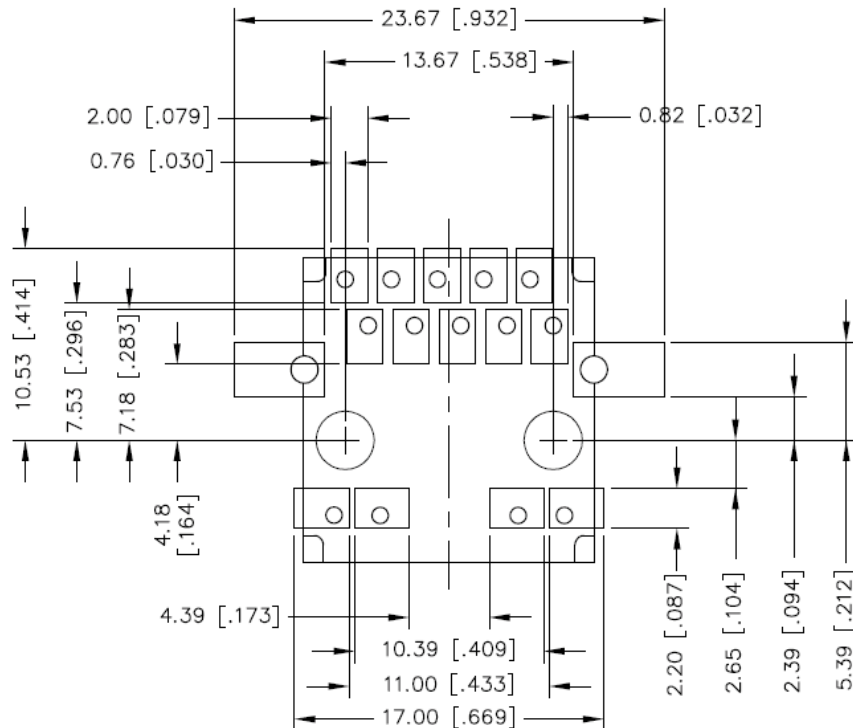

X-ON Electronics

Largest Supplier of Electrical and Electronic Components

Click to view similar products for [Modular Connectors](#) / [Ethernet Connectors](#) category:

Click to view products by [Pulse manufacturer](#):

Other Similar products are found below :

[8949-H88/06BLKA/SN](#) [74441-0010/BKN](#) [PHP-6P6C-5](#) [GAX-3-66](#) [GAX-8-62](#) [GDCX-PN-66](#) [GLX-A-44](#) [GLX-N-1010M-BLK](#) [GMX-SMT4-N-88](#) [GSGX-N-2-88](#) [GSGX-N-4-88](#) [GSX-NS2-88-3.05](#) [GSX-NS-88-3.68](#) [PT-108A-8C-UL](#) [PTS-J531-8CS-50UL](#) [A-2014-0-4](#)
[GWLX-S9-88-YG](#) [DC-1021-8-WH-6](#) [1300530003](#) [1324640-4](#) [RJ11FTVC2G](#) [RJ11FTVC2N](#) [RJFTVX2SA1G](#) [132764-001](#) [1413235](#)
[MPS88RX-5000](#) [E5288-S000K3-L](#) [155302-001](#) [AX101050](#) [AX101063](#) [AX101065](#) [AX101072](#) [AX101307](#) [AX101315](#) [AX101318](#)
[AX102271](#) [AX102288](#) [AX102651](#) [AX102660](#) [J0012D21NL](#) [J0026D01ENL](#) [PC4D0018P](#) [8949-B88/6](#) [2-6609208-5](#) [937-SP-3088-2PC-A192](#)
[303066VFL](#) [303068V](#) [303088LFLSA](#) [303088SBL](#) [30-8603](#)