





Outdoor 5G/4G Direct Mount Salt Shaker Monopole Antenna

LPT600/71DMN and LPT600/71DMNW – 617 to 7125 MHz



Features & Applications:

-  WiFi 6E, 4G/5G FR1
-  Includes Band 71 (617-698MHz) and CBRs Bands 42 and 48 (3.4-3.7GHz)
-  Utility boxes
-  Smart metering
-  IoT Devices

Electrical specifications @ 25° C

Frequency Bands – 617-960/1710-2700/3300-4200/4400-5000/5150-5925/6000-7125 MHz

Antenna type ²	Nominal Impedance	Polarization	Radiation pattern	Power withstanding	DC Ground
Monopole	50Ω	Vertical	Omni	60W	No

Frequency (MHz)	617-960	1710-2700	3300-4200	4400-5000	5150-5925	6000-7125
VSWR	3:1	2:1	2.5:1	2.5:1	2:1	2:1
Average Peak Gain (dBi)	2.3	4.7	5.0	5.7	6.1	6.9
Average Efficiency (%)	82	84	81	67	75	67
HPBW Vertical Plane (°)	65	43	31	25	28	26

Mechanical Specifications

LPT600/71DMN or LPT600/71DMNW³

Size (Diameter x Height)	Color	Weight	Connector Type	Fixing System ⁴
40.9 (1.61") x 95.9 (3.77") mm	Black or White	163grms (0.36lbs)	N-Female	Direct Mount
Housing Material	Operating Temperature	Ingress Protection	RoHS-6 Compliant	
PET+PC, UV rated	-40°C to +85°C	IP67	Yes	

Notes:

1. Storage Temperature: -40°C to 85°C
2. Measured on 305mm (12") SQ ground plane
3. LPT600/71DMN comes in black, for white add the suffix W and PN becomes LPT600/71DMNW
4. Ø15.9mm (0.625") mounting hole required.

Outdoor 5G/4G Direct Mount Salt Shaker Monopole Antenna

LPT600/71DMN and LPT600/71DMNW – 617 to 7125 MHz

Mechanical Drawing

LPT600/71DMN (W)

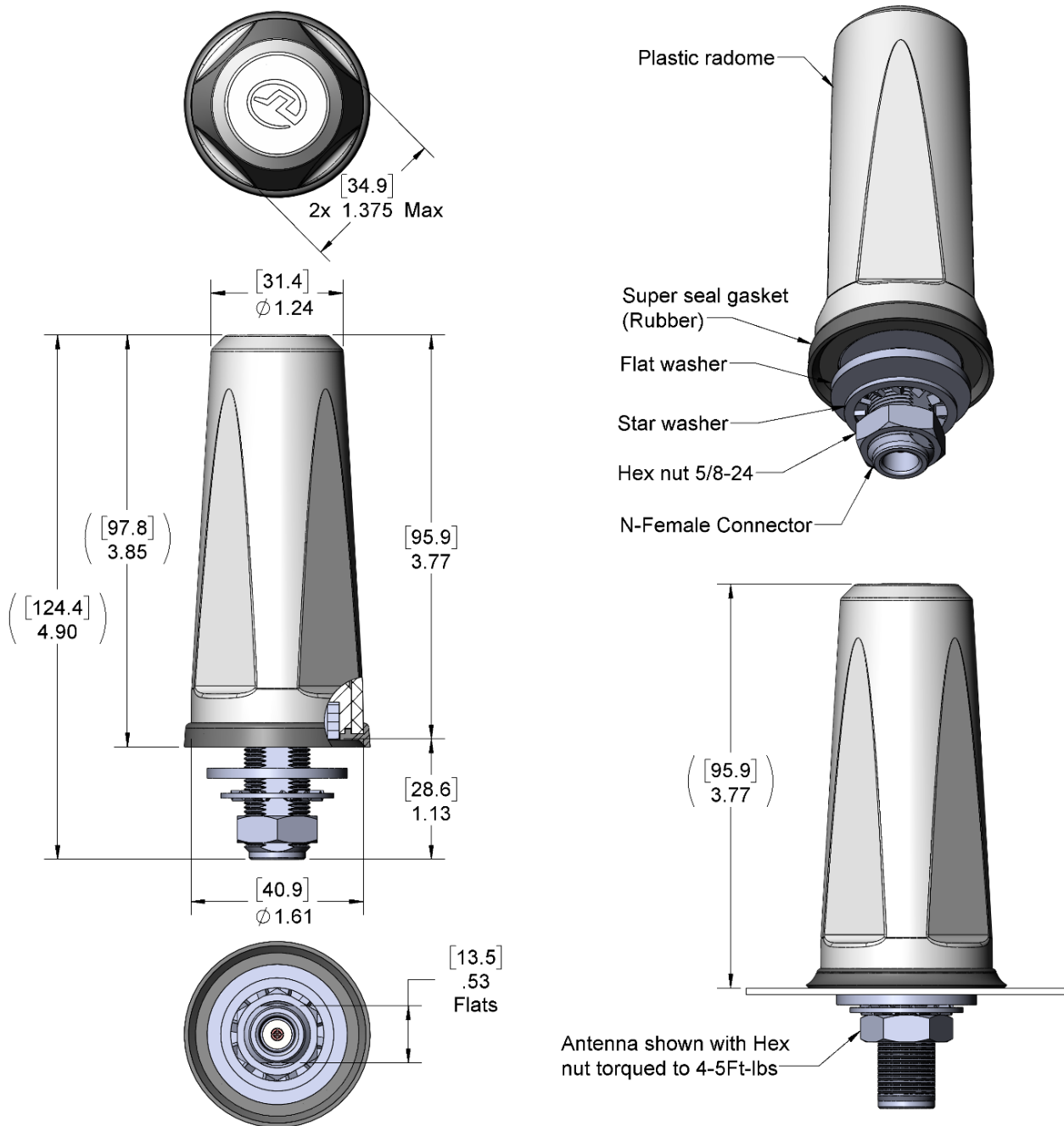

Dimensions: Inches (mm)

Unless otherwise specified, all tolerances are ± 0.010 (0.25mm)

Test Setup

LPT600/71DMN (W)

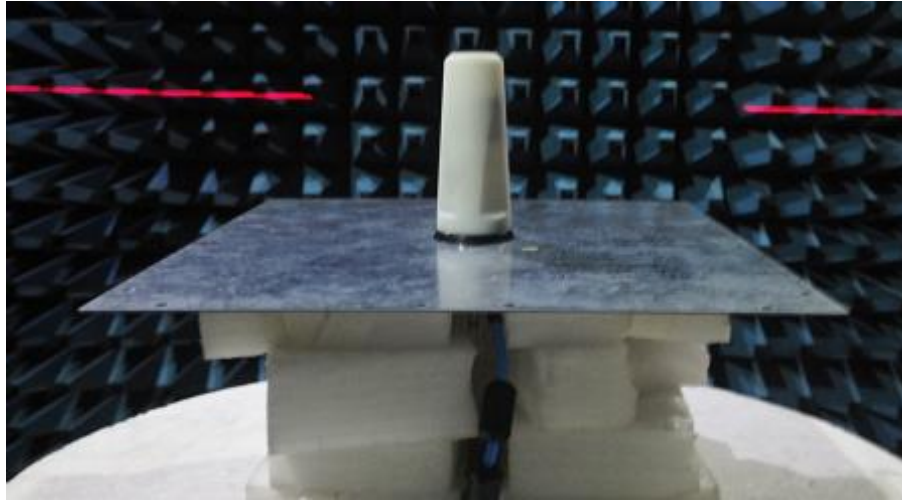

LPT600/71DMN antenna sample measured on 12" (305mm) SQ ground plane.

Charts- VSWR

LPT600/71DMN (W)

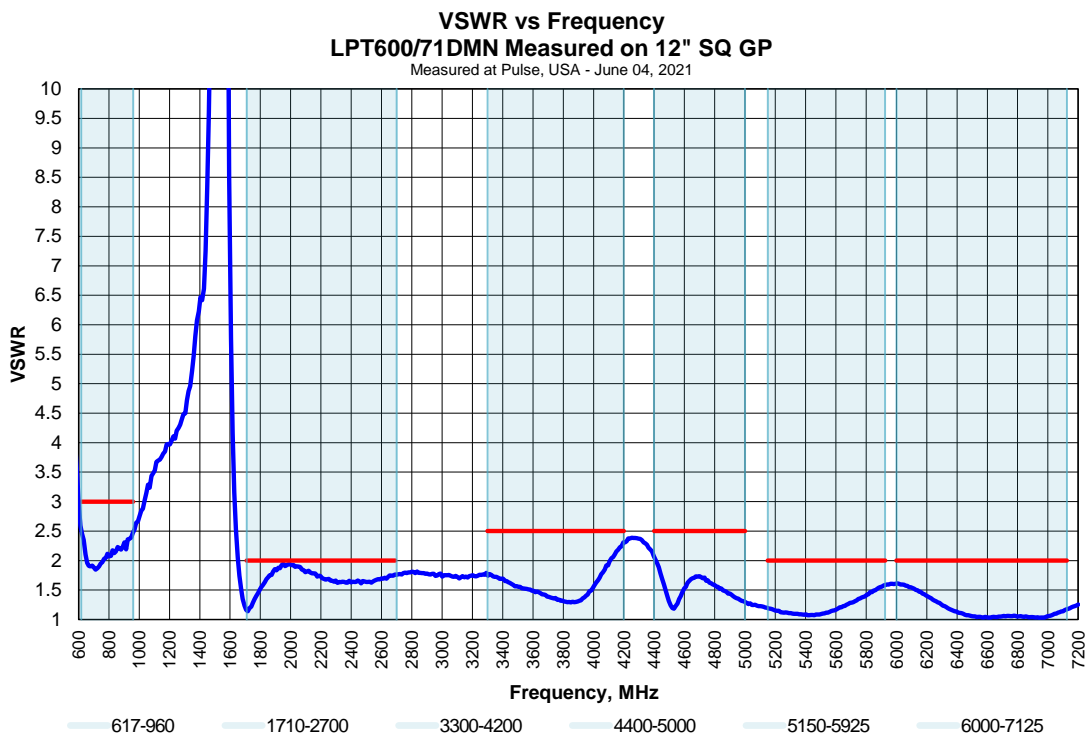

Charts- Peak Gain and Efficiency

LPT600/71DMN (W)

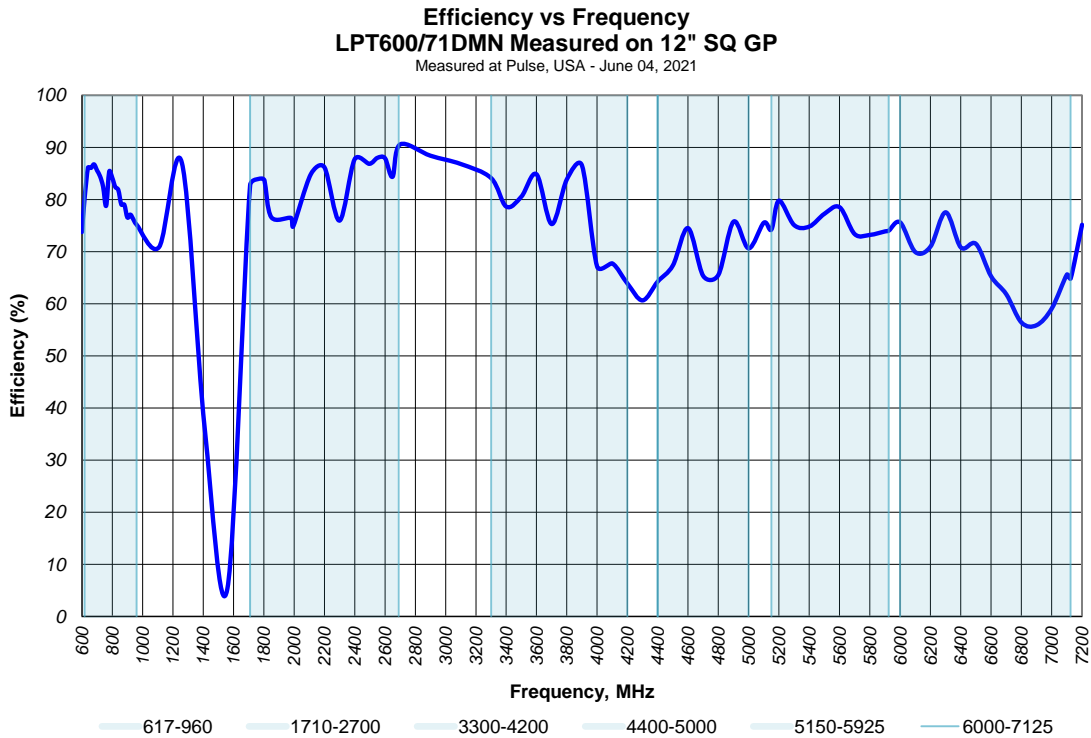
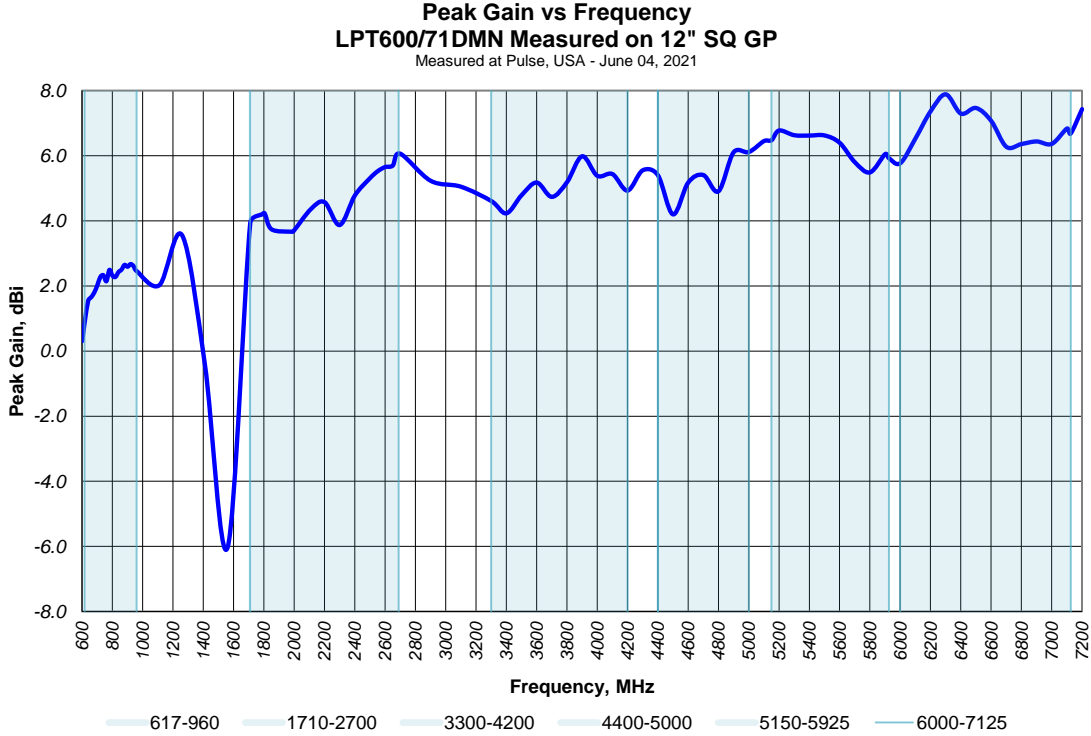

Charts- XY Gain Plots

LPT600/71DMN (W)

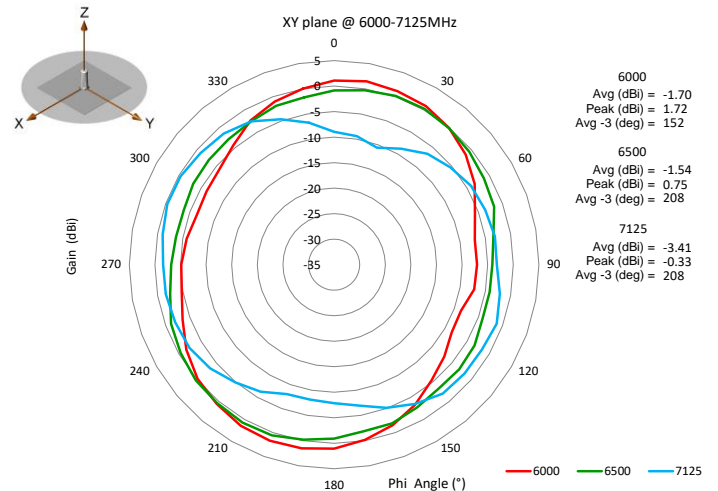
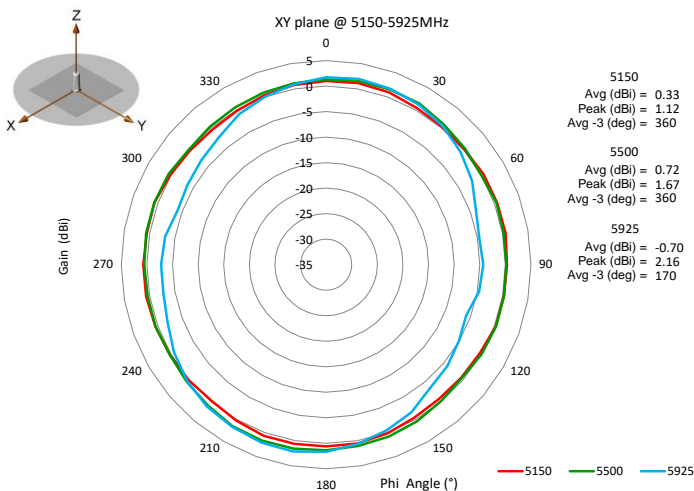
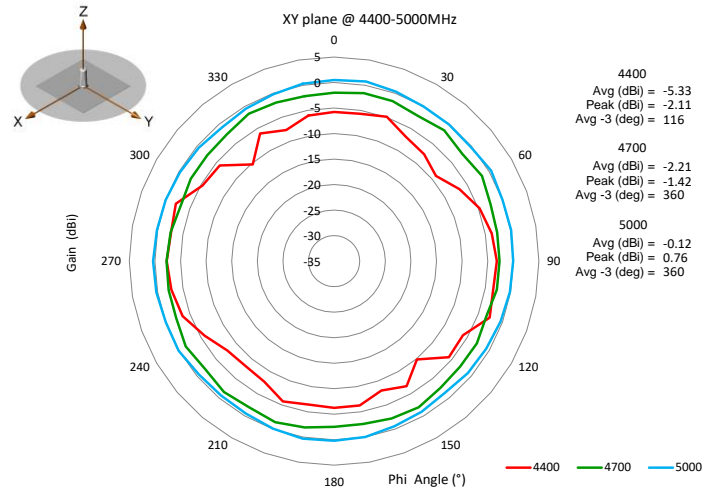
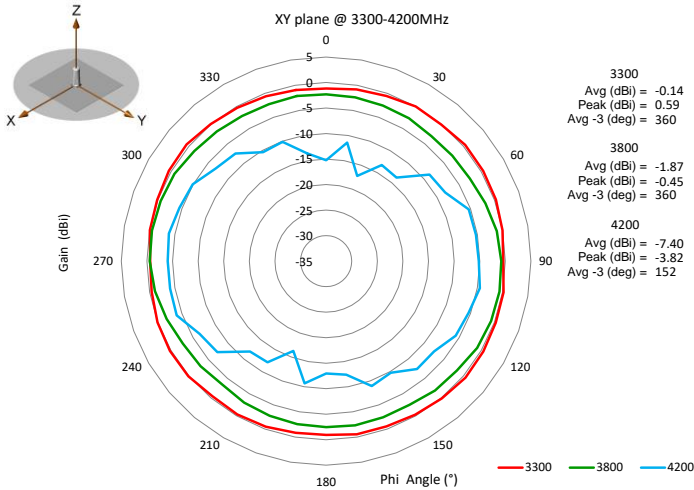
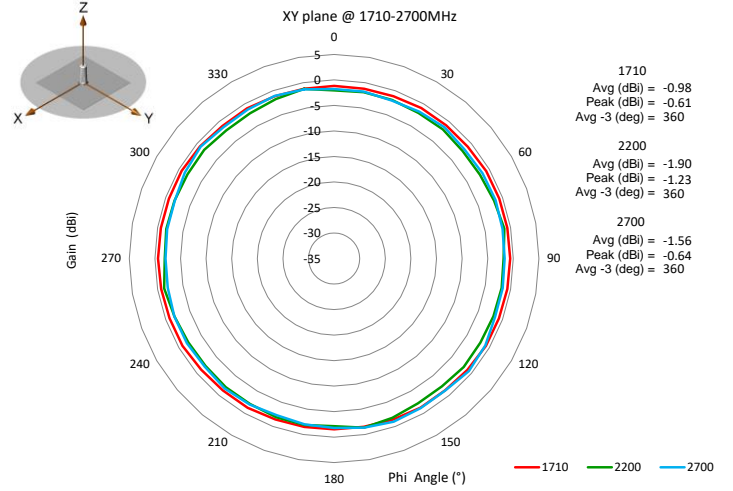
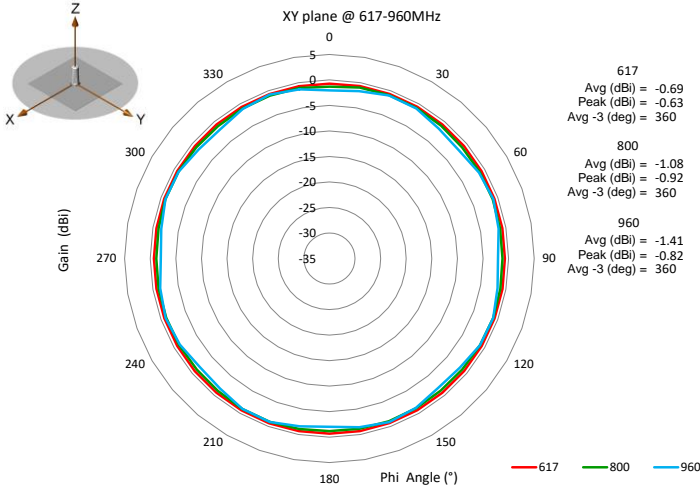

Charts – XZ Gain Plots

LPT600/71DMN (W)

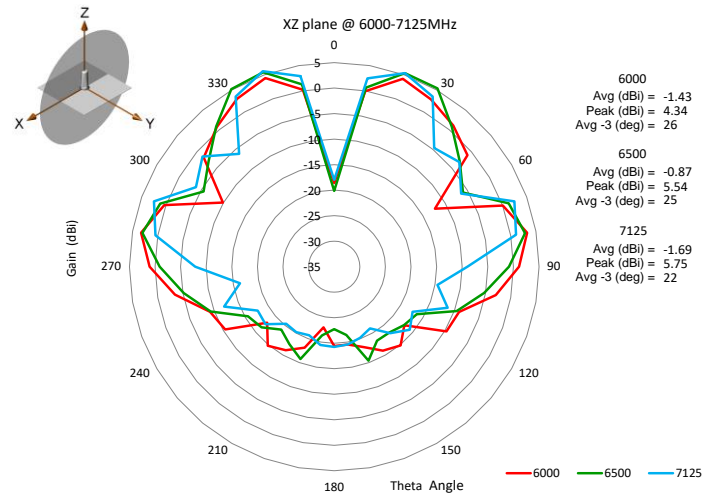
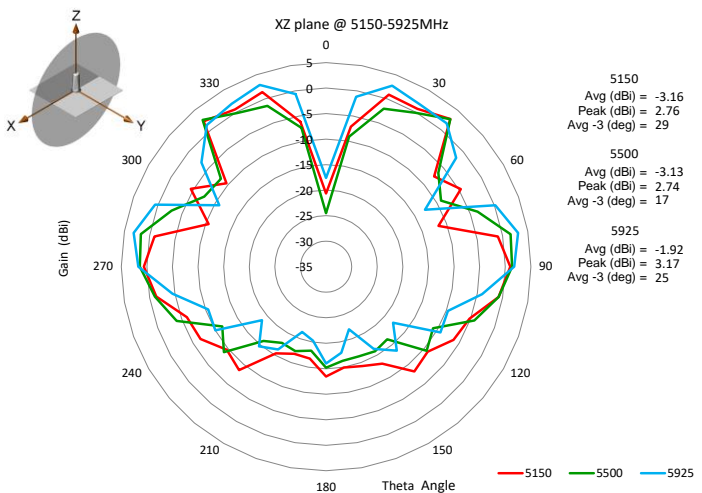
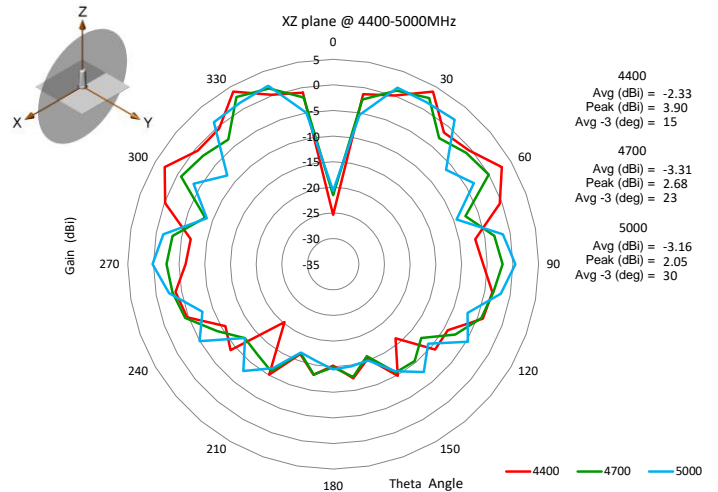
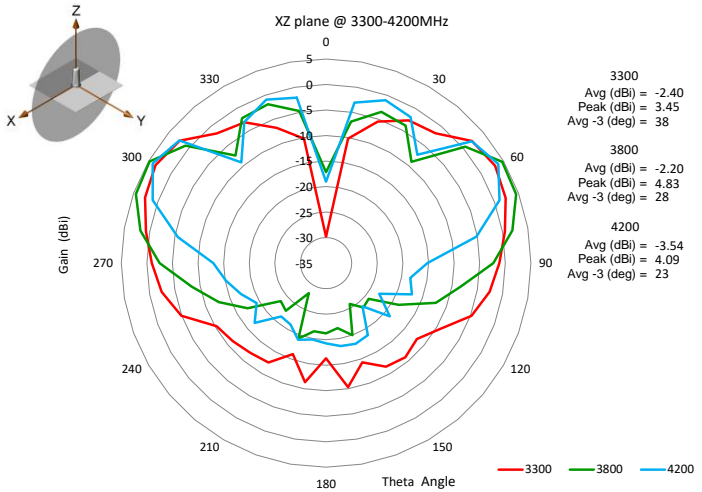
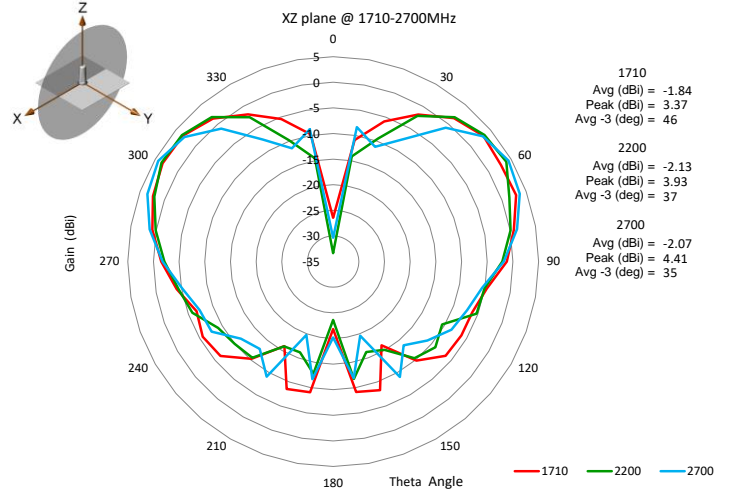
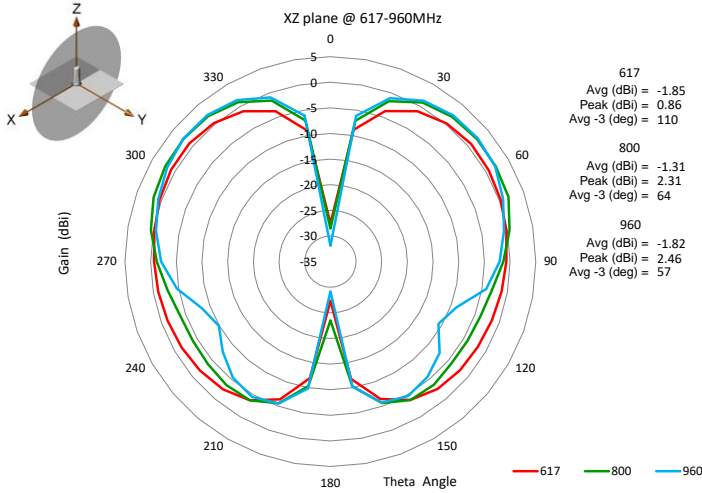

Outdoor 5G/4G Direct Mount Salt Shaker Monopole Antenna

LPT600/71DMN and LPT600/71DMNW – 617 to 7125 MHz

Packaging

LPT600/71DMN (W)

Packaging info:

1 antenna packed in a plastic bag.

1 label on each plastic bag with part number, description, date code.

Additional Product Info

LPT600/71DMN (W)

Family Products – LPT (Low Profile Transit)

5G / 4G LPT Products

Orderable PN	Connector Type	DC Ground (DCG)	Color
LPT600/71DMN (or LPT600/71DMNW)	N-Female	No	Black (or White)
LPTDCG600/71DMN (or LPTDCG600/71DMNW)	N-Female	Yes	Black (or White)
LPTNGP600/71DMN (or LPTNGP600/71DMNW) ¹	N-Female	No	Black (or White)
LPTNGPDCG600/71DMN (or LPTNGPDCG600/71DMNW) ¹	N-Female	Yes	Black (or White)
LPT600/71NM (or LPT600/71NMW)	N-Male	No	Black (or White)
LPTDCG600/71NM (or LPTDCG600/71NMW)	N-Male	Yes	Black (or White)
LPT600/71NMO (or LPT600/71NMOW)	NMO-Pogo	No	Black (or White)
LPTDCG600/71NMO (or LPTDCG600/71NMOW)	NMO-Pogo	Yes	Black (or White)

Notes:

1. 'NGP' stands for 'No Ground Plane'. LPTNGP600/71DMN or LPTNGP600/71DMNW is a ground independent antenna. Antenna was tuned without a ground plane.
2. Please contact sales for availability, lead time, and/or any special requests. Samples available upon request.

For More Information:

Americas - antennas.us@pulseelectronics.com | Europe – antennas.eu@pulseelectronics.com | Asia – antennas.as@pulseelectronics.com | Questions? +1-800-ANTENNA
Performance warranty of products offered on this data sheet is limited to the parameters specified. Data is subject to change without notice. Other brand and product names mentioned herein may be trademarks or registered trademarks of their respective owners. © Copyright , 2020. Pulse Electronics, Inc. All rights reserved.

X-ON Electronics

Largest Supplier of Electrical and Electronic Components

Click to view similar products for [Antennas](#) category:

Click to view products by [Pulse](#) manufacturer:

Other Similar products are found below :

[GAN30084EU](#) [930-033-R](#) [GW17.07.0250E](#) [1513563-1](#) [EXE902SM](#) [APAMPG-117](#) [MAF94383](#) [W3908B0100](#) [W6102B0100](#) [YE572113-30RSMM](#) [108-00014-50](#) [66089-2406](#) [SPDA17RP918](#) [A09-F8NF-M](#) [A09-F5NF-M](#) [RGFRA1903041A1T](#) [W3593B0100](#) [W3921B0100](#) [SIMNA-868](#) [SIMNA-915](#) [SIMNA-433](#) [W1044](#) [W1049B090](#) [A75-001](#) [WTL2449CQ1-FRSMM](#) [CPL9C](#) [EXB148BN](#) [0600-00060](#) [TRA9020S3PBN-001](#) [Y4503](#) [GD5W-28P-NF](#) [MA9-7N](#) [GD53-25](#) [GD5W-21P-NF](#) [C37](#) [MAF94051](#) [MA9-5N](#) [EXD420PL](#) [B1322NR](#) [QWFTB120](#) [MAF94271](#) [MAF94300](#) [GPSMB301](#) [FG4403](#) [AO-AGSM-OM54](#) [5200232](#) [MIKROE-2349](#) [WCM.01.0111](#) [MIKROE-2393](#) [MIKROE-2352](#)