





SMT Current Sense Transformers

PA1005.XXXNL and PM2165.XXXNL



-  **Height:** 5.5mm Max
-  **Footprint:** 8.4mm x 7.2mm Max
-  **Current Rating:** up to 20A
-  **Frequency Range:** 20kHz to 1MHz
-  **Low Primary DCR version of P820X**

Electrical Specifications @ 25°C — Operating Temperature -40°C to +130°C

Part Number		Turns Ratio	Current Rating ² (A)	Secondary Inductance (mH MIN)	DCR (mΩ MAX)		Hipot (V _{RMS})
Commerical	Automotive ⁷				Primary (8-7)	Secondary (1-3)	
PA1005.020NL	PM2165.020NL	1:20	20	0.08	0.75	550	1000
PA1005.030NL	PM2165.030NL	1:30	20	0.18	0.75	870	1000
PA1005.040NL	PM2165.040NL	1:40	20	0.32	0.75	1140	1000
PA1005.050NL	PM2165.050NL	1:50	20	0.5	0.75	1500	1000
PA1005.060NL	PM2165.060NL	1:60	20	0.72	0.75	2250	1000
PA1005.070NL	PM2165.070NL	1:70	20	0.98	0.75	4750	1000
PA1005.100NL	PM2165.100NL	1:100	20	2.00	0.75	5500	1000
PA1005.125NL	PM2165.125NL	1:125	20	3.00	0.75	6500	500

Notes:

- The temperature of component (ambient temperature plus temperature rise) must be within the specified operating temperature range.
- The maximum current rating is based upon temperature rise of the component and represents the DC current which will cause a typical temperature rise of 40°C with no airflow.
- To calculate value of terminating resistor (Rt) use the following formula:

$$R_t (W) = V_{ref} * N / (I_{peak_primary})$$
- The peak flux density of the device must remain below 2000 Gauss. To calculate the peak flux density for uni-polar current use following formula:

$$B_{pk} = 37.59 * V_{ref} * (Duty_Cycle_Max) * 10^5 / (N * Freq_kHz)$$
 * for bi-polar current applications divide Bpk (as calculated above) by 2.
- Optional Tape & Reel packaging can be ordered by adding a "T" suffix to the part number (i.e. PA1005.020NL becomes PA1005.020NLT). Pulse complies to industry standard tape and reel specification EIA481.
- The "NL" suffix indicates an RoHS-compliant part number. Non-NL suffixed parts are not necessarily RoHS compliant, but are electrically and mechanically equivalent to NL versions. If a part number does not have the "NL" suffix, but an RoHS compliant version is required, please contact Pulse for availability.
- The PM2165.XXXNL part numbers are AEC-Q200 and IATF16949 certified. The mechanical dimensions are 100% tested in production but do not necessarily meet a product capability index (Cpk) >1.33 and therefore may not strictly conform to PPAP.

SMT Current Sense Transformers

PA1005.XXXNL and PM2165.XXXNL

Mechanical

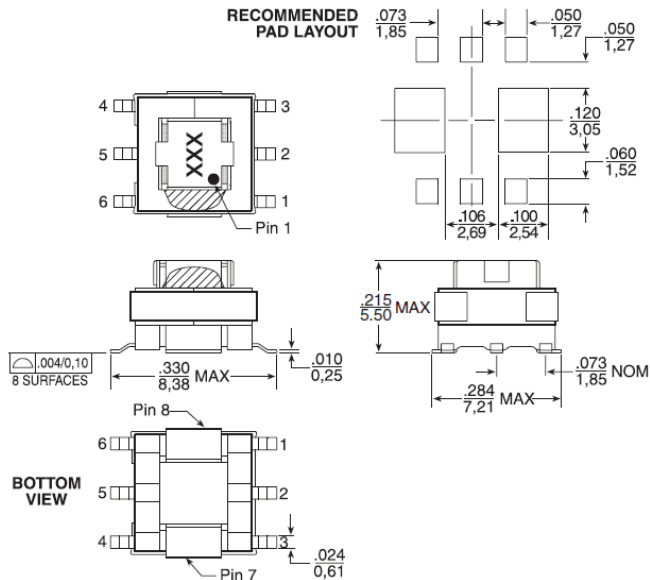

Schematic

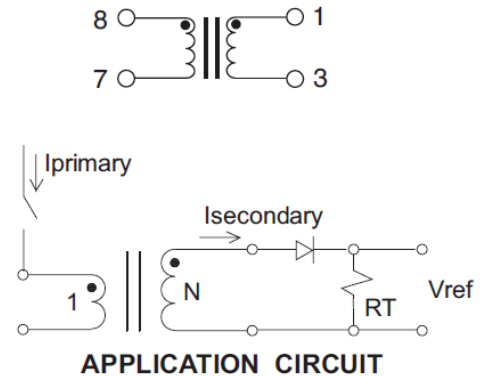

Weight0.34grams **Dimensions:** Inches
 Tape & Reel900/reel Unless otherwise specified, mm
 Tray120/tray all tolerances are: ± ^{0.10}/_{0.25}

TAPE & REEL INFO

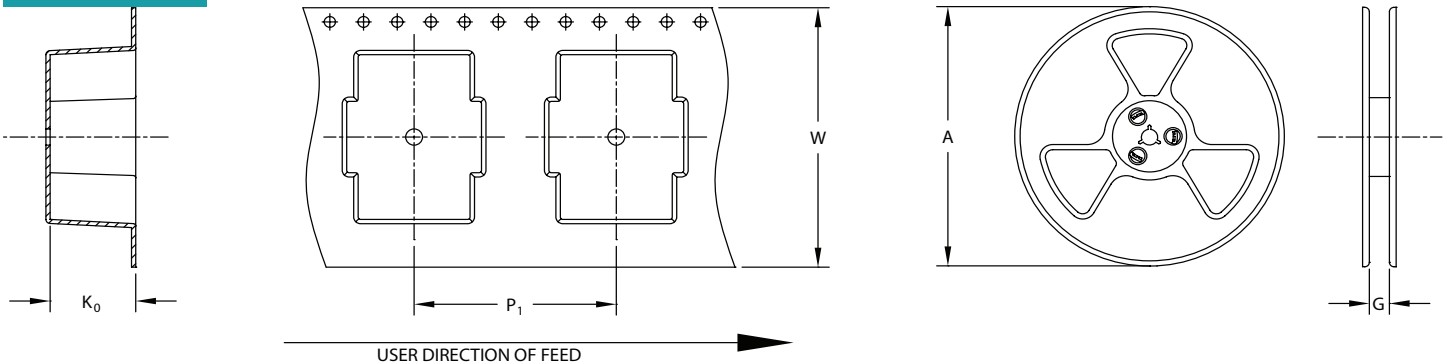

SURFACE MOUNTING TYPE, REEL/TAPE LIST

PART NUMBER	REEL SIZE (mm)		TAPE SIZE (mm)			QTY
	A	G	P ₁	W	K ₀	PCS/REEL
PA1005.XXXNL/PM2165.XXXNL	Ø330	16.4	12	16	5.65	900

For More Information

Pulse Worldwide Headquarters

15255 Innovation Drive Ste 100
 San Diego, CA 92128
 U.S.A.

Pulse Europe

Pulse Electronics GmbH
 Am Rottland 12
 58540 Meinerzhagen
 Germany

Pulse China Headquarters

Pulse Electronics (ShenZhen) CO., LTD
 D708, Shenzhen Academy of
 Aerospace Technology,
 The 10th Keji South Road,
 Nanshan District, Shenzhen,
 P.R. China 518057

Pulse North China

Room 2704/2705
 Super Ocean Finance Ctr.
 2067 Yan An Road West
 Shanghai 200336
 China

Pulse South Asia

3 Fraser Street 0428
 DUO Tower
 Singapore 189352

Pulse North Asia

1F., No.111 Xiyuan Road
 Zhongli District
 Taoyuan City 32057
 Taiwan (R.O.C)

Tel: 858 674 8100
 Fax: 858 674 8262

Tel: 49 2354 777 100
 Fax: 49 2354 777 168

Tel: 86 755 33966678
 Fax: 86 755 33966700

Tel: 86 21 62787060
 Fax: 86 2162786973

Tel: 65 6287 8998
 Fax: 65 6280 0080

Tel: 886 3 4356768
 Fax: 886 3 4356820

Performance warranty of products offered on this data sheet is limited to the parameters specified. Data is subject to change without notice. Other brand and product names mentioned herein may be trademarks or registered trademarks of their respective owners. © Copyright, 2019. Pulse Electronics, Inc. All rights reserved.

X-ON Electronics

Largest Supplier of Electrical and Electronic Components

Click to view similar products for [Current Transformers](#) category:

Click to view products by [Pulse manufacturer](#):

Other Similar products are found below :

[L595100](#) [ACST-260](#) [MP3500](#) [L595050](#) [BV EI 304 2089](#) [PACT RCP-4000A-UIRO-PT-D14](#) [PACT RCP-4000A-UIRO-PT-D19](#) [E54CT1L](#)
[CTD-KIT](#) [44021](#) [44104](#) [44176](#) [44248](#) [45023](#) [45041](#) [45071](#) [PA3828NL](#) [CT16-1-50A/50MA](#) [SPCT 100/60 1200/5A VA 15 CL 0.5](#) [SPCT](#)
[100/60 1000/5A VA 15 CL 0.5](#) [SPCT 100/60 600/5 A VA 7.5 CL 1](#) [SPCT 100/60 600/5 A VA 5 CL 0.5](#) [SPCT 100/60 800/5 A VA 10 CL 0.5](#)
[SPCT 140/100 1200/5A VA 15 CL 0.5](#) [SPCT 140/100 1250/5A VA 15 CL 0.5](#) [SPCT 140/100 1500/5A VA 15 CL 0.5](#) [SPCT 140/100 1600/5A](#)
[VA 15 CL 0.5](#) [SPCT 140/100 1000/5A VA 15 CL 0.5](#) [SPCT 140/100 2500/5A VA 15 CL 0.5](#) [SPCT 140/100 2000/5A VA 15 CL 0.5](#) [SPCT](#)
[140/100 3000/5A VA 15 CL 0.5](#) [SPCT 140/100 800/5A VA 15 CL 0.5](#) [SPCT 62/30 50/5A VA1 CL 3](#) [SPCT 62/30 60/5A VA1 CL 3](#) [SPCT](#)
[62/30 75/5A VA1 CL 3](#) [SPCT 62/30 75/5A VA3 CL 3](#) [SPCT 62/40 100/5 A VA 1 CL 1](#) [SPCT 62/40 125/5 A VA 1 CL 1](#) [SPCT 62/40 150/5 A](#)
[VA 3 CL 1](#) [SPCT 62/40 160/5 A VA 1.5 CL 1](#) [SPCT 62/40 200/5 A VA 2,5 CL 0,5](#) [SPCT 62/40 200/5 A VA 3 CL 1](#) [SPCT 62/40 250/5 A VA](#)
[3 CL 1](#) [SPCT 62/40 300/5 A VA 3 CL 0.5](#) [SPCT 62/40 400/5 A VA 3.75 CL 0.5](#) [2CSM029000R1211](#) [HPT205NBJ-1](#) [HCT204KFH](#) [HCT20K-](#)
[QD](#) [HPT205A/F](#)