

THT Common Mode Chokes

PA3747.XXXNL

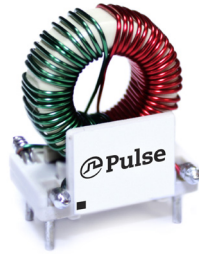

Dielectric Strength: 1500Vrms
Inductance Range: 0.67mH (at 5A) to 19.5mH (at 0.75A)
Height: 22.9mm Max
Footprint: 19.3mm x 18.2mm

Electrical Specifications @ 25°C - Operating Temperature -40°C to +125°C

Part Number	Inductance (1-2)=(3-4) (mH Min)	Current Rating ¹ (1-2)=(3-4) (A)	DCR (1-2)=(3-4) (mΩ Max)	Self Resonant Frequency (1-2)=(3-4) (MHz Min)	Impedance (kΩms Min at SRF)
PA3747.105NL	0.67	5.00	16	1.18	3.33
PA3747.205NL	1.28	4.00	25.5	1.10	5.04
PA3747.305NL	1.92	2.75	49.5	1.00	5.08
PA3747.405NL	2.68	2.25	71.5	0.94	11.57
PA3747.505NL	3.33	1.85	103.5	0.88	14.40
PA3747.605NL	4.06	1.55	132	0.78	17.93
PA3747.705NL	4.58	1.50	134	0.80	18.24
PA3747.905NL	6.03	1.45	154	0.30	24.38
PA3747.106NL	6.67	1.40	169	0.29	26.90
PA3747.146NL	9.10	1.00	207	0.21	42.69
PA3747.206NL	13.00	1.00	295	0.20	51.22
PA3747.306NL	19.50	0.75	572	0.12	80.65

- Notes:**
1. The current rating (Irated) is based upon the temperature rise of the component and represents the rms current which will cause a typical temperature rise of 40 °C.
 2. The temperature of the component (ambient plus temperature rise) must be within the stated operating temperature range.

Mechanical

Schematic

PA3747.XXXNL

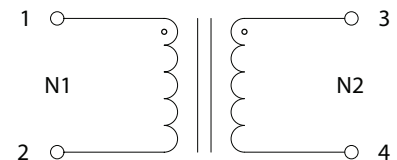
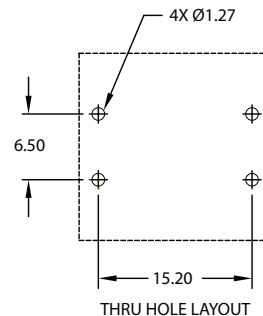
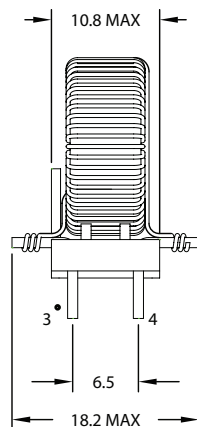
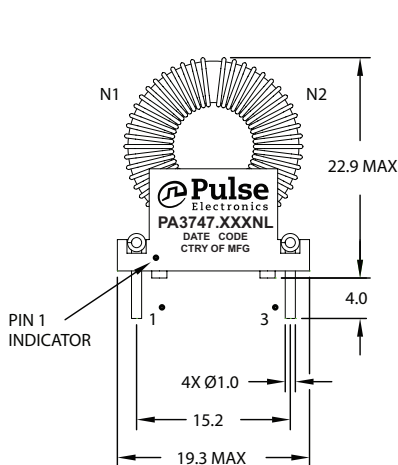

THT Common Mode Chokes

PA3747.XXXNL

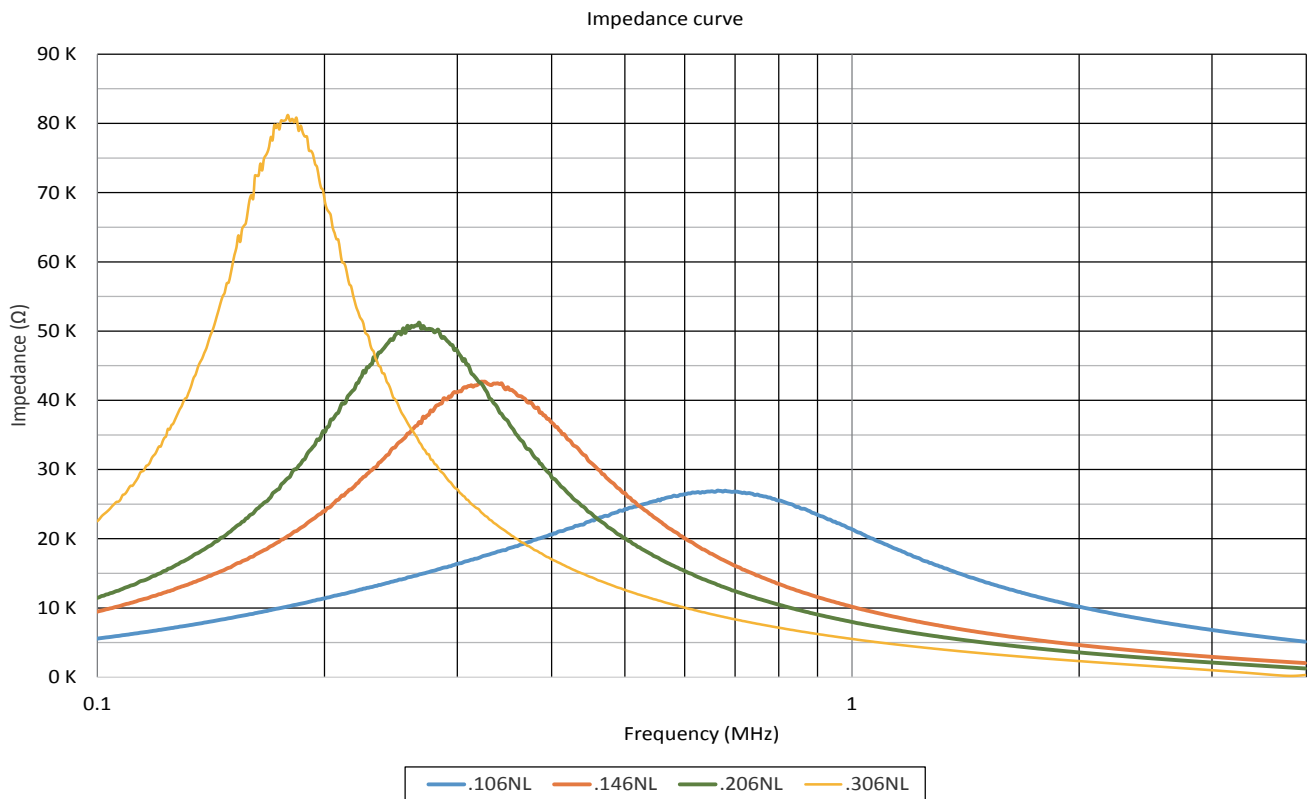
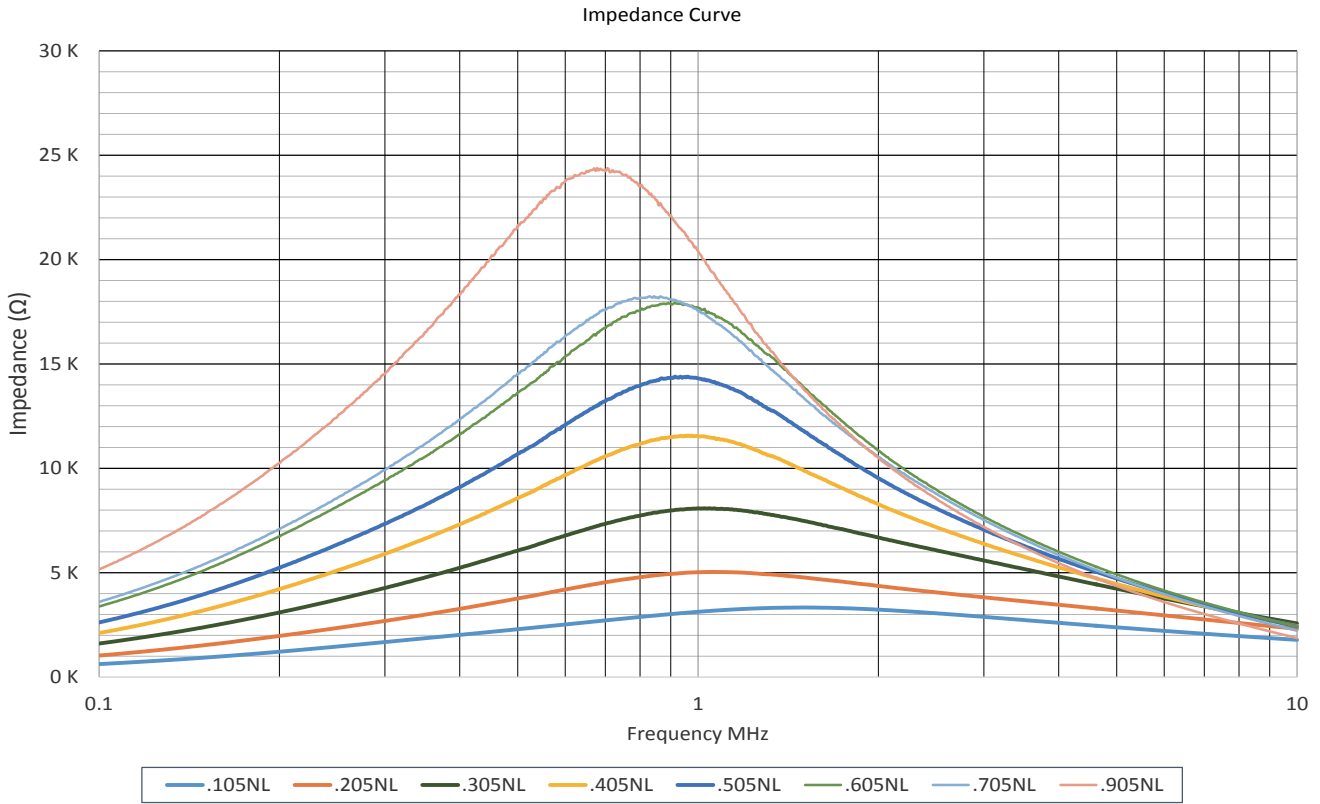

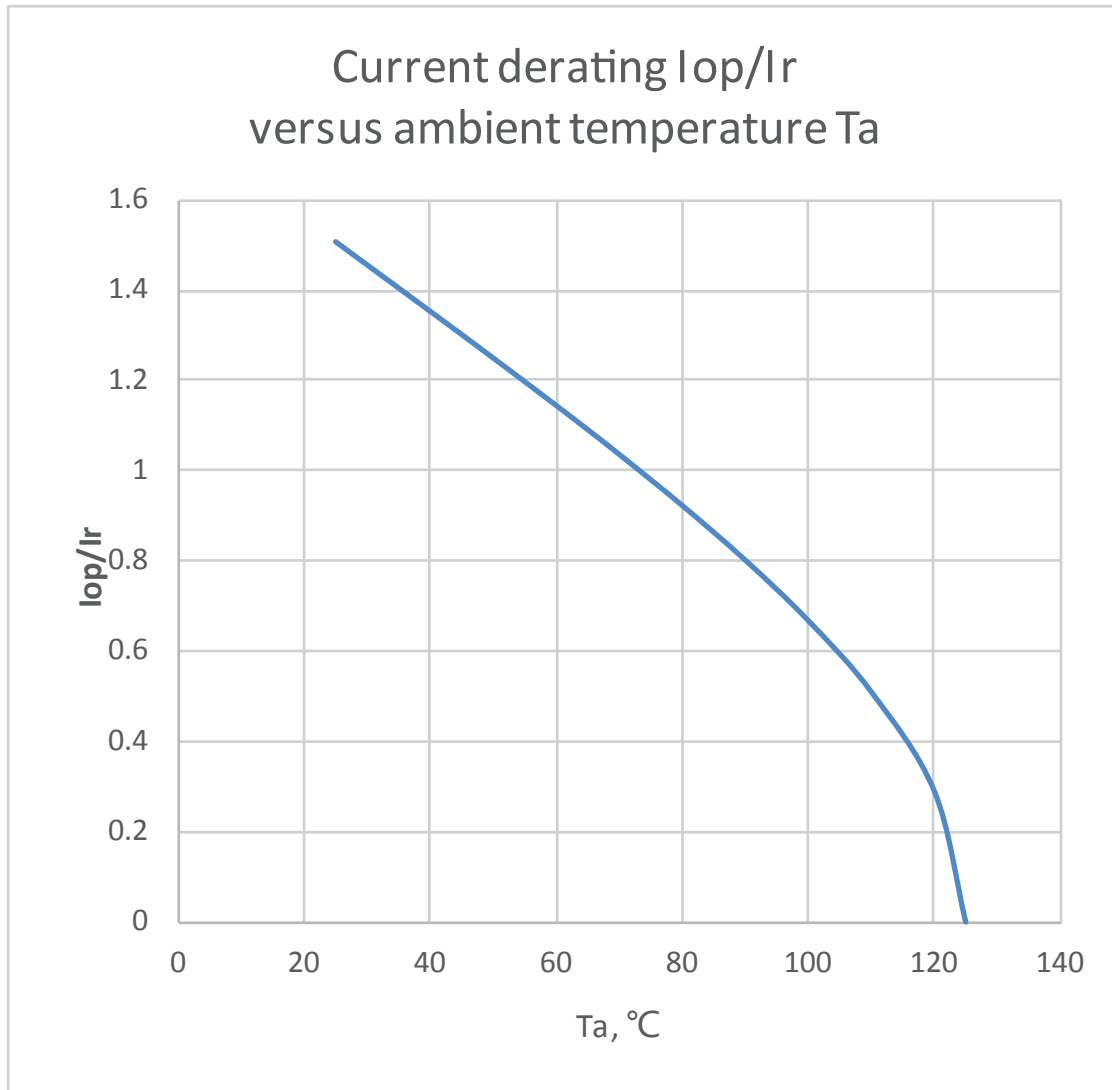

For More Information

Pulse Worldwide Headquarters

15255 Innovation Drive Ste 100
San Diego, CA 92128
U.S.A.

Pulse Europe

Pulse Electronics GmbH
Am Rottland 12
58540 Meinerzhagen
Germany

Pulse China Headquarters

Pulse Electronics (Shenzhen) CO., LTD
D708, Shenzhen Academy of
Aerospace Technology,
The 10th Keji South Road,
Nanshan District, Shenzhen,
P.R. China 518057

Pulse North China

Room 2704/2705
Super Ocean Finance Ctr.
2067 Yan An Road West
Shanghai 200336
China

Pulse South Asia

3 Fraser Street
0428 DUO Tower
Singapore 189352

Pulse North Asia

1F., No.111 Xiyuan Rd
Zhongli City
Taoyuan City 32057
Taiwan (R.O.C)

Tel: 858 674 8100
Fax: 858 674 8262

Tel: 49 2354 777 100
Fax: 49 2354 777 168

Tel: 86 755 33966678
Fax: 86 755 33966700

Tel: 86 21 62787060
Fax: 86 2162786973

Tel: 65 6287 8998
Fax: 65 6280 0080

Tel: 886 3 4356768
Fax: 886 3 4356820

Performance warranty of products offered on this data sheet is limited to the parameters specified. Data is subject to change without notice. Other brand and product names mentioned herein may be trademarks or registered trademarks of their respective owners. © Copyright, 2020. Pulse Electronics, Inc. All rights reserved.

X-ON Electronics

Largest Supplier of Electrical and Electronic Components

Click to view similar products for [Audio Transformers](#) / [Signal Transformers](#) category:

Click to view products by [Pulse manufacturer](#):

Other Similar products are found below :

[749023020](#) [CU4S0506AT-2655-H1](#) [MET-58](#) [PE-64961](#) [H5008FNL](#) [H5020FNLT](#) [H5079NLT](#) [1879479-1](#) [1879564-1](#) [PA1277NLT](#)
[PA1528ANL](#) [PA2007NLT](#) [FL1066](#) [T1137NLT](#) [T3012NL](#) [PE-65812FNL](#) [TTC-100](#) [TTC-143-H](#) [TTC-5032-1](#) [HX1234NLT](#) [HX5008FNLT](#)
[100B-1001XNL](#) [PA1282NLT](#) [HX5084FNL](#) [T1108NLT](#) [2-1879391-5](#) [TTC-266-2](#) [3-1879385-4](#) [PA1032NL](#) [H2009FNLT](#) [PA0801NLT](#)
[TTC-266](#) [X-1619](#) [SM51295PEL](#) [T5008NLT](#) [PE-68517T](#) [HX1294NLT](#) [HX5084FNLT](#) [H5015FNLT](#) [H6080NLT](#) [CX2024NL](#) [HX1294FNLT](#)
[TX1473NLT](#) [PE-69011NLT](#) [CX2047LNLT](#) [CX2043LNLT](#) [DCT20EFD-U32S003](#) [H5120NLT](#) [H7137FNLT](#) [H1259NLT](#)