







# THT Integrated Common Mode and Differential Mode Choke

PA4040.XXXNL



-  Common Mode and Differential Mode Choke intergrated into a single component reducing overall losses and reducing footprint
-  Dielectric Strength: 1500Vrms
-  Common Mode Inductance: 4.5mH (1Arms) to 0.28mH (3.5Arms)
-  Differential Mode Inductance: 685uH (1.33Apk) to 55uH (4.6Apk)
-  Size (LxWxH): 31.0mm x 24.9mm x 16.5 mm Max
-  Safety Spacing: 3.0mm creepage and clearance between windings, 1.5mm between windings and core

## Electrical Specifications @ 25°C - Operating Temperature -40°C to +125°C

Pulse PN	Common Mode Inductance (mH Min) (1-2)=(4-3)	Differential Mode Inductance (uH Min) (1-4 with 2,3 shorted)	I <sub>rms</sub> (A)	I <sub>peak</sub> (A)	DCR/winding (mΩ Max) (1-2)=(4-3)	SRF (MHz, typical)	Impedance at SRF (kΩ typical)
PA4040.001NL	4.5	685	1.0	1.33	245	0.5	140
PA4040.002NL	1.25	320	1.5	2	120	0.7	47
PA4040.003NL	0.41	96	2.5	3.33	46	1.45	8.5
PA4040.004NL	0.28	55	3.5	4.6	32	1.75	5.3

- Notes:**
- The current rating (I<sub>rms</sub>) is based upon the temperature rise of the component and represents the rms current which will cause a typical temperature rise of 40°C.
  - The peak current is the current which will typically cause a 20% drop in the differential mode inductance. The peak current should not be exceeded in the application as it will reduce the CM and DM rejection of the component.
  - The temperature of the component (ambient plus temperature rise) must be within the stated operating temperature range.
  - The PA4040.XXXNL is designed to provide 3.0mm of safety spacing (creepage and clearance distance) between windings and 1.5mm of safety spacing (creepage and clearance distance) between both windings and core.

# THT Integrated Common Mode and Differential Mode Choke

PA4040.XXXNL

## Mechanical

PA4040.XXXNL

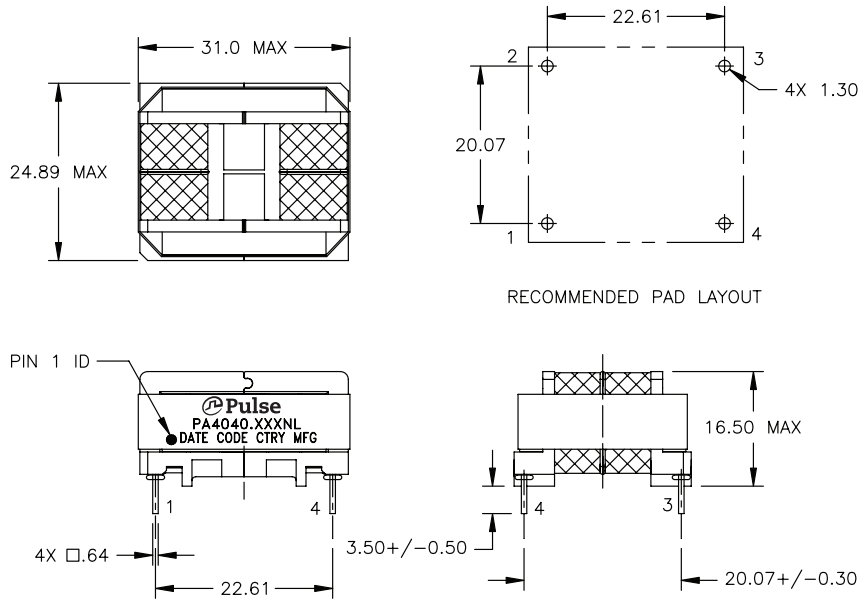

## Schematic

PA4040.XXXNL

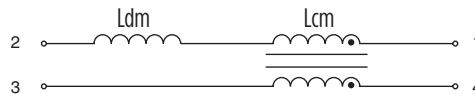

## For More Information

**Pulse Worldwide Headquarters**  
12220 World Trade Drive  
San Diego, CA  
92128  
U.S.A.

**Pulse Europe**  
Zeppelinstrasse 15  
71083 Herrenberg  
Germany

**Pulse China Headquarters**  
B402, Shenzhen Academy of  
Aerospace Technology Bldg.  
10th Kejian Road  
High-Tech Zone  
Nanshan District  
Shenzhen, PR China  
518057  
Tel: 86 755 33966678  
Fax: 86 755 33966700

**Pulse North China**  
Room 2704/2705  
Super Ocean Finance  
Ctr.  
2067 Yan An Road  
West  
Shanghai 200336  
China  
Tel: 86 21 62787060

**Pulse South Asia**  
135 Joo Seng Road  
#03-02  
PM Industrial Bldg.  
Singapore 368363  
Tel: 65 6287 8998  
Fax: 65 6287 8998

**Pulse North Asia**  
3F, No. 198  
Zhongyuan Road  
Zhongli City  
Taoyuan County 320  
Taiwan R. O. C.  
Tel: 886 3 4356768  
Fax: 886 3 4356823  
(Pulse)

Tel: 858 674 8100  
Fax: 858 674 8262

Tel: 49 7032 7806 0  
Fax: 49 7032 7806 12

Performance warranty of products offered on this data sheet is limited to the parameters specified. Data is subject to change without notice. Other brand and product names mentioned herein may be trademarks or registered trademarks of their respective owners. © Copyright, 2014. Pulse Electronics, Inc. All rights reserved.

## X-ON Electronics

Largest Supplier of Electrical and Electronic Components

*Click to view similar products for [Audio Transformers](#) / [Signal Transformers](#) category:*

*Click to view products by [Pulse manufacturer](#):*

Other Similar products are found below :

[749023020](#) [CU4S0506AT-2655-H1](#) [MET-58](#) [PE-64961](#) [H5008FNL](#) [H5020FNLT](#) [H5079NLT](#) [1879479-1](#) [1879564-1](#) [PA1277NLT](#)  
[PA1528ANL](#) [PA2007NLT](#) [FL1066](#) [T1137NLT](#) [T3012NL](#) [PE-65812FNL](#) [TTC-100](#) [TTC-143-H](#) [TTC-5032-1](#) [HX1234NLT](#) [HX5008FNLT](#)  
[100B-1001XNL](#) [PA1282NLT](#) [HX5084FNL](#) [T1108NLT](#) [2-1879391-5](#) [TTC-266-2](#) [3-1879385-4](#) [PA1032NL](#) [H2009FNLT](#) [PA0801NLT](#)  
[TTC-266](#) [X-1619](#) [SM51295PEL](#) [T5008NLT](#) [PE-68517T](#) [HX1294NLT](#) [HX5084FNLT](#) [H5015FNLT](#) [H6080NLT](#) [CX2024NL](#) [HX1294FNLT](#)  
[TX1473NLT](#) [PE-69011NLT](#) [CX2047LNLT](#) [CX2043LNLT](#) [DCT20EFD-U32S003](#) [H5120NLT](#) [H7137FNLT](#) [H1259NLT](#)