





# SMT Power Inductor

Shielded Drum Core - PA4334.XXXNLT Series



-  **Height:** 1.2mm Max
-  **Footprint:** 3.2mm x 3.2mm Max
-  **Current Rating:** up to 3.0A
-  **Inductance Range:** 0.22uH to 100uH
-  Shielded magnetic circuit reduces leakage flux, Fe base metal core enables high saturation and metalized core termination results in excellent shock resistance.

Electrical Specifications @ 25°C - Operating Temperature -40°C to +125°C

Part Number	Inductance 1MHz, 1V  uH	Rated Current  A	Min. Self-Resonant Frequency  MHz	DC Resistance		Saturation Current (20°C)  A	Heating Current  A
				MAX.	TYP.		
				mΩ	mΩ		Δ T ≈ 40°C
PA4334.221NLT	0.22 ± 30%	3.00	328	22	17	5.30	3.00
PA4334.821NLT	0.82 ± 30%	2.05	107	39	30	2.05	2.47
PA4334.102NLT	1.0 ± 30%	1.87	89	52	40	1.87	2.20
PA4334.122NLT	1.2 ± 30%	2.01	83	59	45	2.22	2.01
PA4334.152NLT	1.5 ± 30%	1.62	71	59	45	1.62	2.01
PA4334.182NLT	1.8 ± 30%	1.30	65	82	63	1.30	1.65
PA4334.222NLT	2.2 ± 30%	1.20	55	98	75	1.20	1.55
PA4334.242NLT	2.4 ± 30%	1.15	47	88	68	1.15	1.60
PA4334.272NLT	2.7 ± 20%	1.14	54	110	85	1.14	1.48
PA4334.332NLT	3.3 ± 20%	1.05	46	130	100	1.05	1.36
PA4334.362NLT	3.6 ± 20%	1.05	36	130	100	1.05	1.36
PA4334.392NLT	3.9 ± 20%	1.00	53	189	145	1.00	1.24
PA4334.472NLT	4.7 ± 20%	0.90	31	156	120	0.90	1.24
PA4334.682NLT	6.8 ± 20%	0.75	30	247	190	0.75	0.98
PA4334.103NLT	10 ± 20%	0.60	23	345	265	0.60	0.83
PA4334.123NLT	12 ± 20%	0.48	20	449	345	0.48	0.73
PA4334.153NLT	15 ± 20%	0.45	22	468	360	0.45	0.71
PA4334.183NLT	18 ± 20%	0.43	16	709	545	0.43	0.58
PA4334.223NLT	22 ± 20%	0.42	22	839	645	0.42	0.53
PA4334.273NLT	27 ± 20%	0.35	12	1131	870	0.35	0.47

USA 858 674 8100

Germany 49 2354 777 100

Singapore 65 6287 8998

Shanghai 86 21 62787060

China 86 755 33966678

Taiwan 886 3 4356768

# SMT Power Inductor

Shielded Drum Core - PA4334.XXXNLT Series



## Electrical Specifications @ 25°C - Operating Temperature -40°C to +125°C

Part Number	Inductance 1MHz, 1V  uH	Rated Current  A	Min. Self-Resonant Frequency  MHz	DC Resistance		Saturation Current (20°C)  A	Heating Current  $\Delta T \approx 40^\circ C$
				MAX.	TYP.		
				mΩ	mΩ		A
PA4334.333NLT	33 ± 20%	0.36	12	1138	875	0.36	0.46
PA4334.363NLT	36 ± 20%	0.34	10	1235	950	0.34	0.44
PA4334.393NLT	39 ± 20%	0.37	10	1729	1330	0.30	0.37
PA4334.473NLT	47 ± 20%	0.27	11	1885	1450	0.27	0.35
PA4334.563NLT	56 ± 20%	0.26	9	1794	1380	0.26	0.28
PA4334.683NLT	68 ± 20%	0.24	7	2171	1670	0.24	0.33
PA4334.823NLT	82 ± 20%	0.17	7	3302	2540	0.17	0.27
PA4334.104NLT	100 ± 20%	0.21	5	3718	2860	0.21	0.25

### Notes:

- Actual temperature of the component during system operation (ambient plus temperature rise) must be within the standard operating range.
- The rated current as listed is either the saturation current (@ 20°C) or the heating current ( $\Delta T \approx 40^\circ C$ ) depending on which value is lower.
- The saturation current is the current at which the initial inductance drops approximately 30% at the stated ambient temperature. This current is determined by placing the component in the specified ambient environment and applying a short duration pulse current (to eliminate self-heating effect) to the component.
- The heating current is the DC current required to raise the component temperature by approximately 40°C. Take note that the components' performance varies depending on the system condition. It is suggested that the component be tested at the system level, to verify the temperature rise of the component during system operation.
- Maximum voltage across terminals to be limited to <40Vdc

## Mechanical

### PA4334.XXXNLT

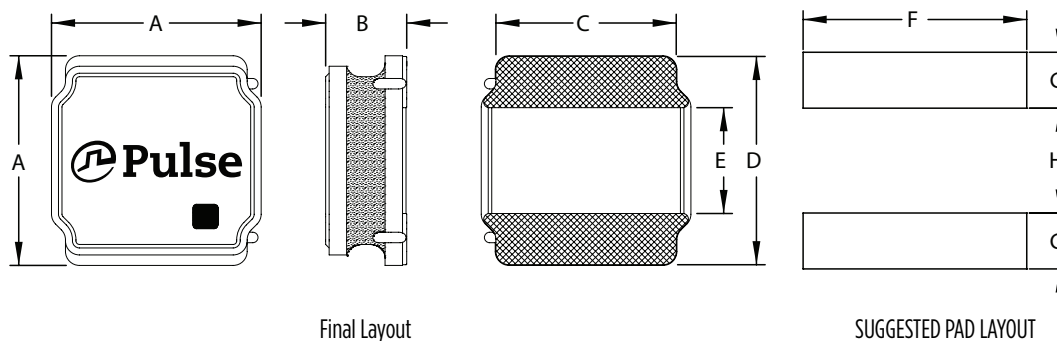

Series	A	B	C	D	E	F	G	H
PA4334.XXXNLT	3.2 MAX	1.2 MAX	(2.5)	(3.0)	(1.5)	(2.7)	(0.8)	(1.5)

All Dimensions in mm.

# SMT Power Inductor

Shielded Drum Core - PA4334.XXXNLT Series

## TAPE & REEL INFO

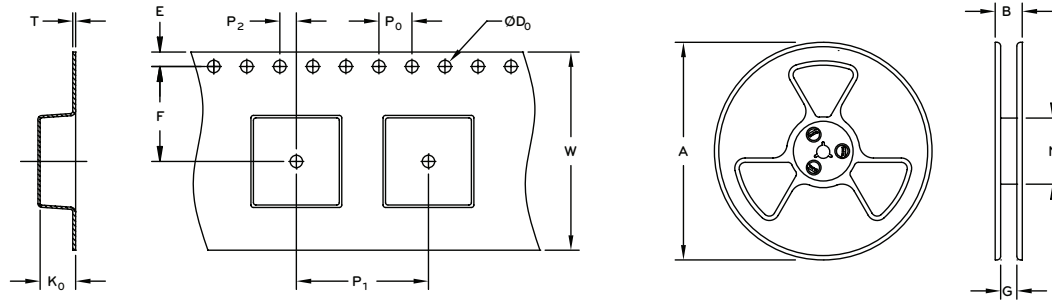

## SURFACE MOUNTING TYPE, REEL/TAPE LIST

	REEL SIZE (mm)				TAPE SIZE (mm)									QTY
	A	B	G	N	E	F	D <sub>0</sub>	P <sub>1</sub>	P <sub>0</sub>	P <sub>2</sub>	W	T	K <sub>0</sub>	PCS/REEL
PA4334.XXXNLT	Ø178	14.4	8.4	58	1.75	3.5	1.5	4	4	2	8	0.25	1.6	2000

## Typical Performance Curves

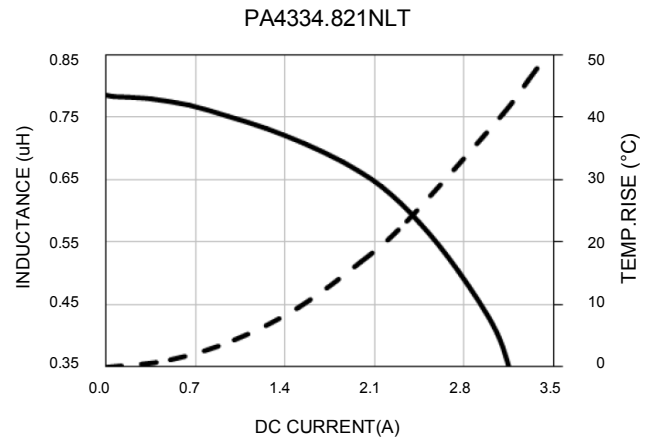
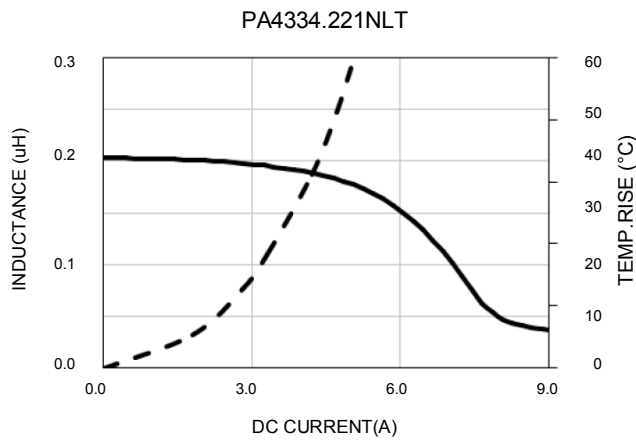

# SMT Power Inductor

Shielded Drum Core - PA4334.XXXNLT Series

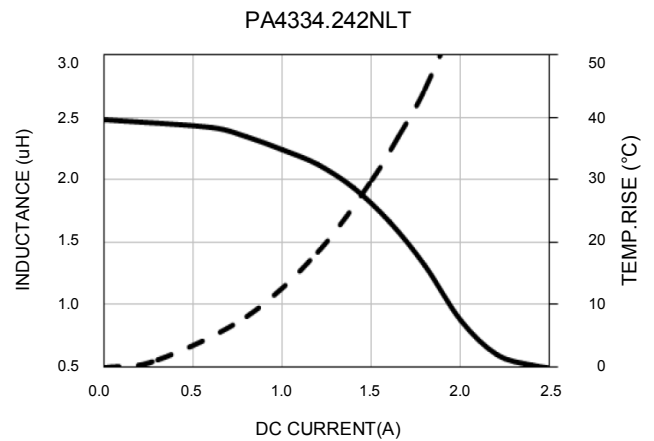
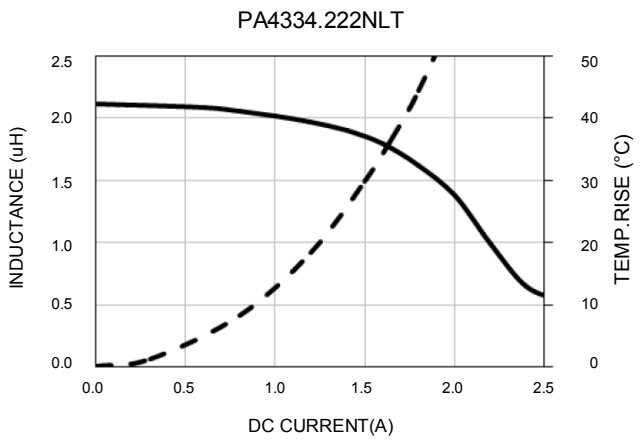
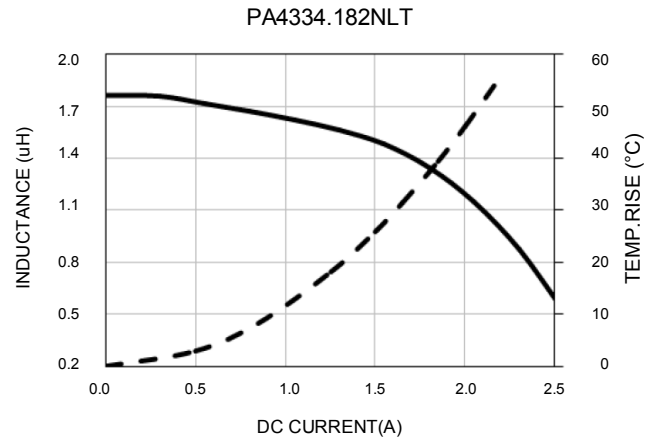
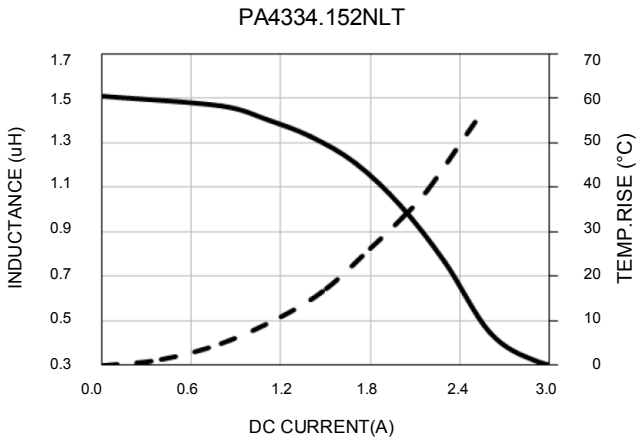
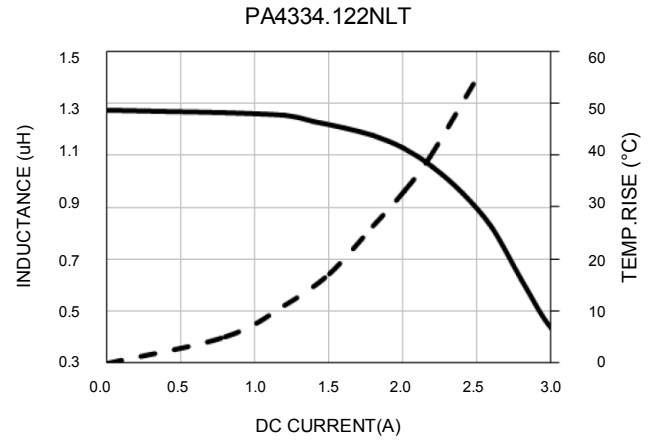
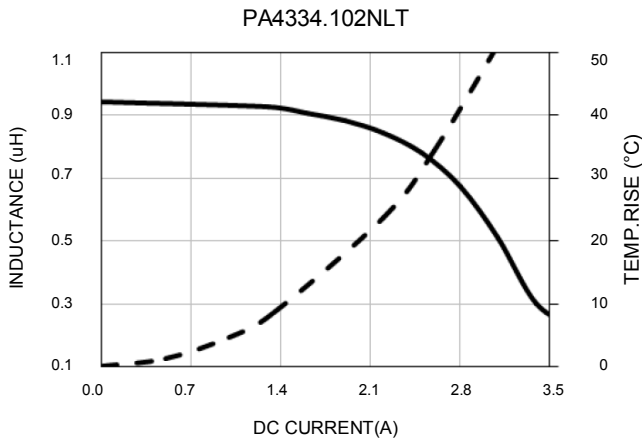

# SMT Power Inductor

Shielded Drum Core - PA4334.XXXNLT Series

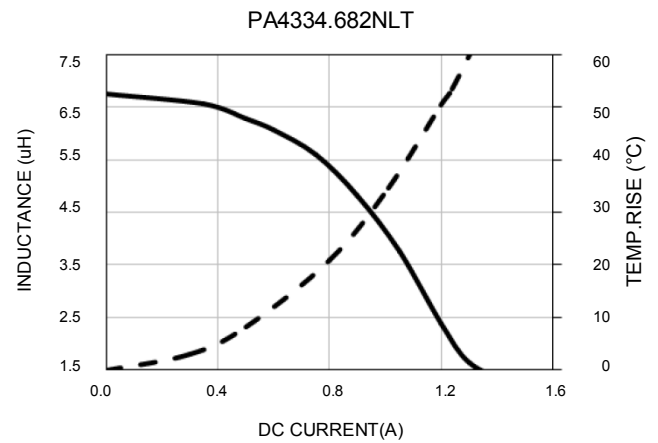
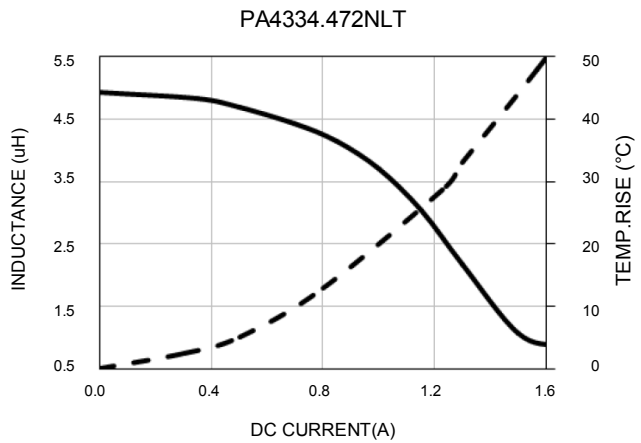
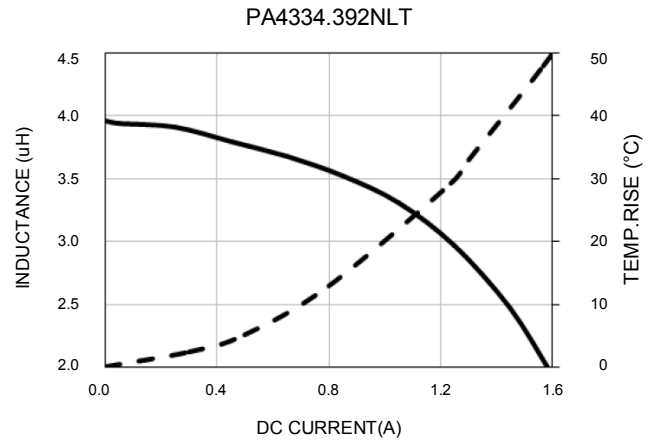
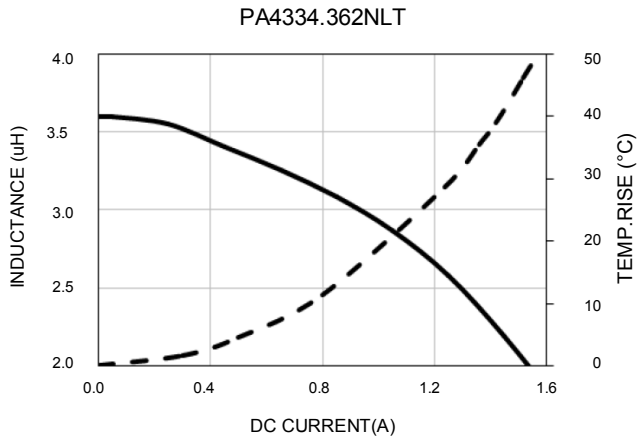
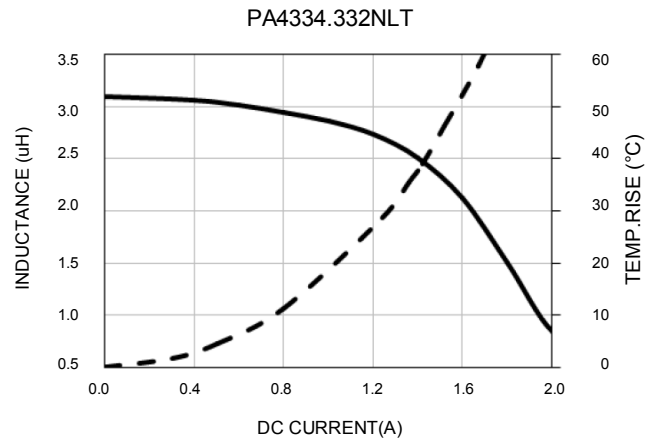
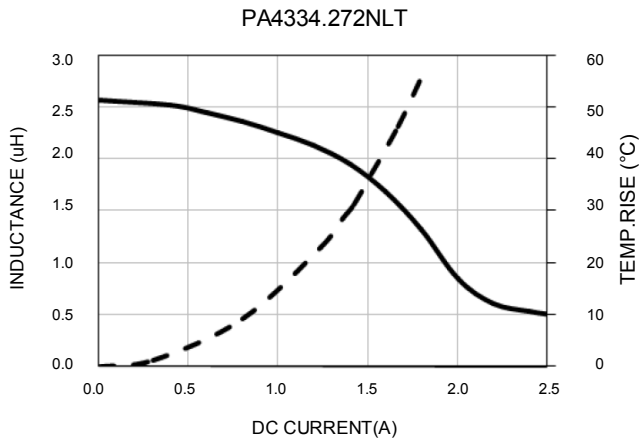

# SMT Power Inductor

Shielded Drum Core - PA4334.XXXNLT Series

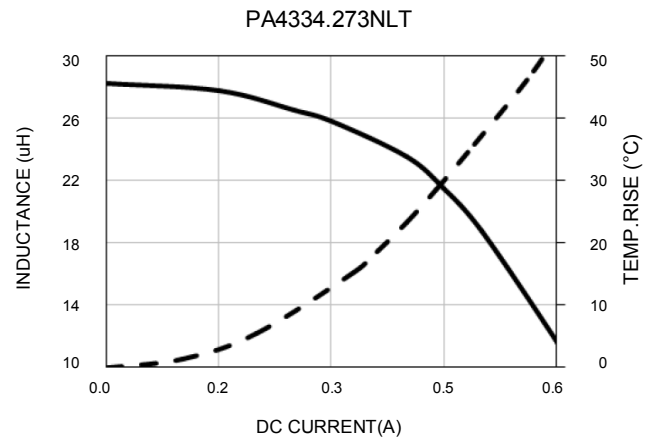
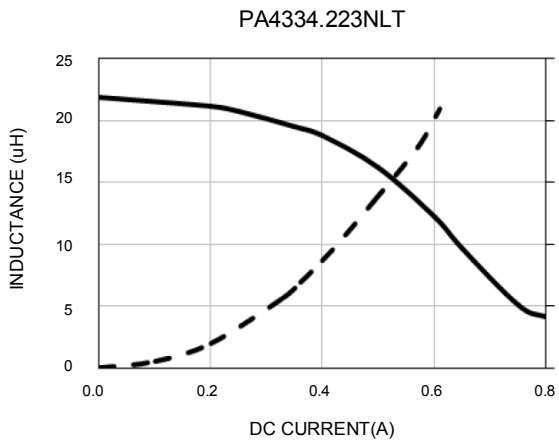
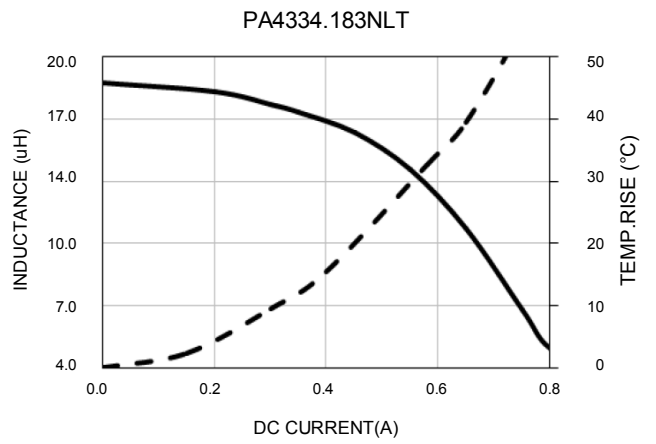
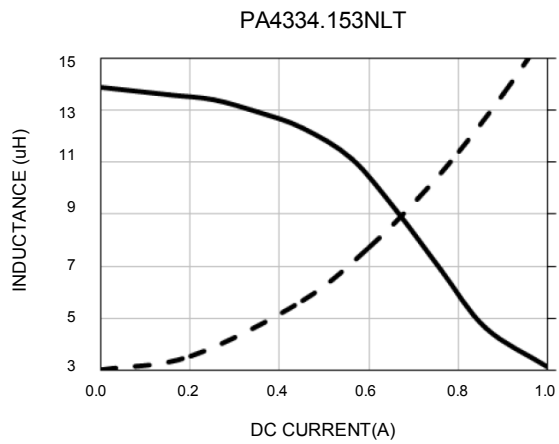
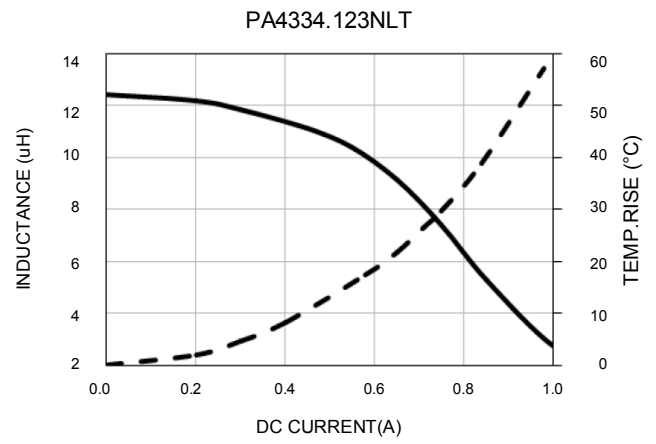
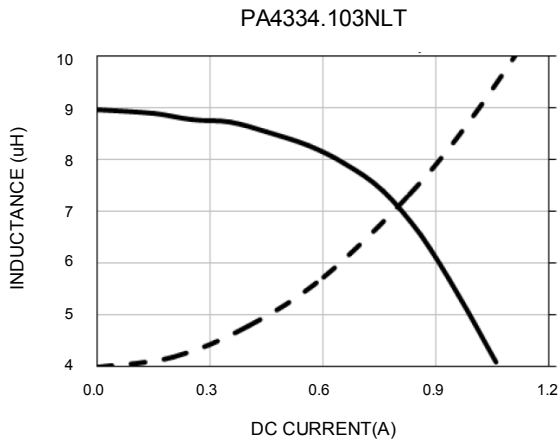

# SMT Power Inductor

Shielded Drum Core - PA4334.XXXNLT Series

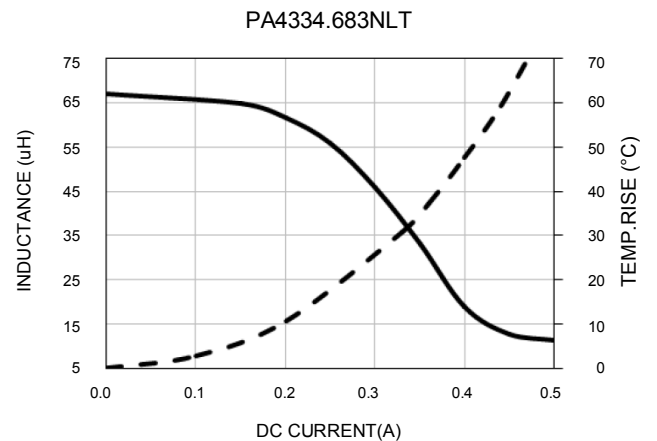
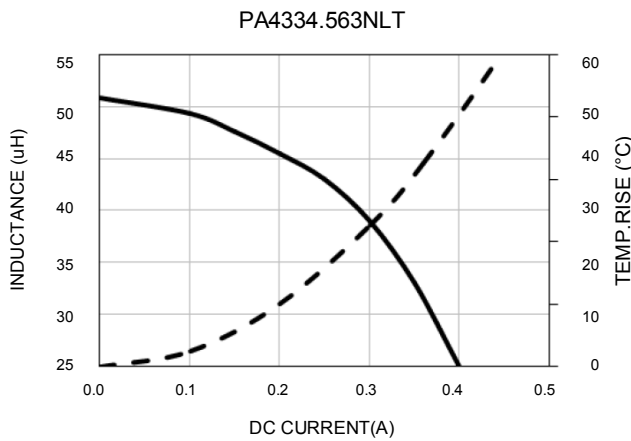
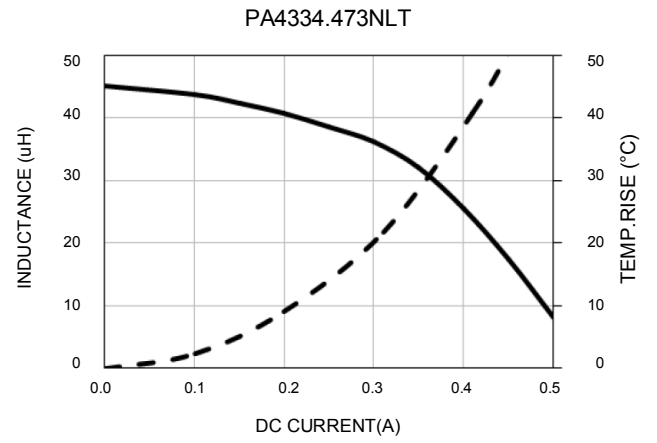
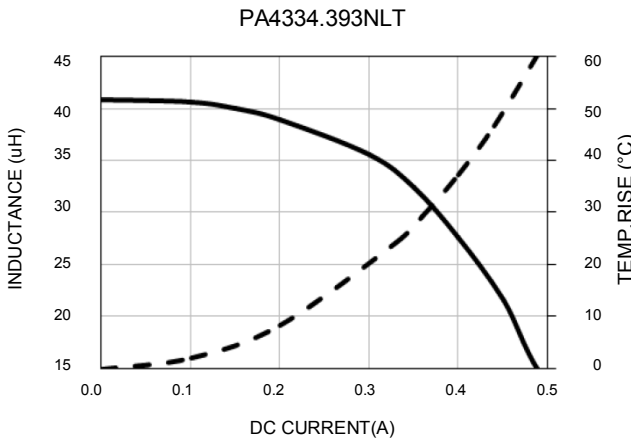
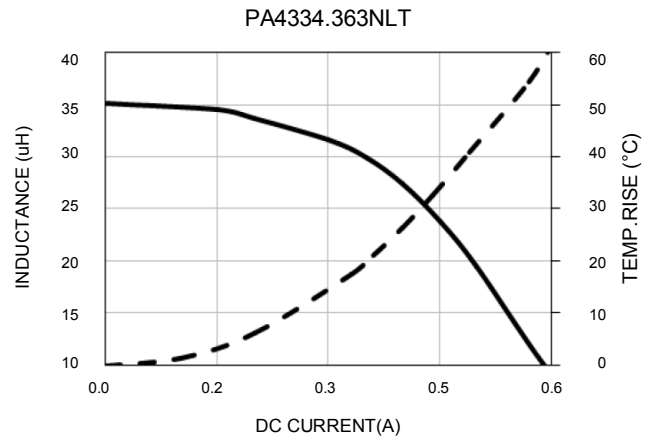
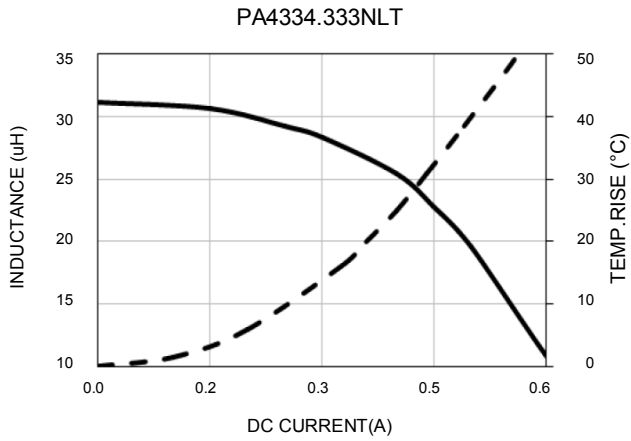

# SMT Power Inductor

Shielded Drum Core - PA4334.XXXNLT Series

PA4334.823NLT

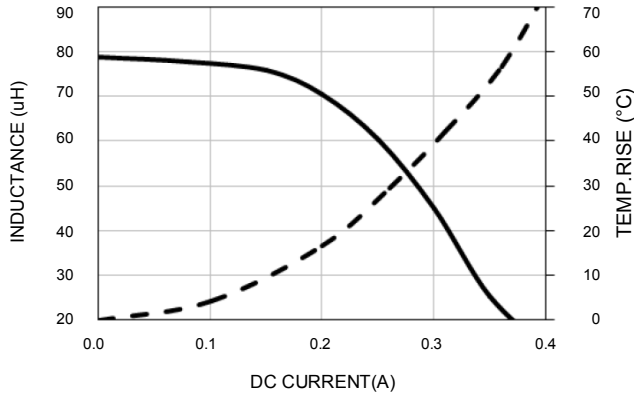

PA4334.104NLT

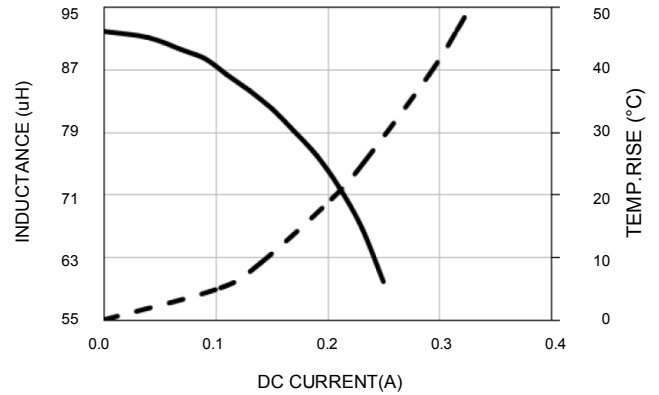

## For More Information

### Pulse Worldwide Headquarters

12220 World Trade Drive  
San Diego, CA 92128  
U.S.A.

Tel: 858 674 8100  
Fax: 858 674 8262

### Pulse Europe

Pulse Electronics GmbH  
Am Rottland 12  
58540 Meinerzhagen  
Germany

Tel: 49 2354 777 100  
Fax: 49 2354 777 168

### Pulse China Headquarters

B402, Shenzhen Academy of  
Aerospace Technology Bldg.  
10th Kejinan Road  
High-Tech Zone  
Nanshan District  
Shenzhen, PR China 518057

Tel: 86 755 33966678  
Fax: 86 755 33966700

### Pulse North China

Room 2704/2705  
Super Ocean Finance Ctr.  
2067 Yan An Road West  
Shanghai 200336  
China

Tel: 86 21 62787060  
Fax: 86 21 62786973

### Pulse South Asia

135 Joo Seng Road  
#03-02  
PM Industrial Bldg.  
Singapore 368363

Tel: 65 6287 8998  
Fax: 65 6287 8998

### Pulse North Asia

3F, No. 198  
Zhongyuan Road  
Zhongli City  
Taoyuan County 320  
Taiwan R. O. C.

Tel: 886 3 4356768  
Fax: 886 3 4356823 (Pulse)  
Fax: 886 3 4356820 (FRE)

Performance warranty of products offered on this data sheet is limited to the parameters specified. Data is subject to change without notice. Other brand and product names mentioned herein may be trademarks or registered trademarks of their respective owners. © Copyright, 2016. Pulse Electronics, Inc. All rights reserved.



## X-ON Electronics

Largest Supplier of Electrical and Electronic Components

*Click to view similar products for [Fixed Inductors](#) category:*

*Click to view products by [Pulse manufacturer](#):*

Other Similar products are found below :

[CR43NP-680KC](#) [CR54NP-820KC](#) [CR54NP-8R5MC](#) [CTX32CT-100](#) [70F224AI](#) [MGDQ4-00004-P](#) [MHL1ECTTP18NJ](#) [MHL1JCTTD12NJ](#)  
[PE-51506NL](#) [PE-53601NL](#) [PE-53602NL](#) [PE-53630NL](#) [PE-53824SNLT](#) [PE-62892NL](#) [PE-92100NL](#) [PG0434.801NLT](#) [PG0936.113NLT](#)  
[9310-16](#) [PM06-2N7](#) [PM06-39NJ](#) [A01TK](#) [1206CS-471XJ](#) [HC2-2R2TR](#) [HC2LP-R47-R](#) [HC3-2R2-R](#) [1206CS-151XG](#) [RCH664NP-140L](#)  
[RCH664NP-4R7M](#) [RCH8011NP-221L](#) [RCP1317NP-332L](#) [RCP1317NP-391L](#) [RCR1010NP-470M](#) [RCR110DNP-331L](#) [DH2280-4R7M](#)  
[DS1608C-106](#) [ASPI-4020HI-R10M-T](#) [B10TJ](#) [B82477P4333M](#) [B82498B3101J000](#) [B82498B3680J000](#) [ELJ-RE27NJF2](#) [1812CS-153XJ](#)  
[1812CS-183XJ](#) [1812CS-223XJ](#) [1812LS-104XJ](#) [1812LS-105XJ](#) [1812LS-124XJ](#) [1812LS-154XJ](#) [1812LS-223XJ](#) [1812LS-224XJ](#)