

## *TABLE of CONTENTS*

### **ISOLATION TRANSFORMERS**

#### **10BASE-T FOR ADAPTER CARDS, MAUs, HUBS AND MOTHERBOARD APPLICATIONS**

Electrical Specifications: Surface Mount and Through Hole . . . . . 2

#### **ETHERNET AUI TRANSFORMERS**

Electrical Specifications: Surface Mount and Through Hole . . . . . 3

#### **APPLICATION CIRCUITS**

10Base-T . . . . . 4

Ethernet . . . . . 5

**SCHEMATICS** . . . . . 6

#### **MECHANICALS**



Surface Mount . . . . . 8

Through Hole . . . . . 10

# ISOLATION TRANSFORMERS FOR 10BASE-T

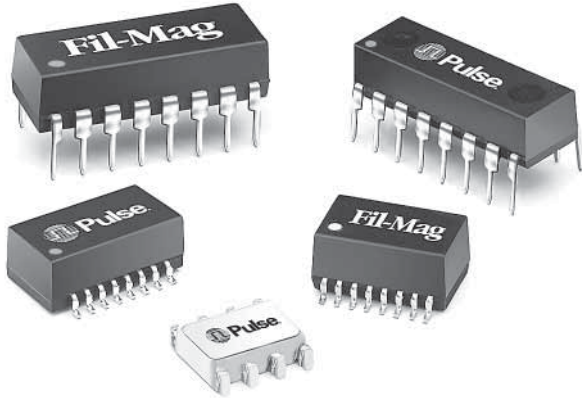
For Adapter Cards, MAUs, Hubs,  
and Motherboard Applications



-  Meets IEEE 802.3 specification
-  Available with common mode chokes for EMI suppression
-  Through hole, auto-insertable, 16-pin DIP package

## Electrical Specifications @ 25°C — Operating Temperature 0°C to 70°C



Part <sup>2</sup> Number	Turns Ratio (±5%)		Primary Pins	Common Mode Choke	Sine Wave Inductance OCL (μH MIN)	Interwinding Capacitance C <sub>ww</sub> <sup>1</sup> (pF MAX)	Leakage Inductance L <sub>l</sub> <sup>1</sup> (μH MAX)	DCR (Ω MAX)	Hipot (Vrms)	Schem.	Mech	
	Transmit	Receive										
<b>SURFACE MOUNT <sup>2</sup></b>											PAGES 6-7	PAGES 8-9
23Z128SM	1CT:1.414CT	1CT:1CT	6-8/1-3	—	200	15	0.5	0.4	2000	T4	SMT5	
23Z356SM	1CT:1.414CT	1CT:1CT	6-8/1-3	✓	200	12	0.5	0.6	2000	T7	SMT5	
23Z467SM	1CT:2CT	1CT:1CT	6-8/1-3	✓	140	12	0.2	0.6	2000	T7	SMT5	
E2023 <sup>4</sup>	1CT: 2.5CT	1CT: 1CT	6-8/1-3	✓	200	15	0.5	0.4	2000	T10	SMT4	
E4001	1CT:2CT	1CT:1CT	6-8/1-3	✓	112	8	0.3	0.8	3000	T5	SMT4	
EX2024 <sup>3</sup>	1CT: 2.5CT	1CT:1CT	6-8/1-3	✓	350	30	0.8	0.6	2000	T10	SMT4	
PE-65454	1:1.414	1:1	3-4/1-2	—	140	12	0.2	0.4	2000	T1	SMT2	
PE-65745	1CT: 1.414CT	1CT:1CT	6-8/1-3	—	140	12	0.2	0.3	1500	T4	SMT4	
PE-68023	1CT:2CT	1CT:1CT	1-3/6-8	✓	200	12	0.3	1.0	1500	T6	SMT4	
PE-68048	1CT: 1.414CT	1CT:1CT	6-8/1-3	✓	110	15	0.4	1.0	1500	T5	SMT4	
PE-68052	2CT:1CT	1CT:1CT	1-3/6-8	✓	140	12	0.3	1.0	1500	T6	SMT4	
PE-68810	—	1:1 (4X)	1-2/3-4	—	140	12	0.2	0.4	2000	T3	SMT4	
PE-68820	1:1.414 (4X)	—	1-2/3-4 5-6/7-8	—	40	12	0.2	0.4	2000	T3	SMT4	
<b>THROUGH HOLE</b>											PAGE 6	PAGE 10
23Z128	1CT: 2CT	1CT:1CT	6-8/1-3	—	140	15	0.5	0.4	2000	T4	TH3	

1. OCL, C<sub>ww</sub> and L<sub>l</sub> are measured at 20 mVrms, 100 kHz.
2. For Tape & Reel packaging, add the suffix "T" to the end of the part number when ordering. e.g. E2023T.
3. Part numbers denoted "EX" are extended temperature parts -40°C to 85°C, electrical specifications @ 25°C.
4. E2023NL is the RoHS compliant version of E2023.

# ISOLATION TRANSFORMERS FOR ETHERNET

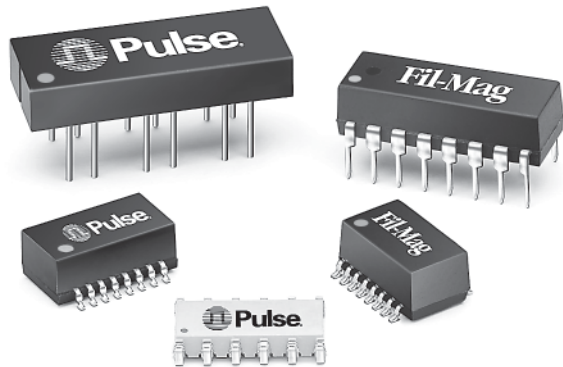
## AUI Transformers



-  Low leakage inductance and coupling capacitance for faster rise times
-  Small form factor, 50 mil lead spacing
-  Through hole, auto-insertable, 16-pin DIP package

### Electrical Specifications @ 25°C — Operating Temperature 0°C to 70°C

Part Number <sup>3</sup>	Turns Ratio (±5%)	Primary Pins	Primary Sine Wave OCL <sup>1</sup> (μH ±20%)	Primary ET-Constant (V-μs MIN)	Rise Time <sup>2</sup> (ns MAX)	Interwinding Capacitance C <sub>ww</sub> <sup>1</sup> (pF MAX)	Leakage Inductance L <sub>L</sub> <sup>1</sup> (μH MAX)	DCR (Ω MAX)	Schem.	Mech.	Hipot (Vrms)
<b>SURFACE MOUNT<sup>3</sup></b>											
									PAGE 6	PAGES 8-9	
23Z90SM	1:1	1-2/4-5/7-8	75	2.4	3.0	10	0.20	0.20	T2	SMT5	2000
23Z91SM	1:1	1-2/4-5/7-8	100	2.4	3.0	10	0.20	0.30	T2	SMT5	2000
23Z108SM <sup>5</sup>	1:1	1-2/4-5/7-8	350	2.5	3.5	16	0.30	0.35	T2	SMT5	2000
PE-65723	1:1	1-2/4-5/7-8	75	1.8	3.0	8	0.20	0.30	T2	SMT4	2000
PE-65727	1:1	1-2/4-5/7-8	150	1.2	3.0	12	0.20	0.30	T2	SMT4	2000
PE-65728	1:1	1-2/4-5/7-8	100	1.8	3.0	9	0.20	0.30	T2	SMT4	2000
<b>THROUGH HOLE</b>											
									PAGES 6	PAGE 9-10	
PE-64108	1:1	1-2/4-5/7-8	100	2.1	3.5	10	0.25	0.40	T2	TH2	2000
PE-64109	1:1	1-2/4-5/7-8	150	3.0	3.0	15	0.20	0.45	T2	TH2	2000

1. OCL, C<sub>ww</sub> and L<sub>L</sub> are measured at 20 mVrms, 100 kHz.
2. Rise time is measured in 75 Ω systems.
3. For Tape & Reel packaging, add a suffix "T" to the end of the part number when ordering. e.g. PE-65723T.

## Typical Application Circuit

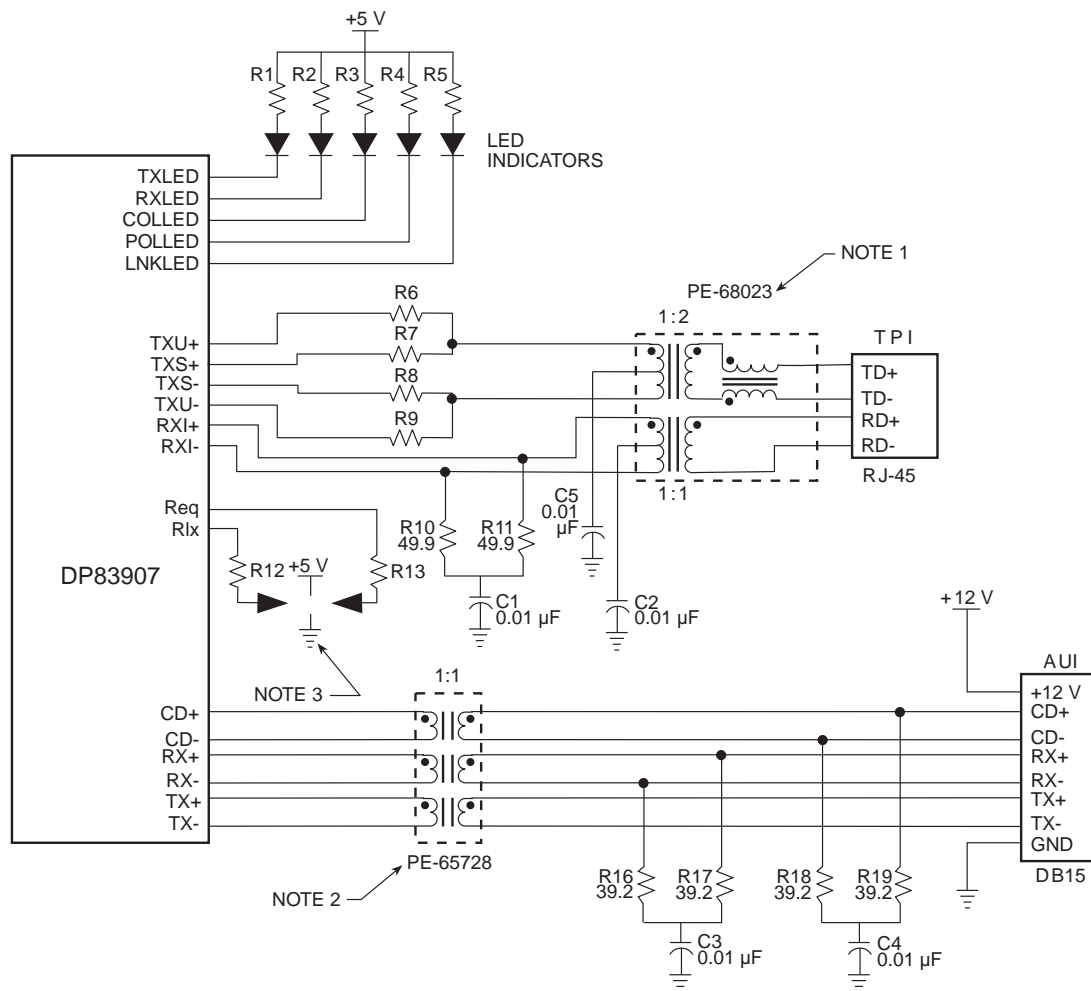

**NOTES:**

1. Connections at pins 12 and 13 apply to PE-68023 only. These are test points. Do not ground.
2. For specific information, see pages 2 and 3 in this catalog.
3. For specific connection, refer to National's Application Notes.

## Typical 10Base-T Application Circuit

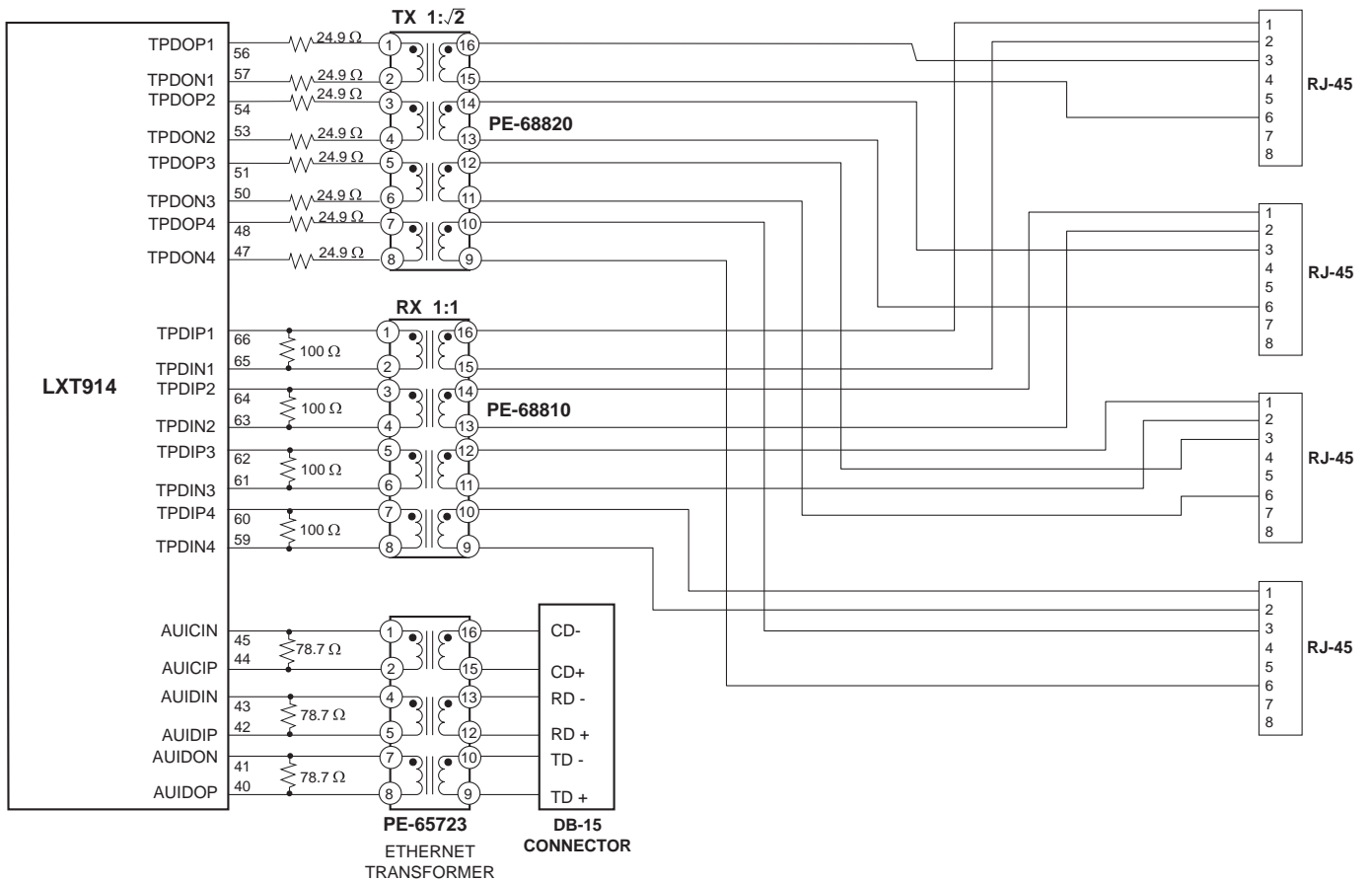

## Schematics

---

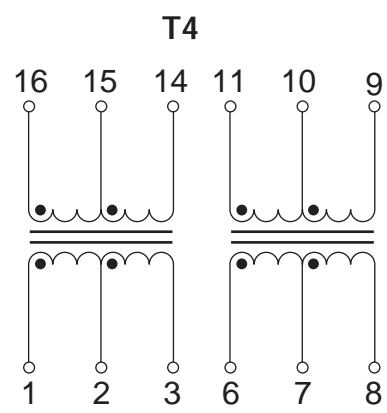
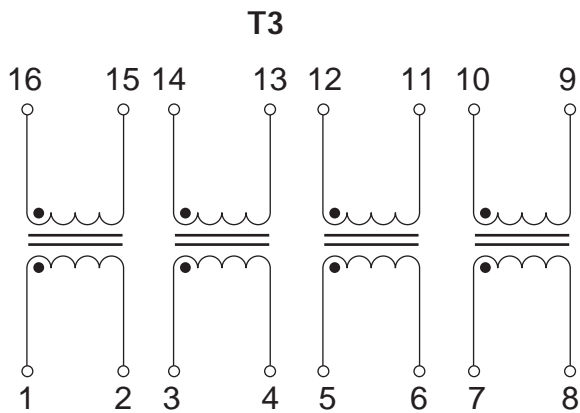
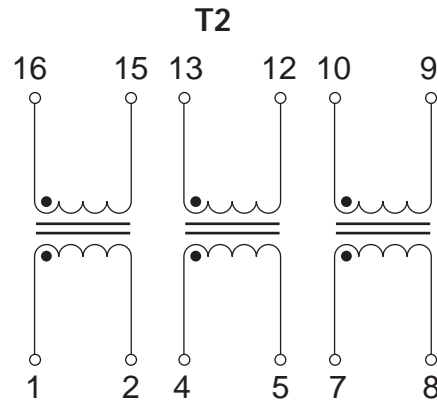
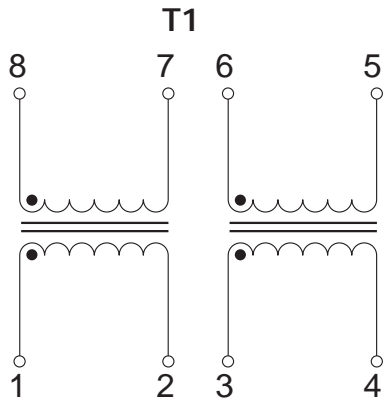

## Schematics (continued)

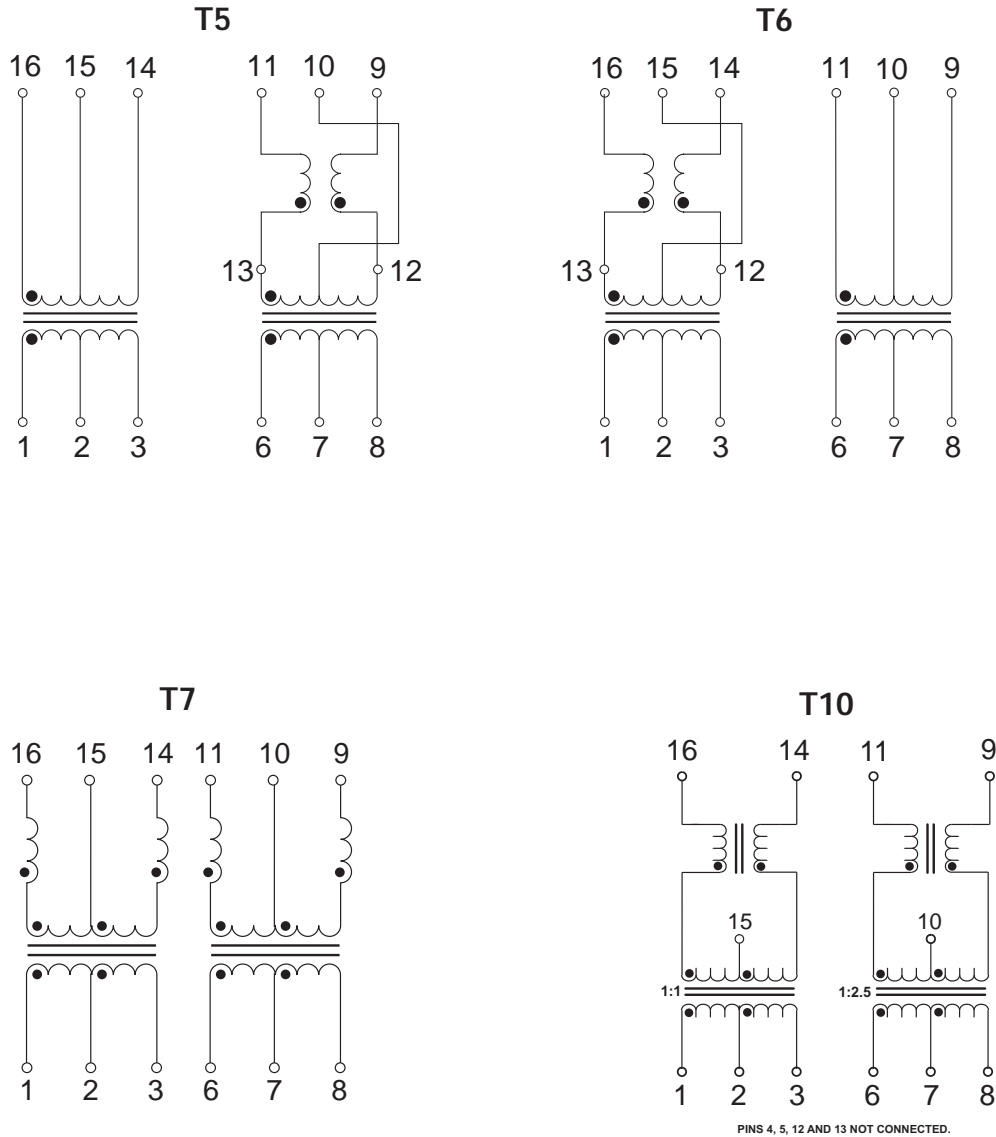

## Surface Mount Mechanicals

### SMT2

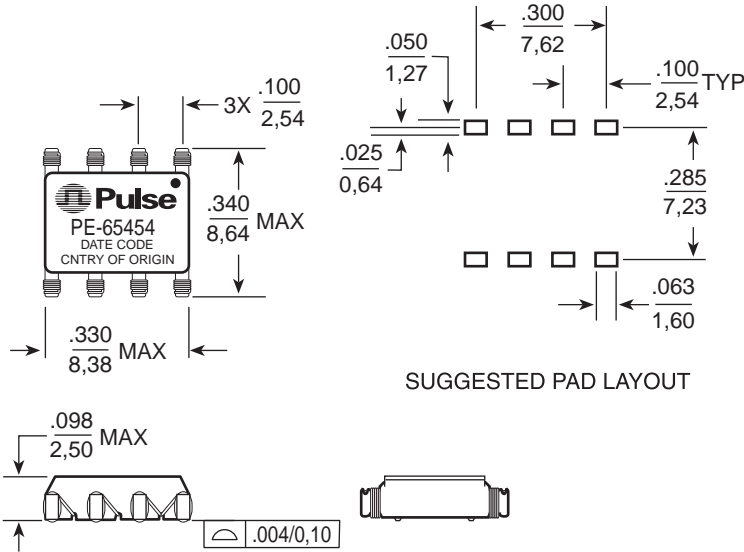

Dimensions:  $\frac{\text{Inches}}{\text{mm}}$

Unless otherwise specified, all tolerances are  $\pm \frac{.010}{0,25}$

Weight ..... 0.22 grams  
 Tube ..... .60/tube  
 Tape & Reel ..... 1500/reel

### SMT4

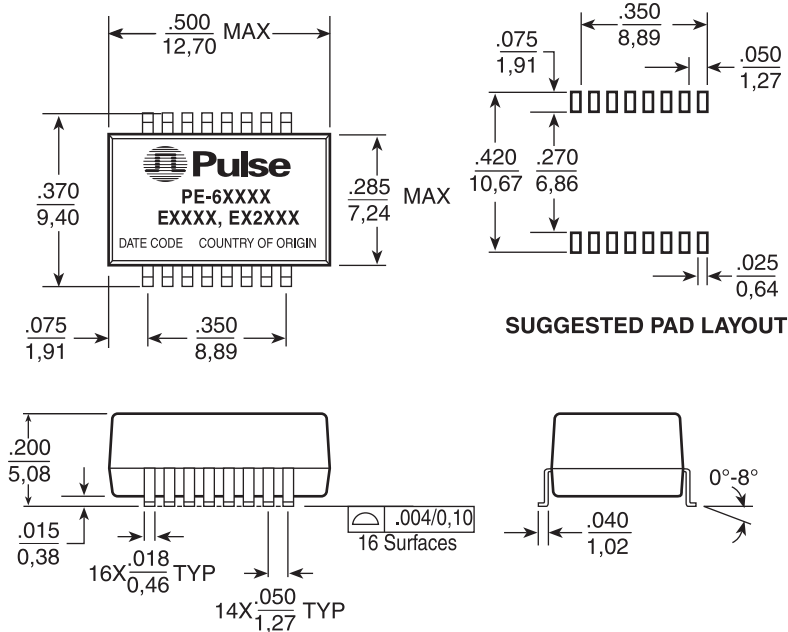

Dimensions:  $\frac{\text{Inches}}{\text{mm}}$

Unless otherwise specified, all tolerances are  $\pm \frac{.010}{0,25}$

Weight ..... 0.82 grams  
 Tube ..... .40/tube  
 Tape & Reel ..... 900/reel



## Through Hole Mechanicals - (continued)

### SMT5

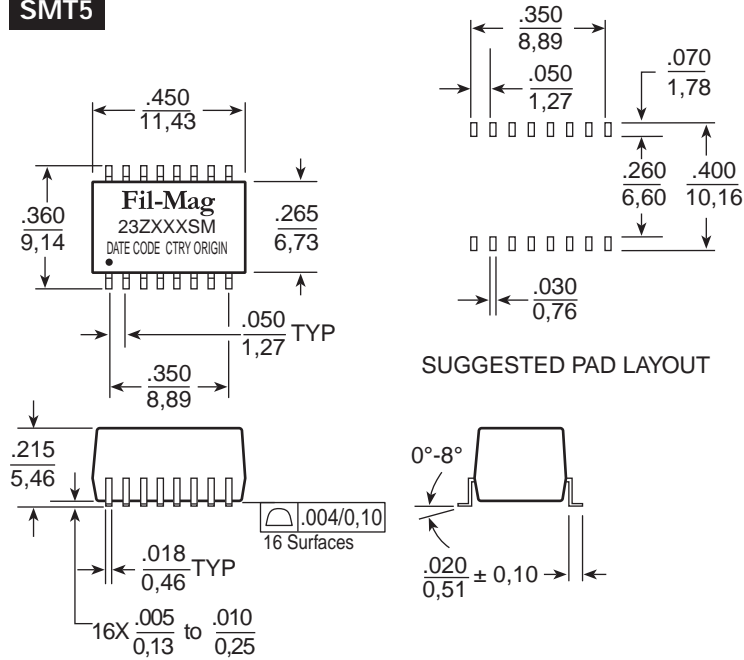

Dimensions:  $\frac{\text{Inches}}{\text{mm}}$

Unless otherwise specified, all tolerances are  $\pm \frac{.005}{0,13}$

Weight ..... 0.85 grams  
 Tube ..... .50/tube  
 Tape & Reel ..... 750/reel

## Through Hole Mechanicals

### TH1

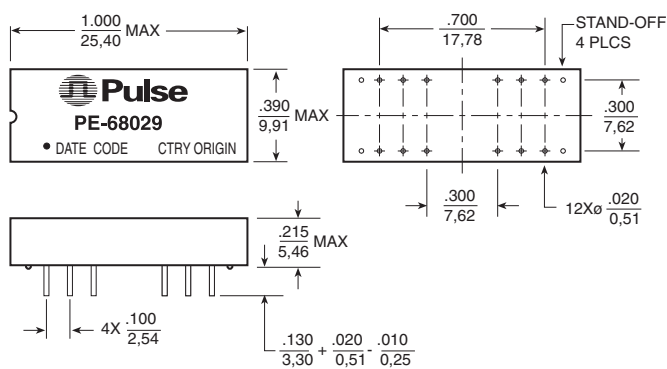

Weight ..... 2.17 grams  
 Tube ..... 20/tube

### TH2

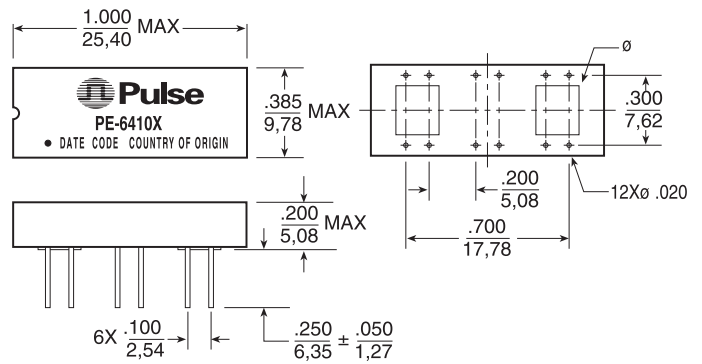

Weight ..... 2.18 grams  
 Tube ..... 20/tube

Dimensions:  $\frac{\text{Inches}}{\text{mm}}$  Unless otherwise specified, all tolerances are  $\pm \frac{.010}{0,25}$

## Through Hole Mechanicals - *continued*

**TH3**

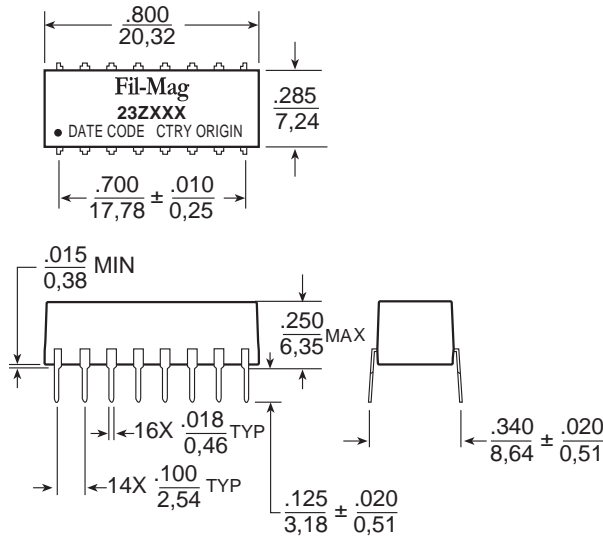

**TH4**

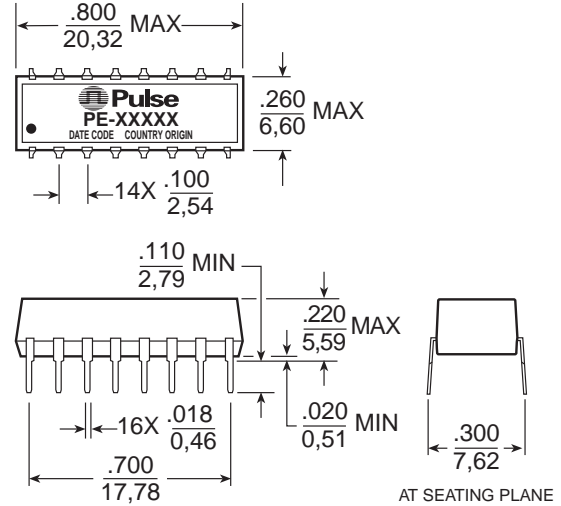

Weight . . . . . 1.7 grams  
 Tube . . . . . 28/tube

Dimensions:  $\frac{\text{Inches}}{\text{mm}}$

Unless otherwise specified, all tolerances are  $\pm \frac{.005}{0,13}$

Dimensions:  $\frac{\text{Inches}}{\text{mm}}$

Unless otherwise specified, all tolerances are  $\pm \frac{.010}{0,25}$

### For More Information:

**Pulse Worldwide Headquarters**  
 12220 World Trade Dr.  
 San Diego, CA 92128  
 U.S.A.

**Pulse Europe**  
 Einsteinstrasse 1  
 D-71083 Herrenberg  
 Germany

**Pulse China Headquarters**  
 B402, Shenzhen Academy of  
 Aerospace Technology Bldg.  
 10th Kejinan Rd.  
 High-Tech Zone  
 Nanshan District  
 Shenzhen, PR China 518057

**Pulse North China**  
 Room 1503  
 XinYin Building  
 No. 888 YiShan Rd.  
 Shanghai 200233  
 China

**Pulse South Asia**  
 135 Joo Seng Rd.  
 #03-02  
 PM Industrial Bldg.  
 Singapore 368363

**Pulse North Asia**  
 No. 26, Kao Ching Rd.  
 Yang Mei Chen  
 Taoyuan Hsien  
 Taiwan  
 R. O. C.

[www.pulseeng.com](http://www.pulseeng.com)

Tel: 858 674 8100  
 Fax: 858 674 8262

Tel: 49 7032 7806 0  
 Fax: 49 7032 7806 135

TEL: 86 755 33966678  
 FAX: 86 755 33966700

Tel: 86 21 54643211/2  
 Fax: 86 21 54643210

TEL: 65 6287 8998  
 FAX: 65 6280 0080

Tel: 886 3 4643715  
 Fax: 886 3 4641911

Performance warranty of products offered on this data sheet is limited to the parameters specified. Data is subject to change without notice. Other brand and product names mentioned herein may be trademarks or registered trademarks of their respective owners.

© Copyright, 2009. Pulse Engineering, Inc. All rights reserved.

## X-ON Electronics

Largest Supplier of Electrical and Electronic Components

*Click to view similar products for [Audio Transformers](#) / [Signal Transformers](#) category:*

*Click to view products by [Pulse manufacturer](#):*

Other Similar products are found below :

[CU4S0506AT-2655-H1](#) [MGPWT-00449-P](#) [PE-64961](#) [1812WBT2-4](#) [BX1194WNL](#) [1879479-1](#) [PA1528ANL](#) [T1137NLT](#) [T3012NL](#) [PE-65848FNLT](#) [H5019EFNL](#) [CX2045ALNLT](#) [MET-14](#) [MGPWT-00059-P](#) [MGPWT-00266-P](#) [MGPWT-00278-P](#) [MGPWT-00431-P](#) [TTC-100](#) [TTC-143-H](#) [TTC-5032-1](#) [4-1879391-0](#) [100213](#) [T1142NL](#) [T1124NL](#) [1879732-1](#) [2-1879391-5](#) [B8846NL](#) [MABA-010321-CT1A42](#) [TX1341NL](#) [H0013FNL](#) [H5020FNL](#) [H2009FNLT](#) [H5004NLT](#) [S553-5999-52-F](#) [T5008NLT](#) [PE-68517T](#) [TG111-E212NWLFR](#) [MGPWT-00339-P](#) [H5014FNLT](#) [TX1473NLT](#) [PE-69011NLT](#) [CX2043LNLT](#) [H7137FNLT](#) [H1259NLT](#) [TX1344NLT](#) [LM-LP-1005L](#) [H0013NLT](#) [S558-5500-JV](#) [TX1193NLT](#) [T7015NL](#)