

High Isolation Power Transformer

Shaped Core Platform SMD

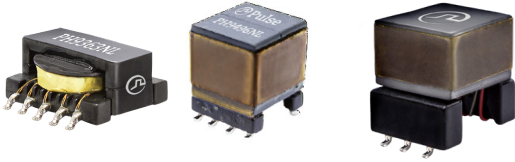

- Ⓢ Flyback Converter Transformer
- Ⓢ Designed for Broadcom ACPL-32JT and ACPL-302J IGBT Gate Driver
- Ⓢ Compact and cost effective industrial design
- Ⓢ PH9363NL: Basic insulation, 2.8mm creepage
- Ⓢ PH9496NL: Basic insulation, 6.2mm creepage
- Ⓢ PH0416NL: Reinforced insulation, 8.3mm creepage
PM2277NLT: Basic Insulation, 6.2mm creepage; 10G vibration

Electrical Specifications @ 25°C - Operating Temperature -40°C to +125°C

Commercial	Automotive	Inductance (Pri) ($\mu\text{H} \pm 10\%$)	Primary Current (A MAX)	Inductance (Sec) ($\mu\text{H} \pm 10\%$)	DCR (Sec) (Ω MAX)	Leakage Inductance (Pri) (μH Max)	Turns Ratio	Isolated Voltage (Vrms)
PH9363NL	n/a	60	1.0	240	0.60	3.0	1:2	2500 / 1 minute
PH9496NL	PM2277NLT	52	1.7	332	0.22	1.2	1:2.53	2500 / 1 minute
PH0416NL	n/a	43	1.0	172	1.2	2	1:2	5000 / 1 minute

Notes:

1. These transformers are approved by Broadcom to deliver a isolated 18V IGBT drive voltage from a 8V-18V source.
2. Optional Tape & Reel packing can be ordered by adding a "T" suffix to the part number.
3. Other turns ratios and isolation levels available on request.
4. The rated primary current is based on a peak flux density of 220mT.
5. PM2277 is automotive grade

Mechanical

Schematic

PH9363NL

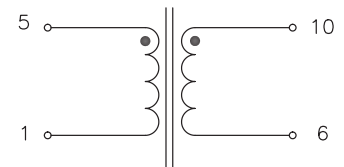
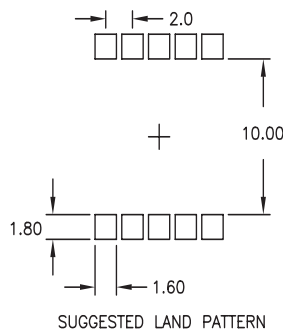
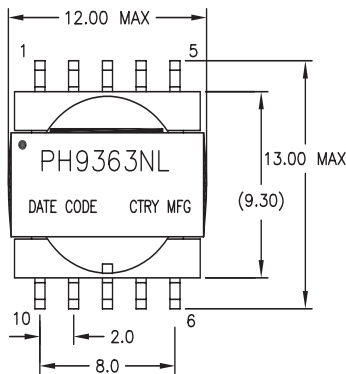

Weight1.4grams
Tape & Reel500/reel
Tray100/tray

Dimensions: mm

Unless otherwise specified,
all tolerances are ± 0.25

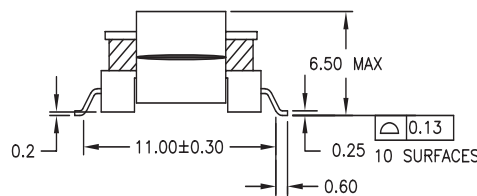
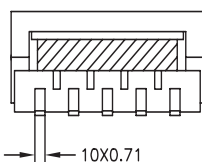

FINAL OUTLINE

High Isolation Power Transformer

Shaped Core Platform SMD

PH9496NL

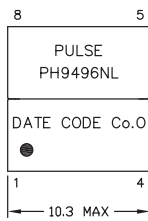

Mechanical

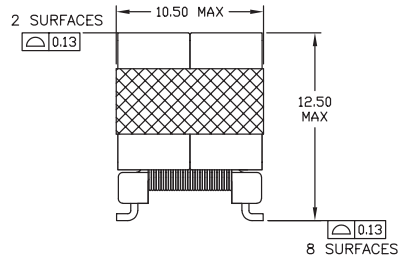
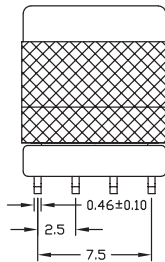
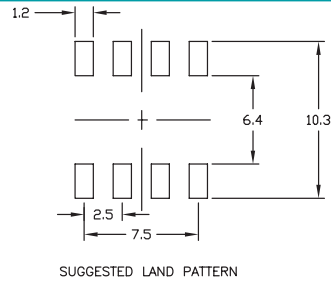

Schematic

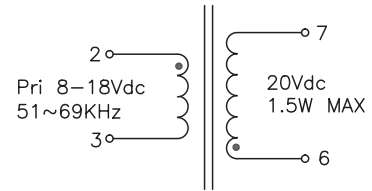

Weight2.6grams
Tape & Reel175/reel
Tray90/tray
Dimensions: mm

Unless otherwise specified,
all tolerances are±0.25

PH0416NL

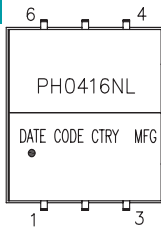

Mechanical

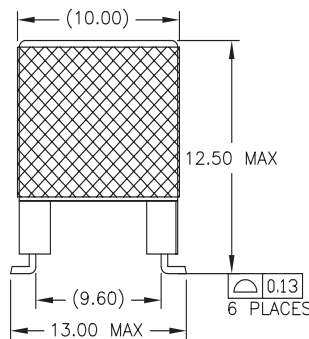
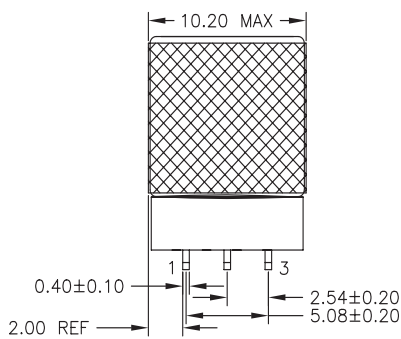
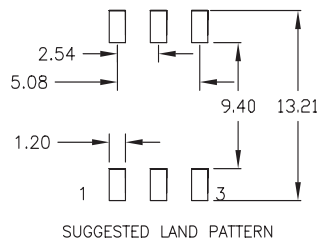

Schematic

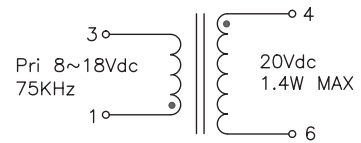

Weight2.6grams
Tape & Reel150/reel
Tray80/tray
Dimensions: mm

Unless otherwise specified,
all tolerances are±0.25

High Isolation Power Transformer

Shaped Core Platform SMD

Mechanical

Schematic

PM2277NL

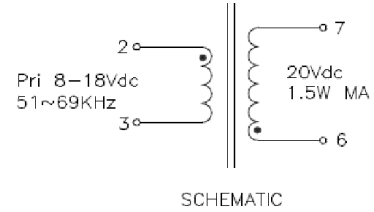
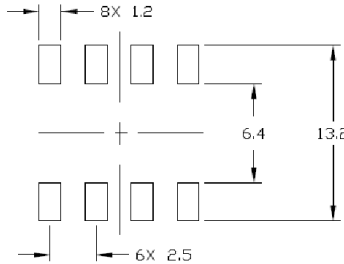
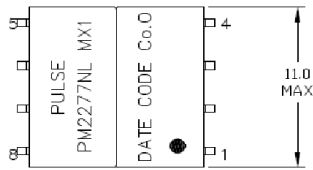

Weight3.4grams
Tape & Reel175/reel

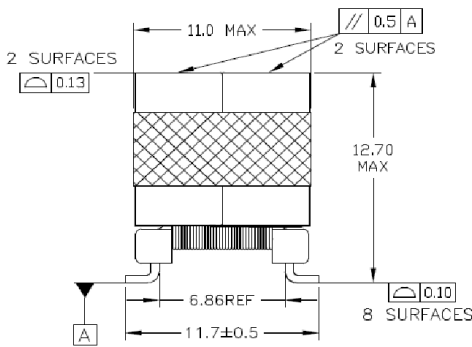

SUGGESTED LAND PATTERN

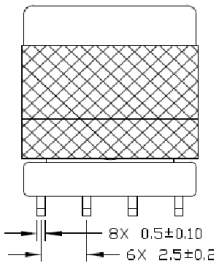

For More Information

Americas - proinfo_power_americas@yageo.com | Europe - proinfo_power_emea@yageo.com | Asia - proinfo_power_asia@yageo.com

Performance warranty of products offered on this data sheet is limited to the parameters specified. Data is subject to change without notice. Other brand and product names mentioned herein may be trademarks or registered trademarks of their respective owners. © Copyright, 2023. Pulse Electronics, Inc. All rights reserved.

YAGEO Corporation and its affiliates do not recommend the use of commercial or automotive grade products for high reliability applications or manned space flight.

X-ON Electronics

Largest Supplier of Electrical and Electronic Components

Click to view similar products for [Power Transformers](#) category:

Click to view products by [Pulse manufacturer](#):

Other Similar products are found below :

[F-181U](#) [F-204U](#) [F-206U](#) [F-227X](#) [F-23U](#) [F-264U](#) [F-267U](#) [F-35U](#) [F-412X](#) [F-55X-1](#) [F-68U](#) [F-71U](#) [F-72Z](#) [F-74U](#) [F-83A](#) [F-84AC](#) [F-85U](#) [F-86U](#) [F-9U](#) [PCT-02](#) [PCT-03](#) [PCT6630](#) [PF2.5-20](#) [PPC-14](#) [PPC-46](#) [PPC-58](#) [PSD4-36](#) [GSD-150](#) [11E009H](#) [11E012H](#) [DSW-2120](#) [DSW-224](#) [DSW-228](#) [DSW-310](#) [DSW-3120](#) [DSW-356](#) [DSW-412](#) [DSW-4120](#) [DSW-424](#) [DSW-448](#) [DSW-456](#) [DSW-556](#) [DSW-610](#) [DSW-6120](#) [DSW-624](#) [DSWC-712](#) [EN216B](#) [N-39X](#) [N-49X](#) [N-4MG-1](#)