

A	B	C	D	E	F	G
MD D	Description		Please follow Pulse Limits for the hazardous substances (RoHS, halogens) in the document "Pulse Hazardous Substances (HS) Limits (RPG002-03)" and "Vendor Survey Questionnaire, Material Composition (LDM-SAF-L0040)".	Reliability Test Spec according to WIHS7.5.33 (Reliability Test Working Instruction) Default test standard is Test Standard A if no definition		
P3	Change the Logo					

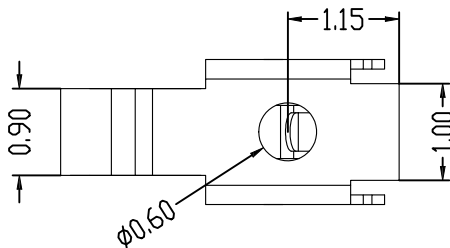

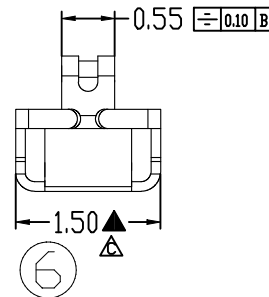
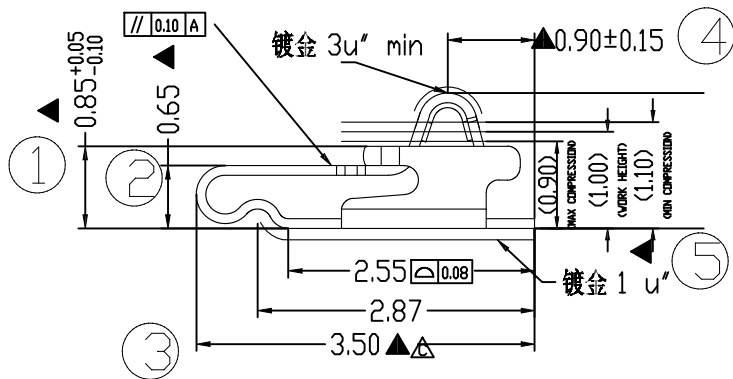
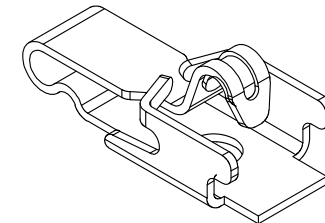
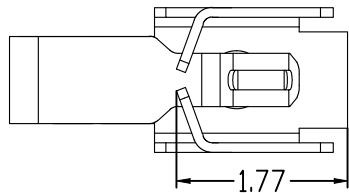

NOTES:UNLESS OTHERWISE SPECIFIED

1. MATERIAL: SUS304-H
2. NO CRACK APPEARS ON CONTACT BALL SHAPE.
3. NO LINES APPEARS ON BENDING AREA.
4. ALL UNSPECIFIED RADII TO BE 0.05 MAXIMUM .
5. BURR:0.03MAX;CUMBER:1.5MM MAX/500MM; TWIST:20°/500MM.
6. PRE-LOAD FORCE:0.40N ON CONTACT POINT
7. PLATING: 3u"MIN GOLD PLATING ON CONTACT AREA, GOLD FLASH PLATING ON SOLDER AREA, 50u" MIN NICKEL PLATING OVER ALL

Confidential
This is a proprietary information of Pulse Suzhou.
No reproduction/copying is allowed without permission.

Functional Characteristics Key (Cpk requirement : Cpk) >
 ◆ Process Capability Studies required(total pcs)
 ◆ Ongoing Statistical Process Control Required (total pcs)
 ◆ Critical dimension need to be measured, no CPK requirement (total pcs)

.X± 0.15
.XX± 0.10
.XXX± 0.05
X:± 5°

PULSE (SUZHOU) WIRELESS PRODUCTS CO.LTD.		THIRD ANGLE PROJECTION		SHEET NUMBER		1 / 1	
 99 HUOJU RD. SUZHOU NEW DISTRICT 215009 P.R.CHINA				GENERAL TOLERANCE			
PRODUCT(S) SW0180N		SCALE 4.000		DESIGN JACKIE JUN-28-18		CUSTOMER NUMBER	
ITEM TX80101-001 (CLIP)		DOCUMENT NUMBER SW0180N		CHECKED MARK Nov-22-17		APPROVED JAMES Nov-22-17	
		PART VERSION P01		DOCUMENT VERSION P3		P2 Oct-26-18 Chris P1 JUN-28-18 JACKIE MOD DATE NAME	

X-ON Electronics

Largest Supplier of Electrical and Electronic Components

Click to view similar products for [Circuit Board Hardware - PCB category](#):

Click to view products by [Pulse manufacturer](#):

Other Similar products are found below :

[8919-0-00-15-00-00-03-0](#) [0135-0-15-01-30-27-04-0](#) [5970-1-15-01-32-14-04-0](#) [0149-0-15-15-30-27-04-0](#) [MBI 1 BLUE](#) [7305-0-15-15-47-14-10-0](#) [8579-0-15-80-11-27-10-0](#) [8579-1-15-15-11-27-10-0](#) [8830-0-15-01-22-14-10-0](#) [8836-0-00-21-00-00-03-0](#) [PRUEF 1 RED](#) [PRUEF 2 RED](#) [9976-0-00-00-00-00-03-0](#) [PW1616](#) [1215-3-05-00-00-00-01-0](#) [1231](#) [1303-0-15-15-47-14-04-0](#) [1404-3](#) [1404-4](#) [1406-4](#) [1407-3](#) [1406-3](#) [1407-4](#) [1408-3](#) [1424-4](#) [1427-3](#) [1419-4](#) [1426-4](#) [MPS 1 BLACK](#) [1548-103](#) [1938-0-00-00-00-00-03-0](#) [1942-0-00-00-00-00-03-0](#) [2101-3-00-44-00-00-07-0](#) [2108-2-00-50-00-00-07-0](#) [2109-2-00-44-00-00-07-0](#) [2110-2-00-44-00-00-07-0](#) [2111-2-00-00-00-00-07-0](#) [2113-4-00-44-00-00-07-0](#) [2301-3-00-44-00-00-07-0](#) [2308-1-00-50-00-00-07-0](#) [2313-2-00-00-00-00-07-0](#) [2315-2-01-44-00-00-07-0](#) [2317-2-00-50-00-00-07-0](#) [2333-1-00-50-00-00-07-0](#) [9000-0-00-00-00-00-03-0](#) [2506-2-00-50-00-00-07-0](#) [2507-2-01-44-00-00-07-0](#) [2508-2-00-44-00-00-07-0](#) [2561-2-00-44-00-00-07-0](#) [9220](#)