

# COMMON MODE CHOKE CATALOG

Suited for LAN and Telecom Applications



## *TABLE of CONTENTS*

### **Common Mode Chokes for Datacom Applications**





Surface Mount Common Mode Chokes ..... 2-6

Through Hole Common Mode Chokes ..... 7-12

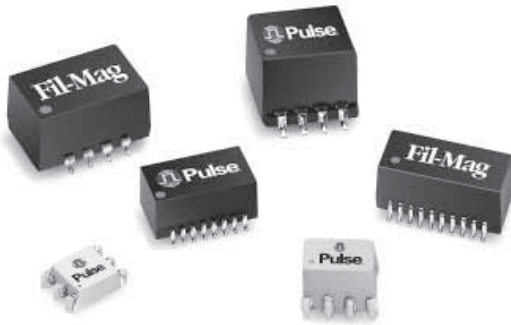
# SURFACE MOUNT COMMON MODE CHOKES

## Suited for LAN and Telecom Applications



-  Reduces radiated EMI emissions
-  Filters common mode noise for EMI reduction
-  Common mode attenuation from 100 kHz to 1 GHz
-  Tape & Reel packaging available for surface mount parts\*

### Electrical Specifications @ 25°C

Part Number	No. of Ports	Primary Inductance OCL (μH MIN)	Common Mode Attenuation (db TYP)									DCR (Ω MAX)	Page Number Mech & Schem
			100 KHz	1 MHz	10 MHz	30 MHz	50 MHz	100 MHz	300 MHz	500 MHz	1 GHz		
PE-68624	2	47	11	27	40	44	42	36	26	17	—	0.40	2
PE-65855	2	4700	41	43	49	39	34	26	20	20	12	1.0	4
B2013	2	6300	46	47	43	32	25	29	21	14	16	1.0	3
B4003	2	4700	42	41	48	38	33	21	22	23	17	1.0	6
23Z87SM	3	69	9	24	31	30	29	27	21	16	—	0.20	4
PE-65857	4	22.5	7	20	30	37	38	34	24	13	—	0.22	4
PE-68627	4	24	8	21	32	36	37	36	30	20	—	0.25	4
T8003	4	33	9	13	32	32	30	27	16	17	13	0.20	6
23Z4000SMD	4	36	7	23	35	38	38	36	29	24	—	0.50	5
PE-65854	4	47	3	19	32	36	35	29	12	6	—	0.40	3
23Z104SM	4	68	8	22	28	28	27	25	20	15	—	0.20	5
PE-67540	4	100	14	33	44	48	49	44	34	29	20	0.60	4
PE-65853	4	4700	40	51	38	30	25	20	14	13	—	1.20	3
23Z106SM	6	68	8	22	29	30	30	29	24	19	—	0.20	5
PE-69011	8	36	8	24	36	39	35	29	18	11	—	0.35	3
23Z105SM	8	68	8	24	30	29	27	24	16	11	—	0.20	5
23Z109SM	10	7.5	4	9	20	25	26	24	16	11	—	0.20	5
T8008	16	47	7	27	40	44	42	36	26	—	—	0.40	6

\* When ordering Tape & Reel packaging, add a "T" at the end of the part number (i.e. PE-65738T or 23Z106SMT).

**NOTE:** Additional common mode chokes are available. Please contact Applications Engineering.

### Mechanical

### Schematic

#### PE-68624

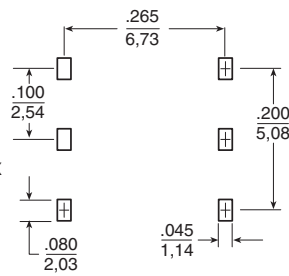
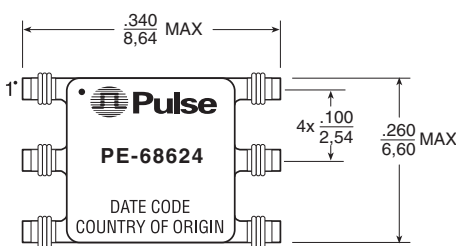

SUGGESTED PAD LAYOUT

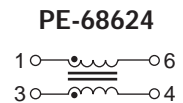
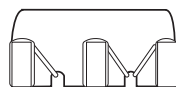
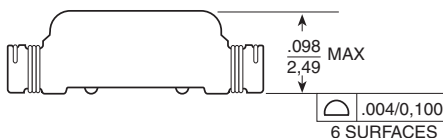

Weight . . . . . 0.17 grams  
Tape & Reel . . . . . 1500/reel  
Tube . . . . . 85/tube

# SURFACE MOUNT COMMON MODE CHOKES

Suited for LAN and Telecom Applications



## Mechanical

## Schematic

### PE-69011

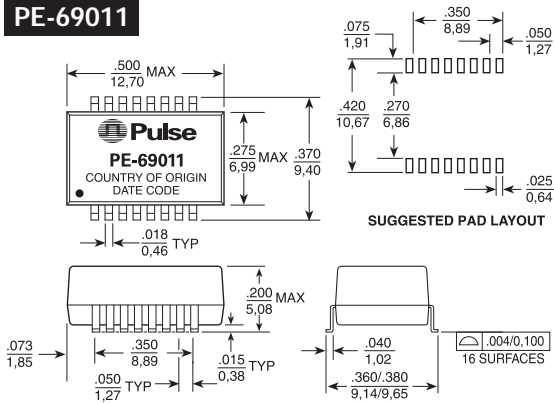

Dimensions:  $\frac{\text{Inches}}{\text{mm}}$

Unless otherwise specified,  
all tolerances are  $\pm .010$   
0,25

Weight . . . . . 0.83 grams  
Tape & Reel . . . . . 900/reel  
Tube . . . . . 40/tube

### PE-69011

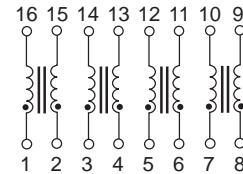

### PE-65853

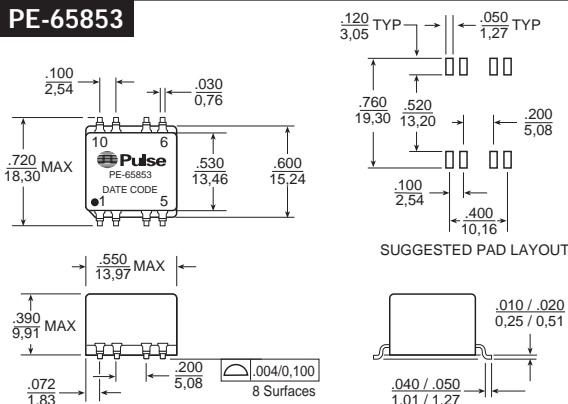

Dimensions:  $\frac{\text{Inches}}{\text{mm}}$

Unless otherwise specified,  
all tolerances are  $\pm .010$   
0,25

Weight . . . . . 4.0 grams  
Tape & Reel . . . . . 150/reel  
Tube . . . . . 35/tube

### PE-65853

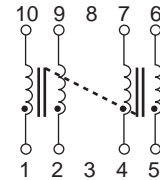

### B2013

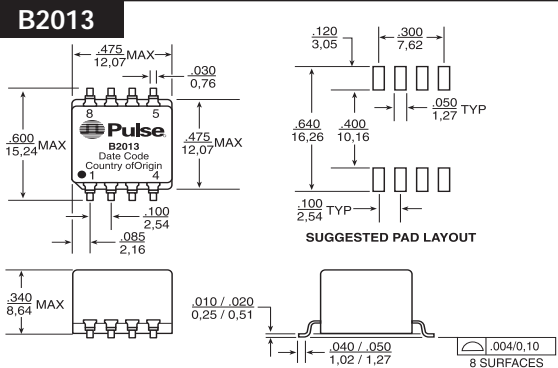

Dimensions:  $\frac{\text{Inches}}{\text{mm}}$

Unless otherwise specified,  
all tolerances are  $\pm .010$   
0,25

Weight . . . . . 9.5 grams  
Tray . . . . . 30/tray

### B2013



### PE-65854

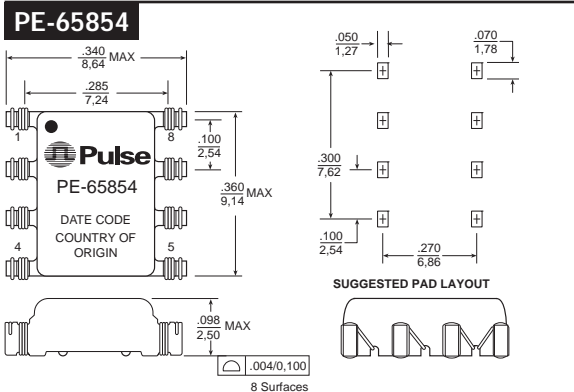

Dimensions:  $\frac{\text{Inches}}{\text{mm}}$

Unless otherwise specified,  
all tolerances are  $\pm .010$   
0,25

Weight . . . . . 0.3 grams  
Tape & Reel . . . . . 1500/reel  
Tube . . . . . 60/tube

### PE-65854

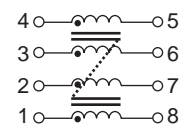

# SURFACE MOUNT COMMON MODE CHOKES

Suited for LAN and Telecom Applications



Mechanical

Schematic

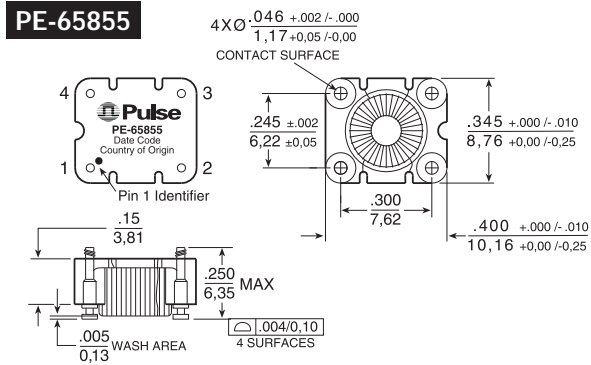

**Dimensions:** Inches  
mm

Unless otherwise specified,  
all tolerances are  $\pm .010$   
0,25

**Weight** . . . . . 0.69 grams  
**Tape & Reel** . . . . . 800/reel  
**Tube** . . . . . 40 /tube

**PE-65855**

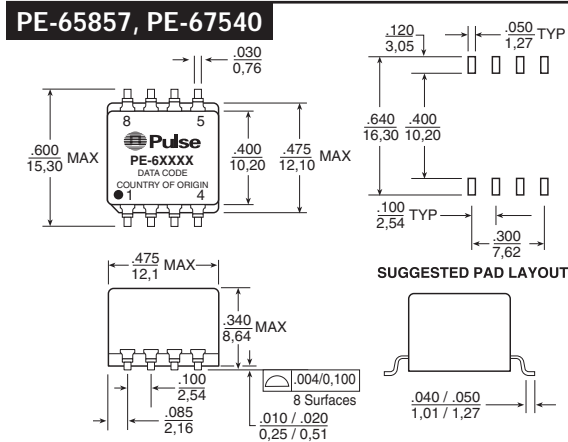

**Dimensions:** Inches  
mm

Unless otherwise specified,  
all tolerances are  $\pm .010$   
0,25

**Weight** . . . . . 2.0 grams  
**Tape & Reel** . . . . . 250/reel  
**Tube** . . . . . 40/tube

**PE-65857**

**PE-67540**

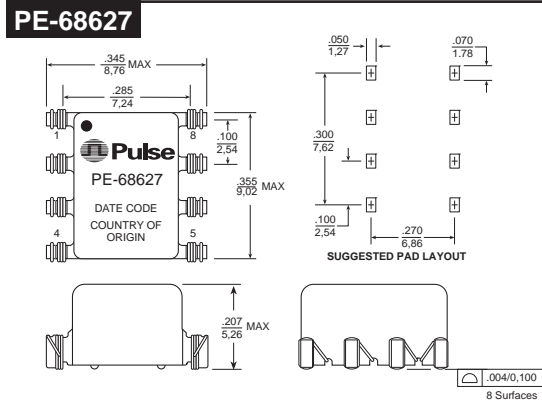
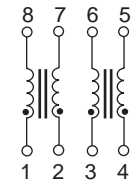
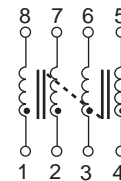

**Dimensions:** Inches  
mm

Unless otherwise specified,  
all tolerances are  $\pm .010$   
0,25

**Weight** . . . . . 0.3 grams  
**Tape & Reel** . . . . . 1500/reel  
**Tube** . . . . . 55/tube

**PE-68627**

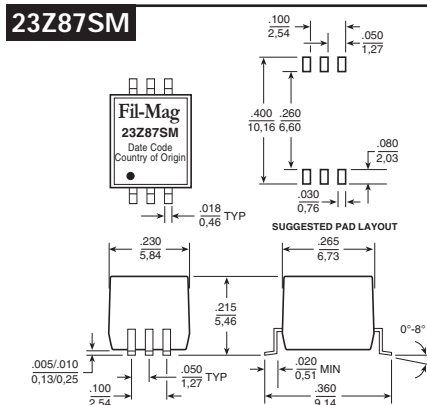
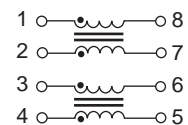

**Dimensions:** Inches  
mm

Unless otherwise specified,  
all tolerances are  $\pm .005$   
0,13

**Weight** . . . . . 0.5 grams  
**Tape & Reel** . . . . . 750/reel  
**Tube** . . . . . 100/tube

**23Z87SM**



# SURFACE MOUNT COMMON MODE CHOKES

Suited for LAN and Telecom Applications



Mechanical

Schematic

## 23Z104SM

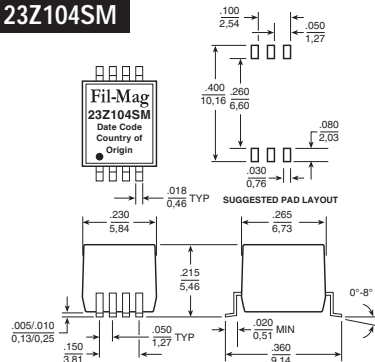

Dimensions:  $\frac{\text{Inches}}{\text{mm}}$

Unless otherwise specified,  
all tolerances are  $\pm .005$   
0,13

Weight . . . . . 0.5 grams

Tape & Reel . . . . . 750/reel

Tube . . . . . 100/tube

## 23Z104SM

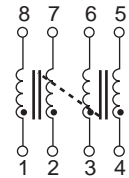

## 23Z105SM, 23Z106SM

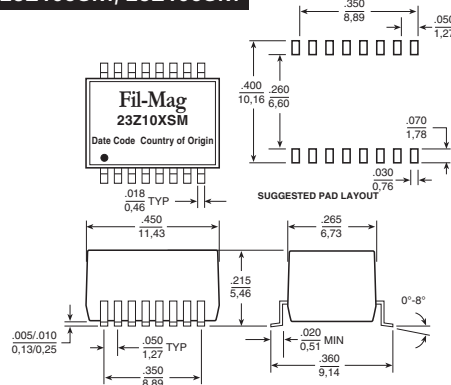

Dimensions:  $\frac{\text{Inches}}{\text{mm}}$

Unless otherwise specified,  
all tolerances are  $\pm .005$   
0,13

23Z105SM 23Z106SM

Weight . . . . . 0.8 grams . . . . . 1.0 grams

Tape & Reel . . . . . 750/reel . . . . . 750/reel

Tube . . . . . 50/tube . . . . . 50/tube

## 23Z105SM

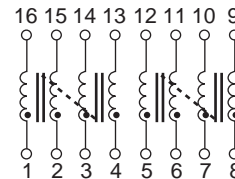

## 23Z106SM

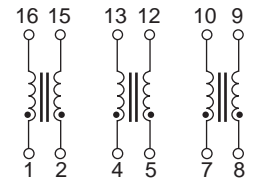

## 23Z109SM

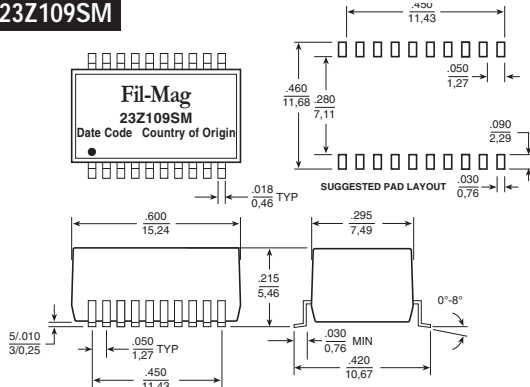

Dimensions:  $\frac{\text{Inches}}{\text{mm}}$

Unless otherwise specified,  
all tolerances are  $\pm .005$   
0,13

Weight . . . . . 1.3 grams

Tape & Reel . . . . . 500/reel

Tube . . . . . 38/tube

## 23Z109SM

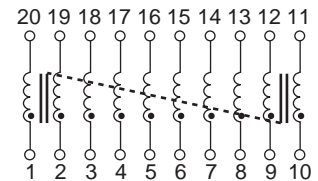

## 23Z4000SMD

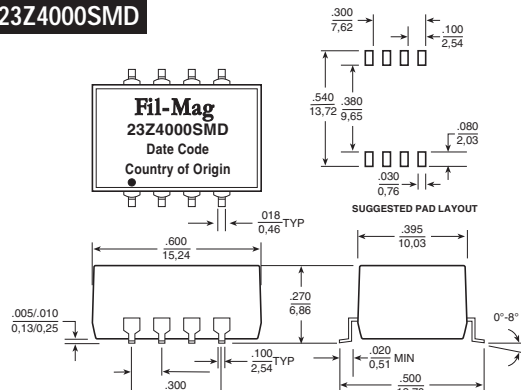

Dimensions:  $\frac{\text{Inches}}{\text{mm}}$

Unless otherwise specified,  
all tolerances are  $\pm .005$   
0,13

Weight . . . . . 2.1 grams

Tape & Reel . . . . . 350/reel

Tube . . . . . 38/tube

## 23Z4000SMD

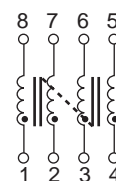

# SURFACE MOUNT COMMON MODE CHOKES

Suited for LAN and Telecom Applications



## Mechanical

## Schematic

### T8003

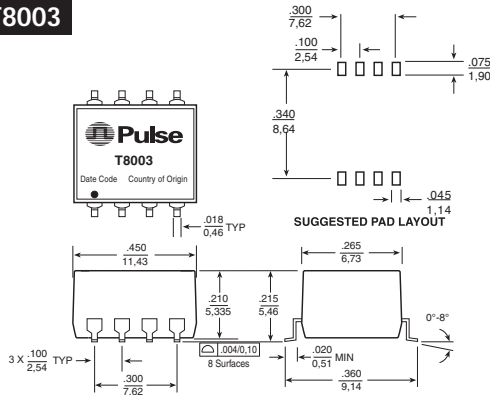

Dimensions: Inches  
mm

Unless otherwise specified,  
all tolerances are  $\pm .005$ -  
0,13

Weight . . . . . 0.84 grams  
Tape & Reel . . . . . 750/reel  
Tube . . . . . 100/tube

### T8003

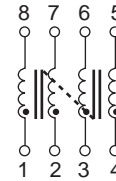

### T8055

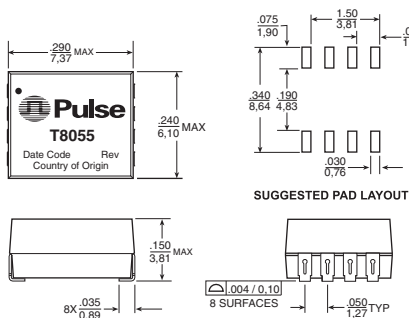

Dimensions: Inches  
mm

Unless otherwise specified,  
all tolerances are  $\pm .010$ -  
0,25

Weight . . . . . 0.2 grams  
Tape & Reel . . . . . 1750/reel  
Tube . . . . . 80/tube

### T8055

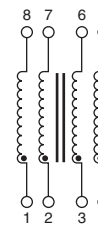

### B4003

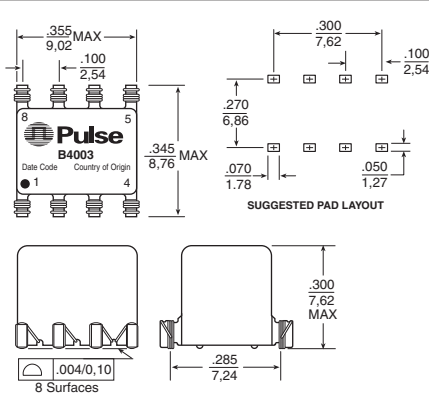

Dimensions: Inches  
mm

Unless otherwise specified,  
all tolerances are  $\pm .010$ -  
0,25

Weight . . . . . 1.0 grams  
Tape & Reel . . . . . 425/reel  
Tube . . . . . 50/tube

### B4003

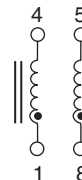

### T8008

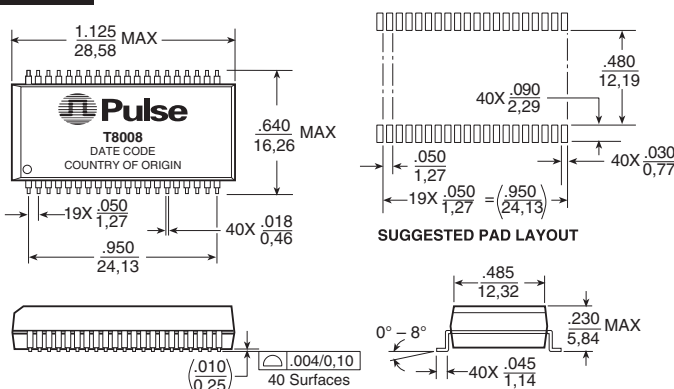

Dimensions: Inches  
mm

Unless otherwise specified,  
all tolerances are  $\pm .010$ -  
0,25

Weight . . . . . 4.0 grams  
Tape & Reel . . . . . 250/reel  
Tube . . . . . 15/tube

### T8008

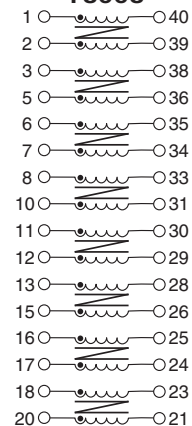

NOTE: The common mode test circuit for surface mount is the same as for through hole and is on the back page.

# THROUGH HOLE COMMON MODE CHOKES

Suited for LAN and Telecom Applications

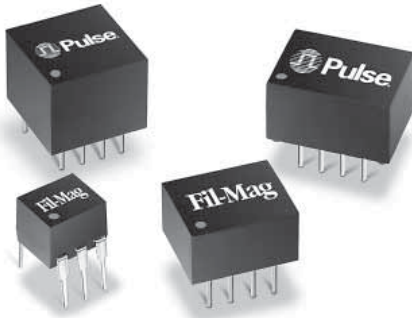

- Reduces radiated EMI emissions
- Filters common mode noise for EMI reduction
- Common mode attenuation from 100 kHz to 1 GHz
- Tube packaging available for through hole parts

### Electrical Specifications @ 25°C

Part Number	No. of Lines	Primary Inductance OCL (μH MIN)	Common Mode Attenuation (dB TYP)								DCR (Ω MAX)	Page Number Mech & Schem	
			100 kHz	1 MHz	10 MHz	30 MHz	50 MHz	100 MHz	300 MHz	500 MHz			1 GHz
PE-65944	2	24	1	14	28	32	33	28	13	5	—	0.30	8
PE-67531	2	140	14	34	45	49	50	47	38	32	25	0.60	9
B2005	2	9000	47	47	41	30	22	33	21	15	15	1.0	10
PE-65554	4	24	—	21	32	38	39	34	24	13	—	0.30	8
PE-68002	4	68	7	24	37	41	42	40	31	27	—	0.35	9
23Z104	4	85	8	23	29	29	28	25	17	11	—	0.20	10
PE-67539	4	140	14	33	44	48	48	43	33	28	19	0.60	9
PE-65542	4	1000	28	41	42	32	22	—	—	—	—	0.70	8
PT5039	4	3600	42	43	42	32	27	17	15	9	13	0.50	8
J0010D11	4	—	9	13	32	35	35	29	13	24	19	0.50	10
PE-65950	4	4700±30%	40	51	37	28	23	20	—	—	—	1.00	8
PE-65541	4	6000	44	54	33	32	29	—	—	—	—	1.40	8
PE-68613	4	3290	40	51	37	28	23	20	—	—	—	1.00	10

### Mechanical

### Schematic

#### PE-65541, PE-65542, PE-65950

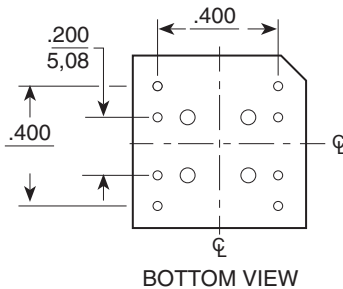
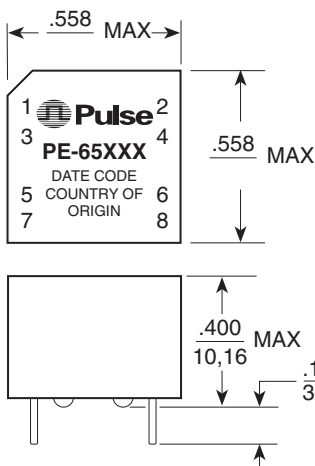

Dimensions: Inches \_\_\_\_\_  
mm \_\_\_\_\_  
Unless otherwise specified,  
all tolerances are ± .010  
0,25

Weight . . . . . 0.38 grams  
Tube . . . . . 35/tube

**PE-65541**  
**PE-65542**  
**PE-65950**

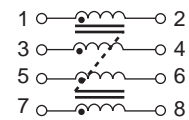

# THROUGH HOLE COMMON MODE CHOKES

Suited for LAN and Telecom Applications



Mechanical

Schematic

## PE-65554

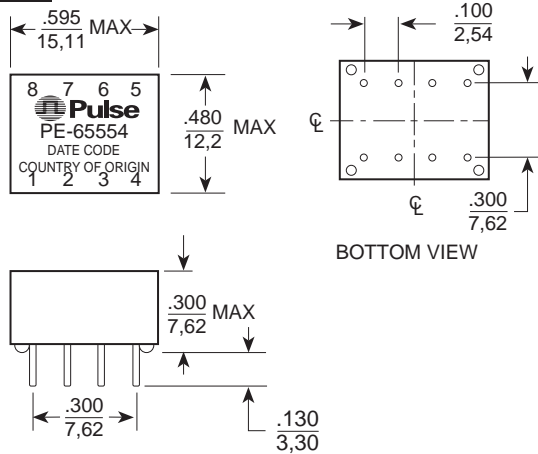

Dimensions:  $\frac{\text{Inches}}{\text{mm}}$   
Unless otherwise specified,  
all tolerances are  $\pm \frac{.010}{0,25}$

Weight . . . . . 2.5 grams  
Tube . . . . . 35/tube

## PE-65554

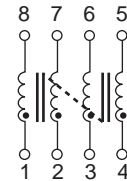

## PT5039

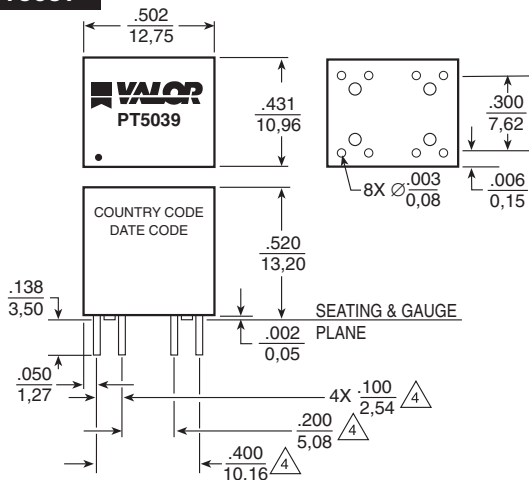

Dimensions:  $\frac{\text{Inches}}{\text{mm}}$   
Unless otherwise specified,  
all tolerances are  $\pm \frac{.010}{0,25}$

Weight . . . . . 2.5 grams  
Tube . . . . . 35/tube

## PT5039

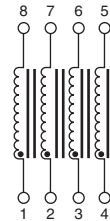

## PE-65944

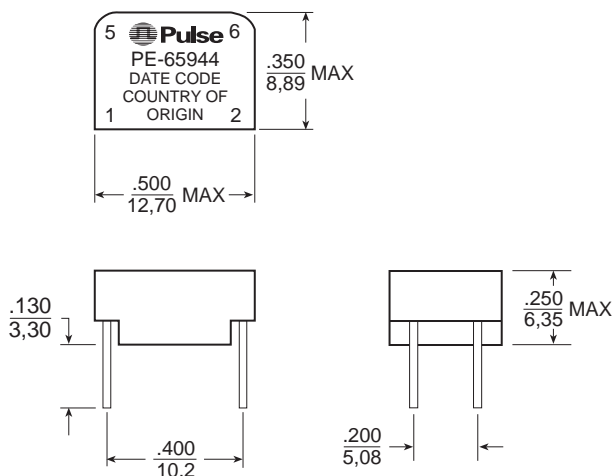

Dimensions:  $\frac{\text{Inches}}{\text{mm}}$   
Unless otherwise specified,  
all tolerances are  $\pm \frac{.010}{0,25}$

Weight . . . . . 1.07 grams  
Tube . . . . . 30/tube

## PE-65944





# THROUGH HOLE COMMON MODE CHOKES

Suited for LAN and Telecom Applications



Mechanical

Schematic

## PE-67539

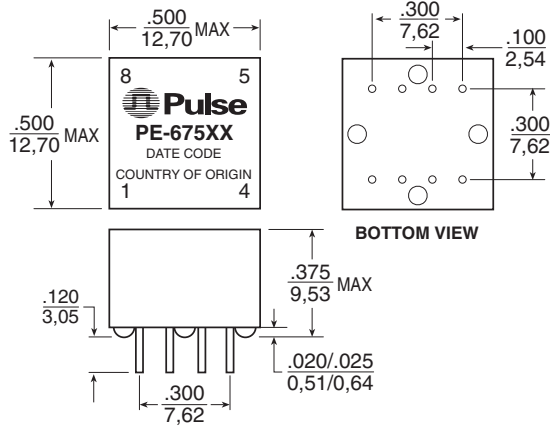

Dimensions:  $\frac{\text{Inches}}{\text{mm}}$   
Unless otherwise specified,  
all tolerances are  $\pm \frac{.010}{0,25}$

Weight . . . . . 2.4 grams  
Tube . . . . . 40/tube

## PE-67539

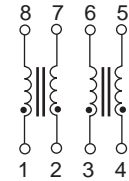

## PE-67531

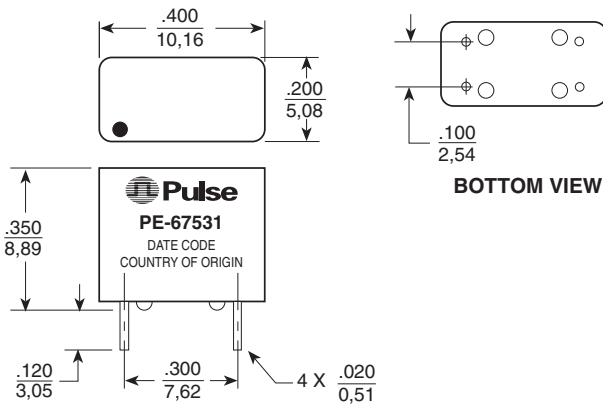

Dimensions:  $\frac{\text{Inches}}{\text{mm}}$   
Unless otherwise specified,  
all tolerances are  $\pm \frac{.010}{0,25}$

Weight . . . . . 0.76 grams  
Tube . . . . . 40/tube

## PE-67531



## PE-68002

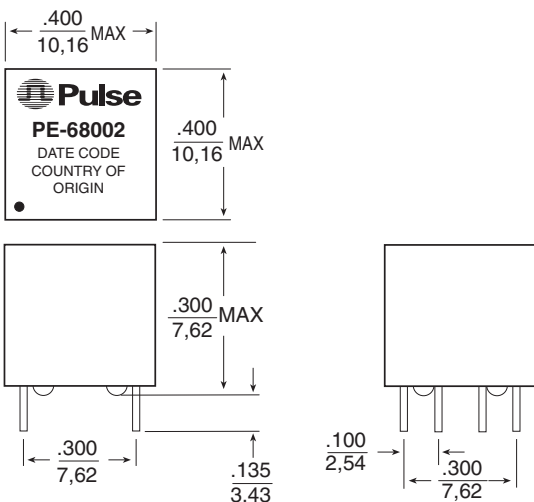

Dimensions:  $\frac{\text{Inches}}{\text{mm}}$   
Unless otherwise specified,  
all tolerances are  $\pm \frac{.010}{0,25}$

Weight . . . . . 1.4 grams  
Tube . . . . . 50/tube

## PE-68002

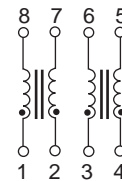

# THROUGH HOLE COMMON MODE CHOKES

Suited for LAN and Telecom Applications



## Mechanical

## Schematic

### B2005

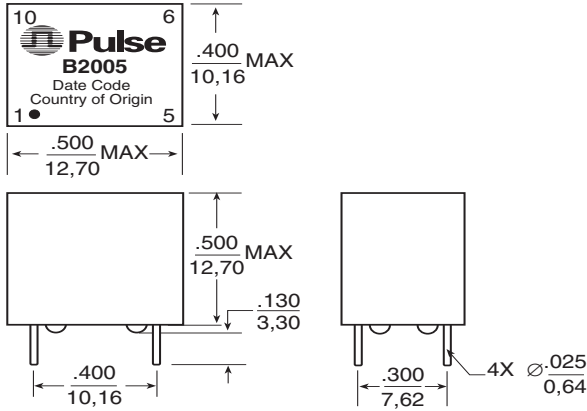

Dimensions:  $\frac{\text{Inches}}{\text{mm}}$   
Unless otherwise specified,  
all tolerances are  $\pm \frac{.005}{0,13}$

Weight . . . . . 3.7 grams  
Tube . . . . . 40/tube

### B2005



### 23Z104

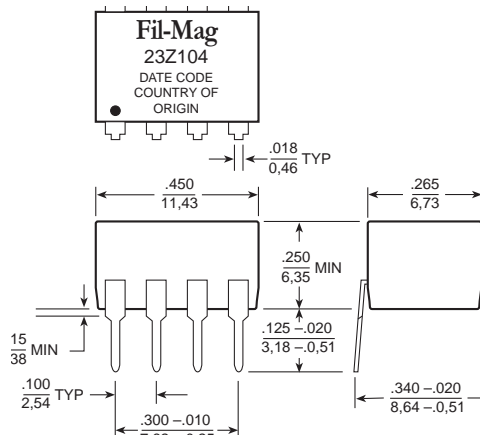

Dimensions:  $\frac{\text{Inches}}{\text{mm}}$   
Unless otherwise specified,  
all tolerances are  $\pm \frac{.005}{0,13}$

Weight . . . . . 1.0 grams  
Tube . . . . . 50/tube

### 23Z104

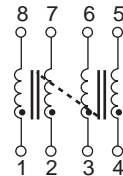

### PE-68613

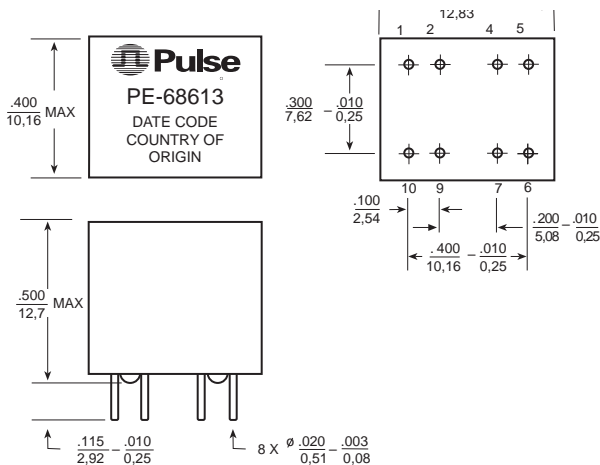

Dimensions:  $\frac{\text{Inches}}{\text{mm}}$   
Unless otherwise specified,  
all tolerances are  $\pm \frac{.005}{0,127}$

Weight . . . . . 3.5 grams  
Tube . . . . . 40/tube

### PE-68613

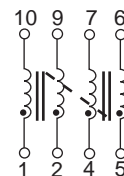

# THROUGH HOLE COMMON MODE CHOKES

Suited for LAN and Telecom Applications



## J0010D11 - Filtered Connector

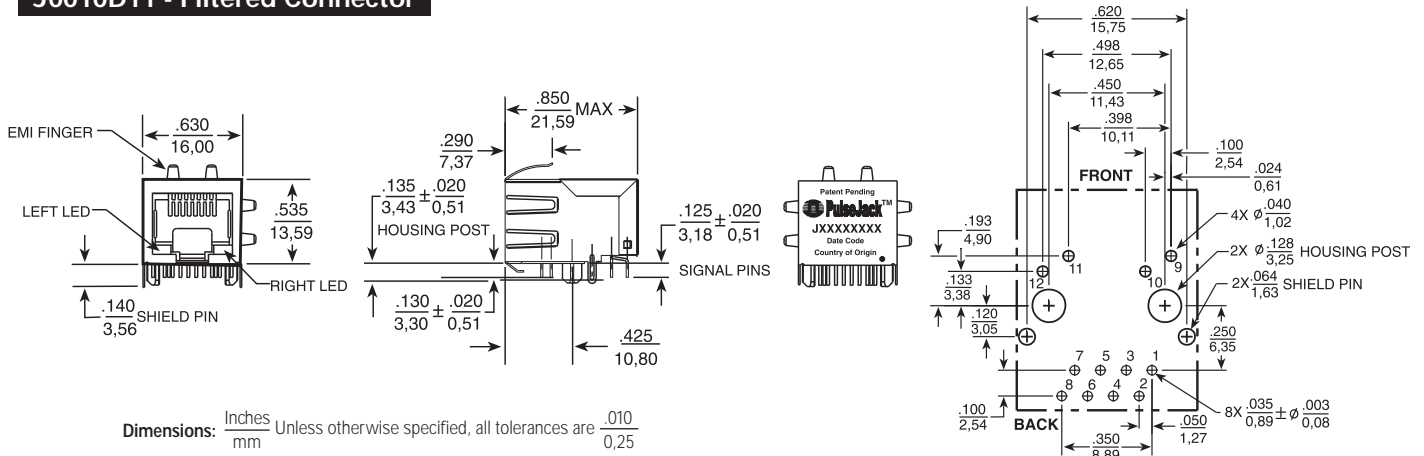

## Common Mode Test Circuit for Surface Mount and Through Hole

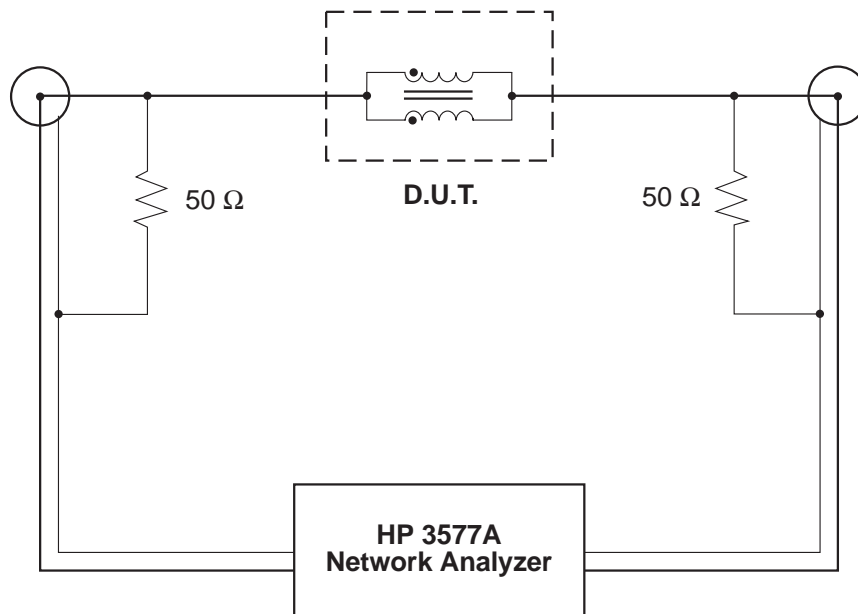

### Test Notes:

1. Network analyzer calibrated to compensate for 50  $\Omega$  resistors.
2. All windings on a core are connected in parallel for the test.
3. For multi-core chokes, test data is for one core only. The windings on the other core(s) are left unconnected (i.e. open).

### For More Information:

Pulse Worldwide Headquarters	Pulse Europe	Pulse China Headquarters	Pulse North China	Pulse South Asia	Pulse North Asia
12220 World Trade Dr. San Diego, CA 92128 U.S.A.	Einsteinstrasse 1 D-71083 Herrenberg Germany	B402, Shenzhen Academy of Aerospace Technology Bldg. 10th Kejinan Rd. High-Tech Zone Nanshan District Shenzhen, PR China 518057	Room 1503 XinYin Building No. 888 YiShan Rd. Shanghai 200233 China	135 Joo Seng Rd. #03-02 PM Industrial Bldg. Singapore 368363	No. 26, Kao Ching Rd. Yang Mei Chen Taoyuan Hsien Taiwan R. O. C.
<a href="http://www.pulseeng.com">www.pulseeng.com</a> Tel: 858 674 8100 Fax: 858 674 8262	Tel: 49 7032 7806 0 Fax: 49 7032 7806 135	TEL: 86 755 33966678 FAX: 86 755 33966700	Tel: 86 21 54643211/2 Fax: 86 21 54643210	TEL: 65 6287 8998 FAX: 65 6280 0080	Tel: 886 3 4643715 Fax: 886 3 4641911

Performance warranty of products offered on this data sheet is limited to the parameters specified. Data is subject to change without notice. Other brand and product names mentioned herein may be trademarks or registered trademarks of their respective owners.  
© Copyright, 2009. Pulse Engineering, Inc. All rights reserved.

## X-ON Electronics

Largest Supplier of Electrical and Electronic Components

*Click to view similar products for [Common Mode Chokes / Filters](#) category:*

*Click to view products by [Pulse manufacturer](#):*

Other Similar products are found below :

[74279408](#) [PE-62911NL](#) [PE-64683](#) [ST6118T-R](#) [T8114NLT](#) [RD5122-10-6M0](#) [TCM0806G-350-2P-T](#) [TCM0806G-650-2P-T](#) [IND-0110](#)  
[UAL21V07012500](#) [UAL21VR0802000](#) [UAL24VR06500CH](#) [UALSC023000000](#) [UALSC1020JH000](#) [UALSC1520JH000](#)  
[UALSU16VD30030](#) [UALSU16VD40010](#) [UALSU9H0305000](#) [UALSU9HF060300](#) [UALSU9VD070100](#) [36-00037](#) [5701610000](#)  
[UALW21HS072450](#) [UALSU9VD070400](#) [UALSU9HF050500](#) [UALSU9H0208000](#) [UALSCF25081300](#) [UAL24VK06450CH](#)  
[PLT10HH501100PNB](#) [PLT10HH401100PNB](#) [PLT10HH1026R0PNB](#) [PE-67531](#) [EXC-X4CH120X](#) [TLH10UB 113 0R5](#) [2752041447](#)  
[2752045447](#) [CMS3-11-R](#) [7351V](#) [CMF16-153131](#) [744252510](#) [T8116NLT](#) [FE2X10-4-2NL](#) [744253200](#) [744253101](#) [744252220](#) [TX8111NLT](#)  
[UAL30VR3500470](#) [CTX01-19077-R](#) [T8003NLT](#) [CTX01-13663](#)