

1.575 GHz GPS Ceramic Chip Antenna

On Ground type, ie. solid ground plane under antenna, top surface ground removal 10.80 x 6.25 mm.

Pulse Part Number: W3009

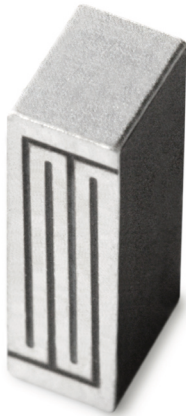

Features

- Omnidirectional radiation
- Low profile
- Compact size W x L x H (10 x 3.2 x 4 mm)
- Low weight (600 mg)
- Lead free materials
- Fully SMD compatible
- Lead free soldering compatible
- Tape and reel packing
- RoHS Compliant Product

Applications

- GPS L1 band
- 1.575 GHz

Electrical specifications @ +25 °C

Note: Electrical characteristics depend on test board (GP) size and antenna positioning on GP.

GPS

Typical performance (test board size 80 x 37 mm, PWB top surface ground removal area 10.80 x 6.25 mm)

Frequency Range [MHz]	RHCP Gain [dBic]	Linear Max Gain [dBi]	Efficiency [%] / [dB]	Return loss min. [dB]	Impedance [Ω]	Operating Temperature [°C]
1575.42 +/-10	0.7 (Peak) 0.3 (Band edges)	3 (Peak) 2.5 (Band edges)	80 / -1 (Peak) 75 / -1.25 (Band edges)	-10	50	-40 to +85

Pulse Finland Oy

Takatie 6
90440 Kempele, Finland
Tel: +358 207 935 500
Fax: +358 207 935 501

www.pulseeng.com/antennas



1.575 GHz GPS Ceramic Chip Antenna

On Ground type, ie. solid ground plane under antenna, top surface ground removal 10.80 x 6.25 mm.

Pulse Part Number: W3009

Terminal Configuration

Layout

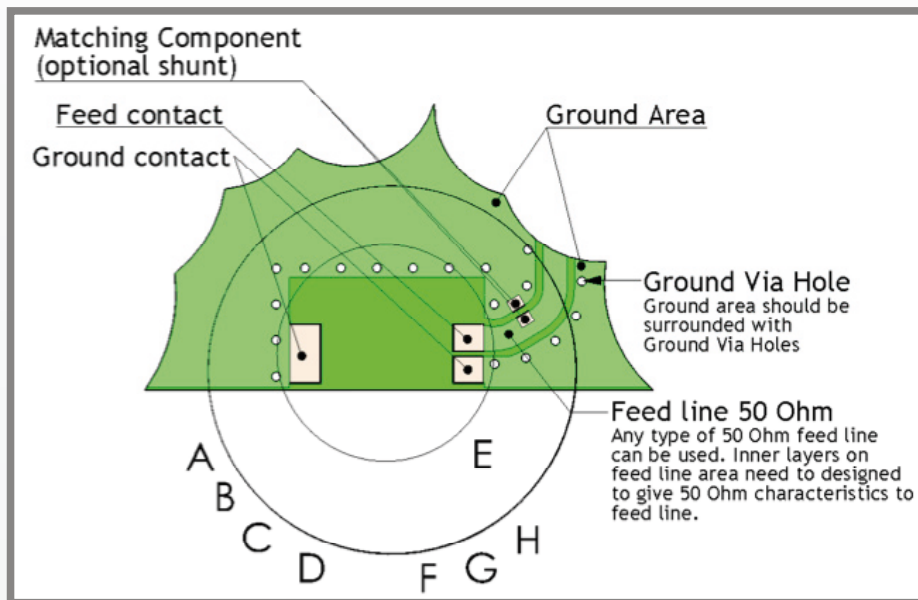

Pad dimensions in top copper

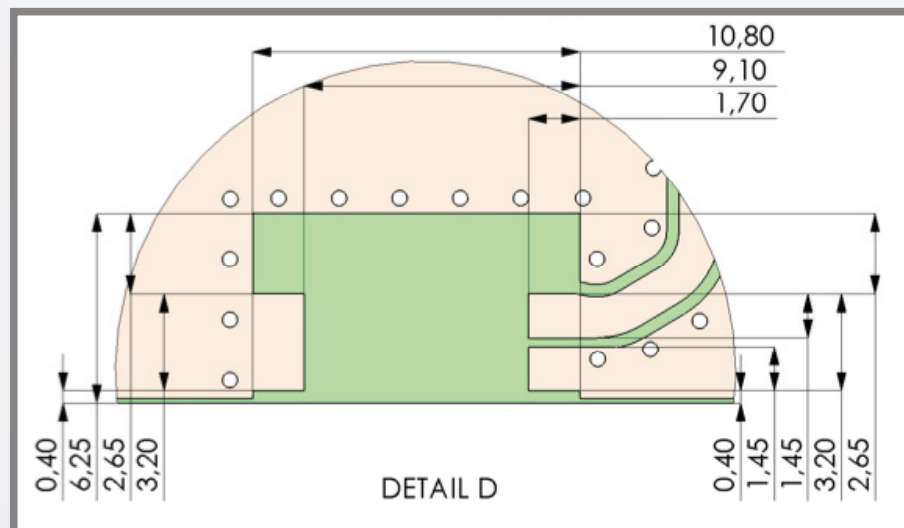

1.575 GHz GPS Ceramic Chip Antenna

On Ground type, ie. solid ground plane under antenna, top surface ground removal 10.80 x 6.25 mm.

Pulse Part Number: W3009

Terminal Configuration

Antenna

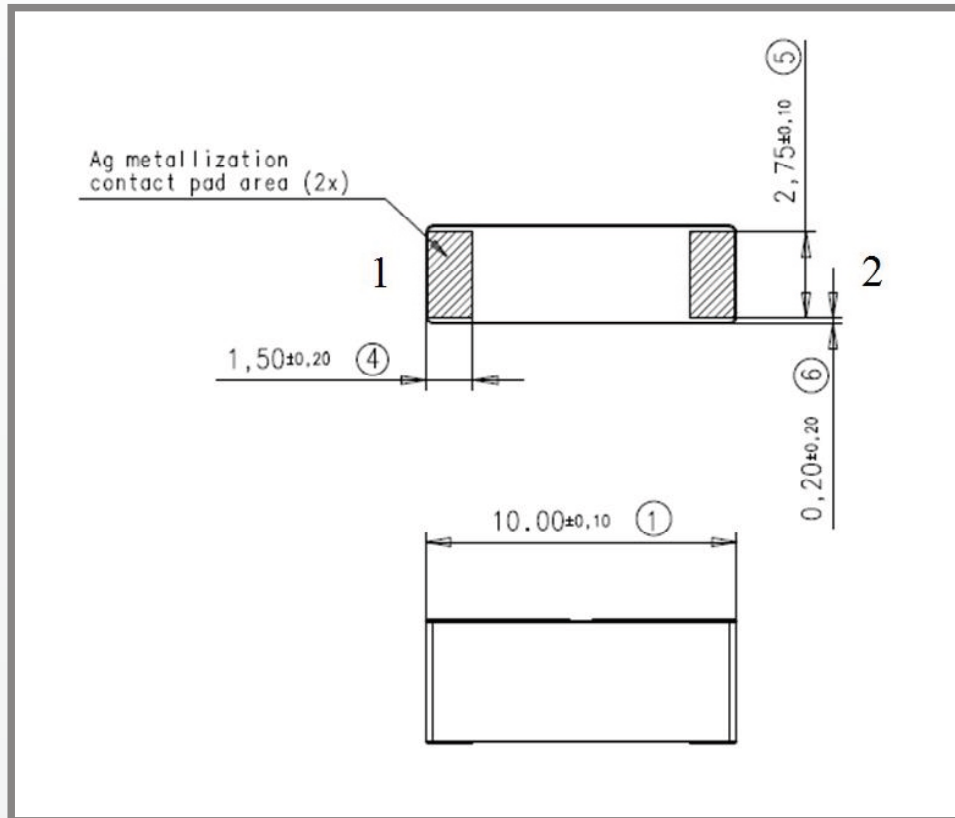

No.	Terminal Name	Terminal Dimensions
1	Feed / GND	1.50 x 2.75 mm
2	Feed / GND	1.50 x 2.75 mm

Antenna is symmetrical. Either of terminals 1 or 2 can be Feed / GND

Pulse Finland Oy

Takatie 6

90440 Kempele, Finland

Tel: +358 207 935 500

Fax: +358 207 935 501

www.pulseeng.com/antennas



1.575 GHz GPS Ceramic Chip Antenna

On Ground type, ie. solid ground plane under antenna, top surface ground removal 10.80 x 6.25 mm.

Pulse Part Number: W3009

Typical Electrical Characteristics (T=25 °C)

Measured on the 80 x 37 mm test board with matching circuit (2.2 pF shunt matching capacitor on feed).

Typical Return Loss S11/ impedance, free space efficiency and gain

GPS Ceramic Chip Antenna

25 May 2007 07:22:17

CH1Markers

- 1. -12.032 dB 1.56500 GHz
- 2. -20.839 dB 1.575.420 MHz
- 3. -11.637 dB 1.58500 GHz

CH1 S11 LOG

5 dB/REF 0 dB

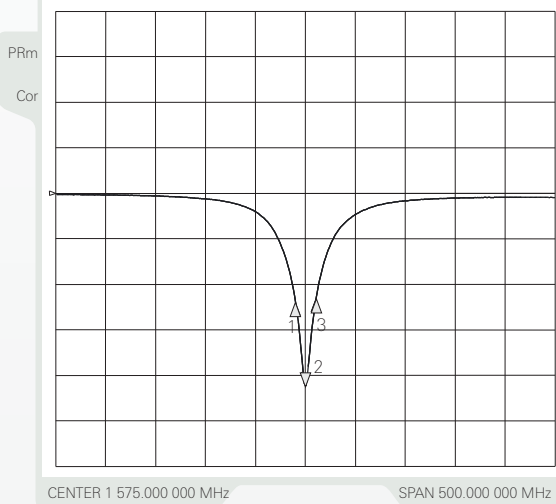

GPS Ceramic Chip Antenna

25 May 2007 07:23:38

- 1. 64.203 Ω 25.500 Ω 1.56500 GHz
- 2. 56.211 Ω -8.5977 Ω 11.750 pF
1.575.420 000 MHz
- 3. 33.688 Ω -17.396 Ω 1.58500 GHz

CH1 S11 1 U FS

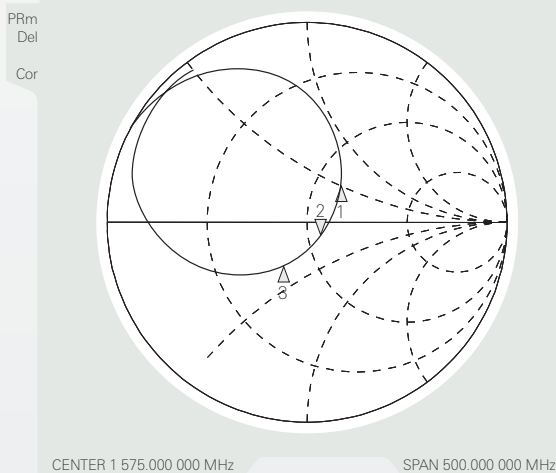

GPS OG 10 x 3.2 x 4 mm

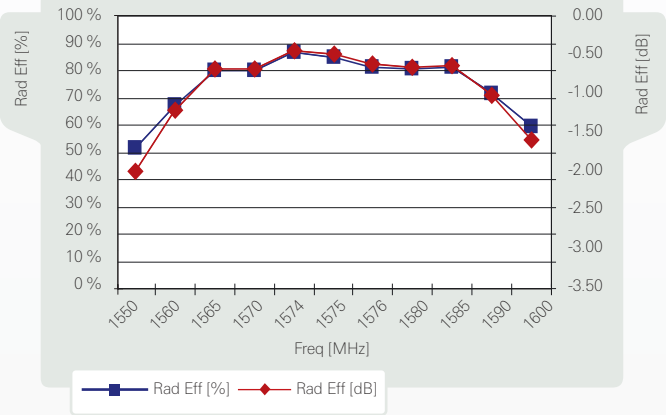

GPS OG 10 x 3.2 x 4 mm

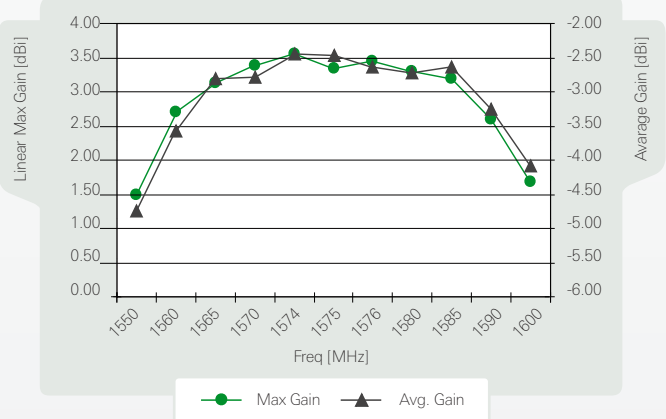

GPS OG 10 x 3.2 x 4 mm

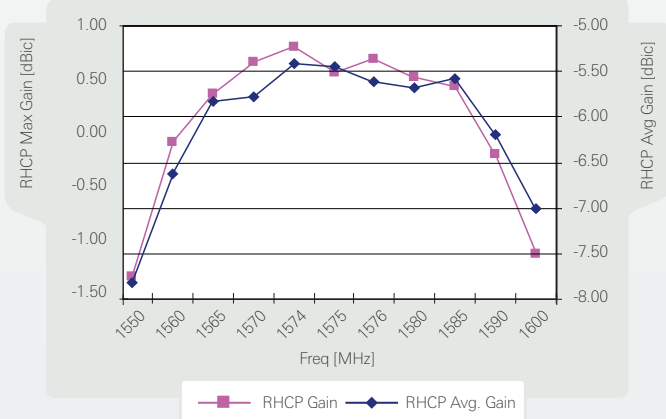

Pulse Finland Oy

Takatie 6
90440 Kempele, Finland
Tel: +358 207 935 500
Fax: +358 207 935 501
www.pulseeng.com/antennas



1.575 GHz GPS Ceramic Chip Antenna

On Ground type, ie. solid ground plane under antenna, top surface ground removal 10.80 x 6.25 mm.

Pulse Part Number: W3009

Typical Free Space Radiation Patterns

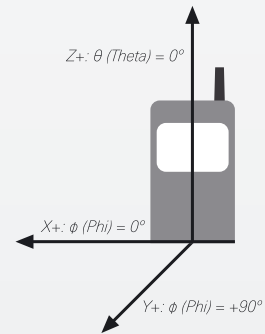
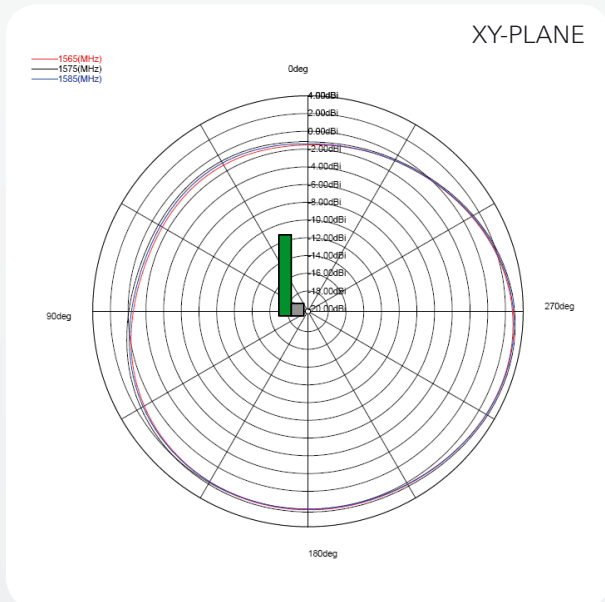
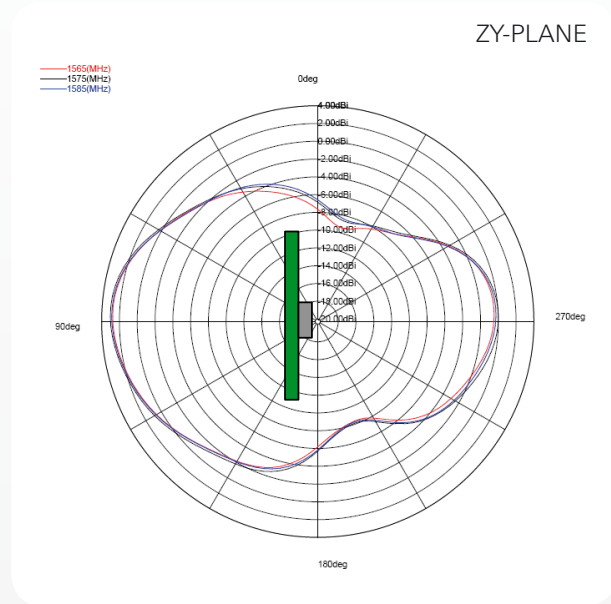
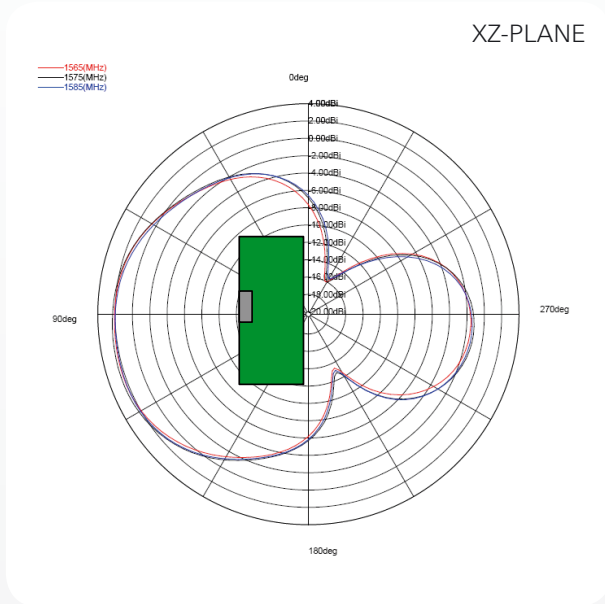

1.575 GHz GPS Ceramic Chip Antenna

On Ground type, ie. solid ground plane under antenna, top surface ground removal 10.80 x 6.25 mm.

Pulse Part Number: W3009

W3009 GPS Antenna Packing

Packing form

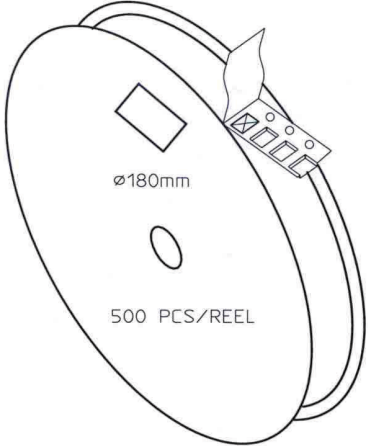
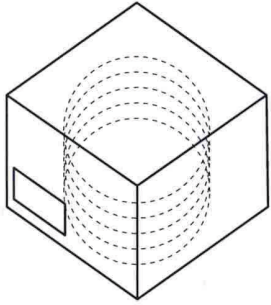
CARRIER TAPE H85-00158
width=24,00 depth=4.15
COVER TAPE H85-00159
width=21.20

LENGTH OF TAPE:

- Leader section: min 350 mm before component section
- Trailer section: min 40 mm after component section.

Empty part cavities at leader and trailer section of the tape must be sealed with top cover tape.

BOX H85-00128 (182x182x125)	1 pcs
- LABEL	1 pcs/BOX
REEL H85-00160 (D180, W28)	4 pcs
- REEL LABEL	1 pcs/REEL

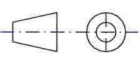
MATERIAL			
HANDLINGS			
		RATIO	DRWN 160107 PeHa H
			DGNER
			CHKD F
			APPRD E
PRODUCT H90-OY800-F01P01			APPRD BY D
			C
DENOMINATION PACKING FORM			B
			A
		VERSION	MOD/DATE/NAME

X-ON Electronics

Largest Supplier of Electrical and Electronic Components

Click to view similar products for [Antennas](#) category:

Click to view products by [Pulse](#) manufacturer:

Other Similar products are found below :

[GAN30084EU](#) [930-033-R](#) [GW17.07.0250E](#) [1513563-1](#) [EXE902SM](#) [APAMPG-117](#) [MAF94383](#) [W3908B0100](#) [W6102B0100](#) [YE572113-30RSMM](#) [108-00014-50](#) [66089-2406](#) [A09-F8NF-M](#) [A09-F5NF-M](#) [RGFRA1903041A1T](#) [W3593B0100](#) [W3921B0100](#) [SIMNA-868](#) [SIMNA-915](#) [SIMNA-433](#) [W1044](#) [W1049B090](#) [A75-001](#) [WTL2449CQ1-FRSMM](#) [CPL9C](#) [EXB148BN](#) [0600-00060](#) [TRA9020S3PBN-001](#) [GD5W-28P-NF](#) [MA9-7N](#) [GD53-25](#) [GD5W-21P-NF](#) [C37](#) [MAF94051](#) [MA9-5N](#) [EXD420PL](#) [B1322NR](#) [QWFTB120](#) [MAF94271](#) [MAF94300](#) [GPSMB301](#) [FG4403](#) [AO-AGSM-OM54](#) [5200232](#) [MIKROE-2349](#) [WCM.01.0111](#) [MIKROE-2393](#) [MIKROE-2352](#) [MIKROE-2350](#) [MAF94153](#)