

**Description:** LTE Primary + GNSS FPC Antenna

**Series:** Gemini

**PART NUMBER:** W3906B0100

### Features:

- 2G / 3G / 4G Primary Ant for MiMo
- 698-3600MHz
- Used as pair for W3907B0100
- Global LTE Bands:
  - B1-B23, B25-B29, B33-B42
  - N.A.; Europe, Asia (incl. Jap.)
- GNSS (GPS, Galileo, Glonass)
- Foldable for tight spaces

### Applications:

- Challenging RF Environments Demanding:
  - Highest Peak Gain
  - Lowest ECC (Envelope Correlation Coeff.).
- Matched to Radio Modules from:
  - Sierra Wireless, Telit, Huawei, Gemalto, uBlox, ZTE, and others.
- Security, Video, Graphics
- IoT, SmartGrid, Meters, Remote Monitoring, Sensor Networks
- Transportation, Tracking



All dimensions are in mm / inches

Issue: 2029

In the effort to improve our products, we reserve the right to make changes judged to be necessary.

CONFIDENTIAL AND PROPRIETARY INFORMATION

This document contains confidential and proprietary information of Pulse Electronics, Inc. (Pulse) and is protected by copyright, trade secret and other state and federal laws. Its receipt or possession does not convey any rights to reproduce, disclose its contents, or to manufacture, use or sell anything it may describe. Reproduction, disclosure or use without specific written authorization of Pulse is strictly forbidden.

For more information:

Pulse Worldwide Headquarters  
15255 Innovation Drive #100  
San Diego, CA 92128  
USA  
Tel: 1-858-674-8100

Pulse/Larsen Antennas  
18110 SE 34<sup>th</sup> St Bldg 2 Suite 250  
Vancouver, WA 98683  
USA  
Tel: 1-360-944-7551

Europe Headquarters  
Pulse GmbH & Do, KG  
Zeppelinstrasse 15  
Herrenberg, Germany  
Tel: 49 7032 7806 0

Pulse (Suzhou) Wireless Products Co, Inc.  
99 Huo Ju Road(#29 Bldg,4<sup>th</sup> Phase  
Suzhou New District  
Jiangsu Province, Suzhou 215009 PR China  
Tel: 86 512 6807 9998



**Description:** LTE Primary + GNSS FPC Antenna

**Series:** Gemini

**PART NUMBER:** W3906B0100

**ELECTRICAL SPECIFICATIONS**

LTE :

Frequency	698-960/1427.9-1510.9/1559-1610/ 1695-2200/2300-2700/3400-3600 MHz
Nominal Impedance	50Ω
Return loss(698-960MHz)	-6dB
Return loss(1427.9-1510.9/1559-1610/ 1695-2200/2300-2700/3400-3600MHz)	-7.5dB
Isolation	-10dB
Average Total Efficiency (698-960MHz)	54%
Average Total Efficiency (1427.9-1510.9MHz)	59%
Average Total Efficiency (1559-1610MHz)	59%
Average Total Efficiency (1695-2200MHz)	64%
Average Total Efficiency (2300-2700MHz)	69%
Average Total Efficiency (3400-3600MHz)	64%

Issue: 2029

In the effort to improve our products, we reserve the right to make changes judged to be necessary.

CONFIDENTIAL AND PROPRIETARY INFORMATION

This document contains confidential and proprietary information of Pulse Electronics, Inc. (Pulse) and is protected by copyright, trade secret and other state and federal laws. Its receipt or possession does not convey any rights to reproduce, disclose its contents, or to manufacture, use or sell anything it may describe. Reproduction, disclosure or use without specific written authorization of Pulse is strictly forbidden.

For more information:

Pulse Worldwide Headquarters  
15255 Innovation Drive #100  
San Diego, CA 92128  
USA  
Tel:1-858-674-8100

Pulse/Larsen Antennas  
18110 SE 34<sup>th</sup> St Bldg 2 Suite 250  
Vancouver, WA 98683  
USA  
Tel: 1-360-944-7551

Europe Headquarters  
Pulse GmbH & Do, KG  
Zeppelinstrasse 15  
Herrenberg, Germany  
Tel: 49 7032 7806 0

Pulse (Suzhou) Wireless Products Co, Inc.  
99 Huo Ju Road(#29 Bldg,4<sup>th</sup> Phase  
Suzhou New District  
Jiangsu Province, Suzhou 215009 PR China  
Tel: 86 512 6807 9998



**Description:** LTE Primary + GNSS FPC Antenna

**Series:** Gemini

**PART NUMBER:** W3906B0100

**ELECTRICAL SPECIFICATIONS**

Peak Gain (698-960MHz)	2.7dBi
Peak Gain (1427.9-1510.9MHz)	1.5dBi
Peak Gain (1559-1610MHz)	1.6dBi
Peak Gain (1695-2200MHz)	3.2dBi
Peak Gain (2300-2700MHz)	3.6dBi
Peak Gain (3400-3600MHz)	4.0dBi

GNSS :

Frequency	1570-1610MHz
Nominal Impedance	50Ω
Return loss (1570-1610MHz)	-10dB
Average Total Efficiency (1570-1610MHz)	35%
Peak Gain (1570-1610MHz)	0.8dBi
Radiation Pattern	Omni
Polarization	Linear
Power withstanding	3W

(\* ) All RF parameters measured on 2mm thick PC plate

Issue: 2029

In the effort to improve our products, we reserve the right to make changes judged to be necessary.

CONFIDENTIAL AND PROPRIETARY INFORMATION

This document contains confidential and proprietary information of Pulse Electronics, Inc. (Pulse) and is protected by copyright, trade secret and other state and federal laws. Its receipt or possession does not convey any rights to reproduce, disclose its contents, or to manufacture, use or sell anything it may describe. Reproduction, disclosure or use without specific written authorization of Pulse is strictly forbidden.

For more information:

Pulse Worldwide Headquarters  
15255 Innovation Drive #100  
San Diego, CA 92128  
USA  
Tel:1-858-674-8100

Pulse/Larsen Antennas  
18110 SE 34<sup>th</sup> St Bldg 2 Suite 250  
Vancouver, WA 98683  
USA  
Tel: 1-360-944-7551

Europe Headquarters  
Pulse GmbH & Do, KG  
Zeppelinstrasse 15  
Herrenberg, Germany  
Tel: 49 7032 7806 0

Pulse (Suzhou) Wireless Products Co, Inc.  
99 Huo Ju Road(#29 Bldg,4<sup>th</sup> Phase  
Suzhou New District  
Jiangsu Province, Suzhou 215009 PR China  
Tel: 86 512 6807 9998



**Description:** LTE Primary + GNSS FPC Antenna

**Series:** Gemini

**PART NUMBER:** W3906B0100

### MECHANICAL SPECIFICATIONS

Overall Length	120.4x26.8mm
Weight	2.0g
Antenna Color / Material	BLACK FPC
Cable type	AWG#32 1.13MM
Connector type	I-PEX MHF 20278-112R-13 or compatible
Cable length (LTE)	93mm
Cable length (GPS)	93mm

### ENVIRONMENTAL SPECIFICATIONS

Operating Temperature	-40~+85° C
Storage Temperature	-40~+85° C
RoHS Compliant	Yes

Description: LTE Primary + GNSS FPC Antenna

Series: Gemini

PART NUMBER: W3906B0100

MECHANICAL DRAWING

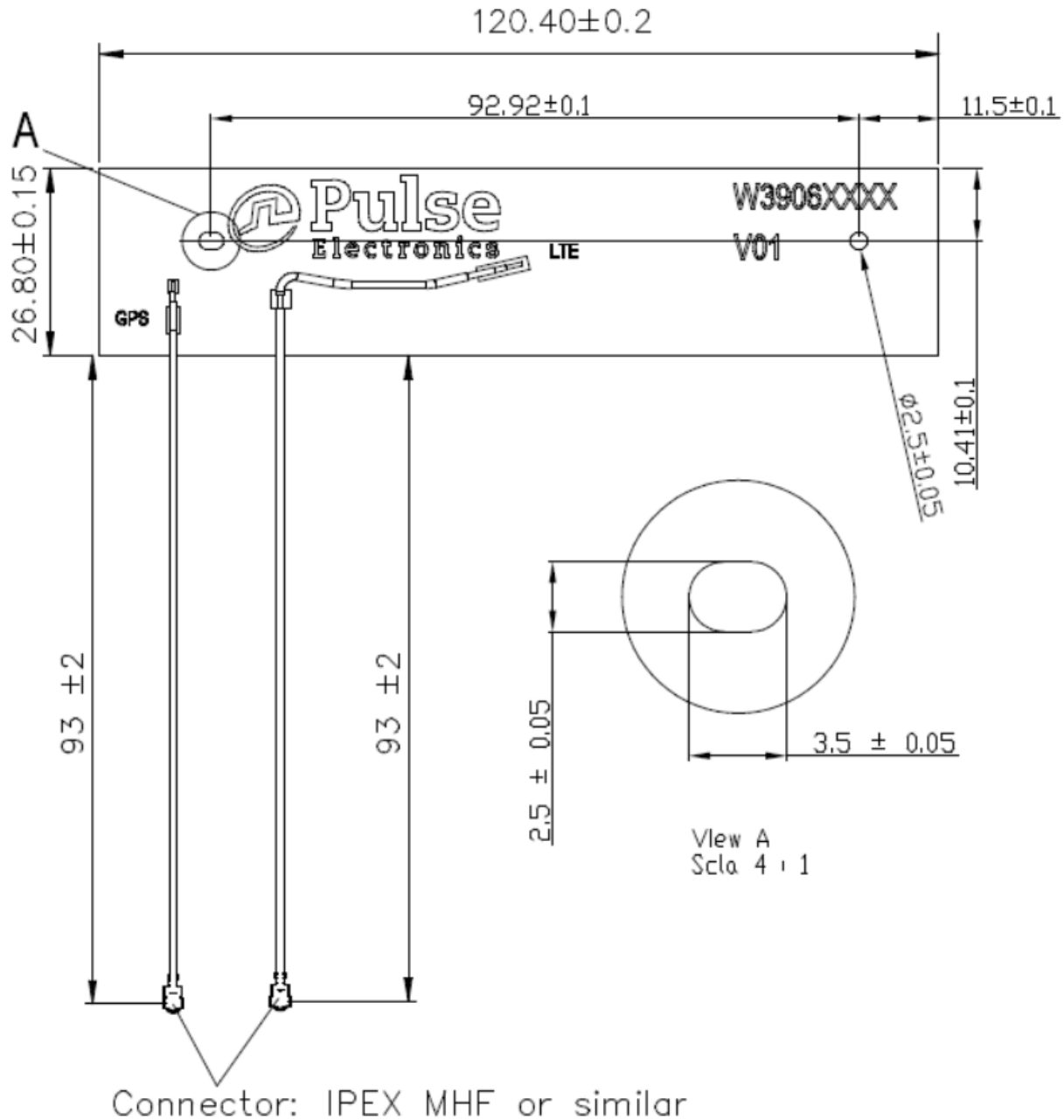

Unit: MM

Issue: 2029

In the effort to improve our products, we reserve the right to make changes judged to be necessary.

CONFIDENTIAL AND PROPRIETARY INFORMATION

This document contains confidential and proprietary information of Pulse Electronics, Inc. (Pulse) and is protected by copyright, trade secret and other state and federal laws. Its receipt or possession does not convey any rights to reproduce, disclose its contents, or to manufacture, use or sell anything it may describe. Reproduction, disclosure or use without specific written authorization of Pulse is strictly forbidden.

Description: LTE Primary + GNSS FPC Antenna

Series: Gemini

PART NUMBER: W3906B0100

CHARTS

Return Loss

LTE Return Loss

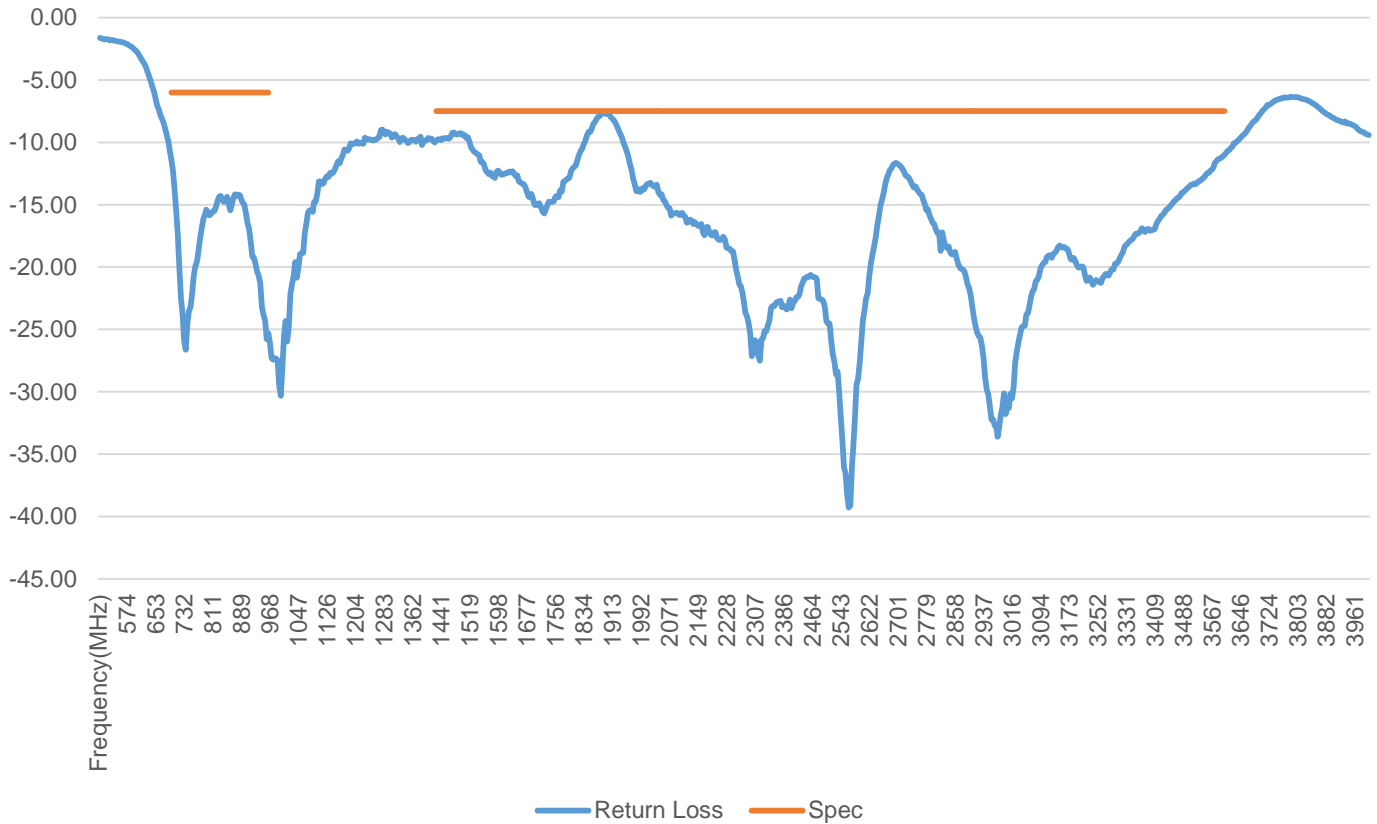

Issue: 2029

In the effort to improve our products, we reserve the right to make changes judged to be necessary.

CONFIDENTIAL AND PROPRIETARY INFORMATION

This document contains confidential and proprietary information of Pulse Electronics, Inc. (Pulse) and is protected by copyright, trade secret and other state and federal laws. Its receipt or possession does not convey any rights to reproduce, disclose its contents, or to manufacture, use or sell anything it may describe. Reproduction, disclosure or use without specific written authorization of Pulse is strictly forbidden.

**Description:** LTE Primary + GNSS FPC Antenna

**Series:** Gemini

**PART NUMBER:** W3906B0100

CHARTS

Return Loss

GNSS Return Loss

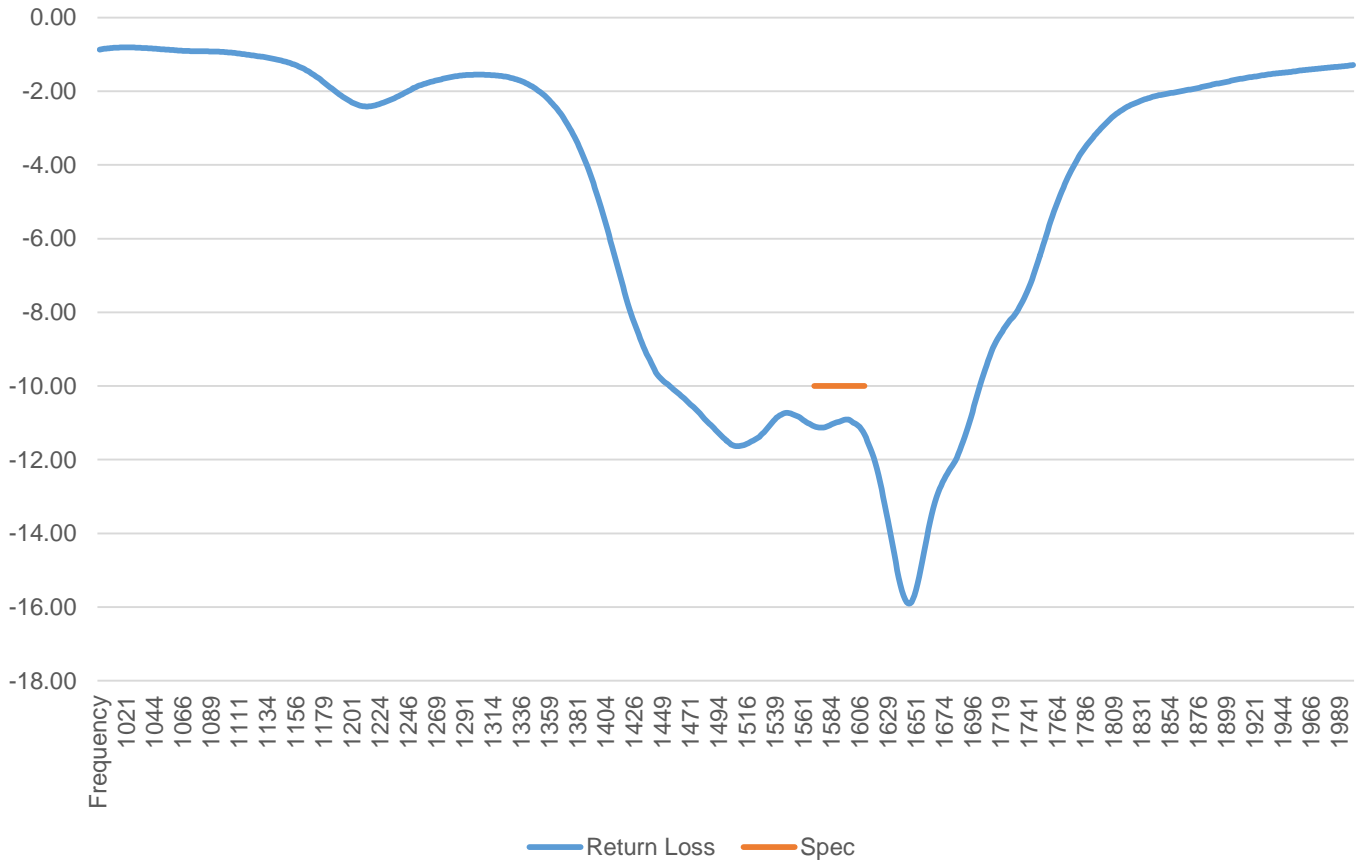

Issue: 2029

In the effort to improve our products, we reserve the right to make changes judged to be necessary.

CONFIDENTIAL AND PROPRIETARY INFORMATION

This document contains confidential and proprietary information of Pulse Electronics, Inc. (Pulse) and is protected by copyright, trade secret and other state and federal laws. Its receipt or possession does not convey any rights to reproduce, disclose its contents, or to manufacture, use or sell anything it may describe. Reproduction, disclosure or use without specific written authorization of Pulse is strictly forbidden.



Description: LTE Primary + GNSS FPC Antenna

Series: Gemini

PART NUMBER: W3906B0100

CHARTS

Isolation

LTE & GNSS Isolation

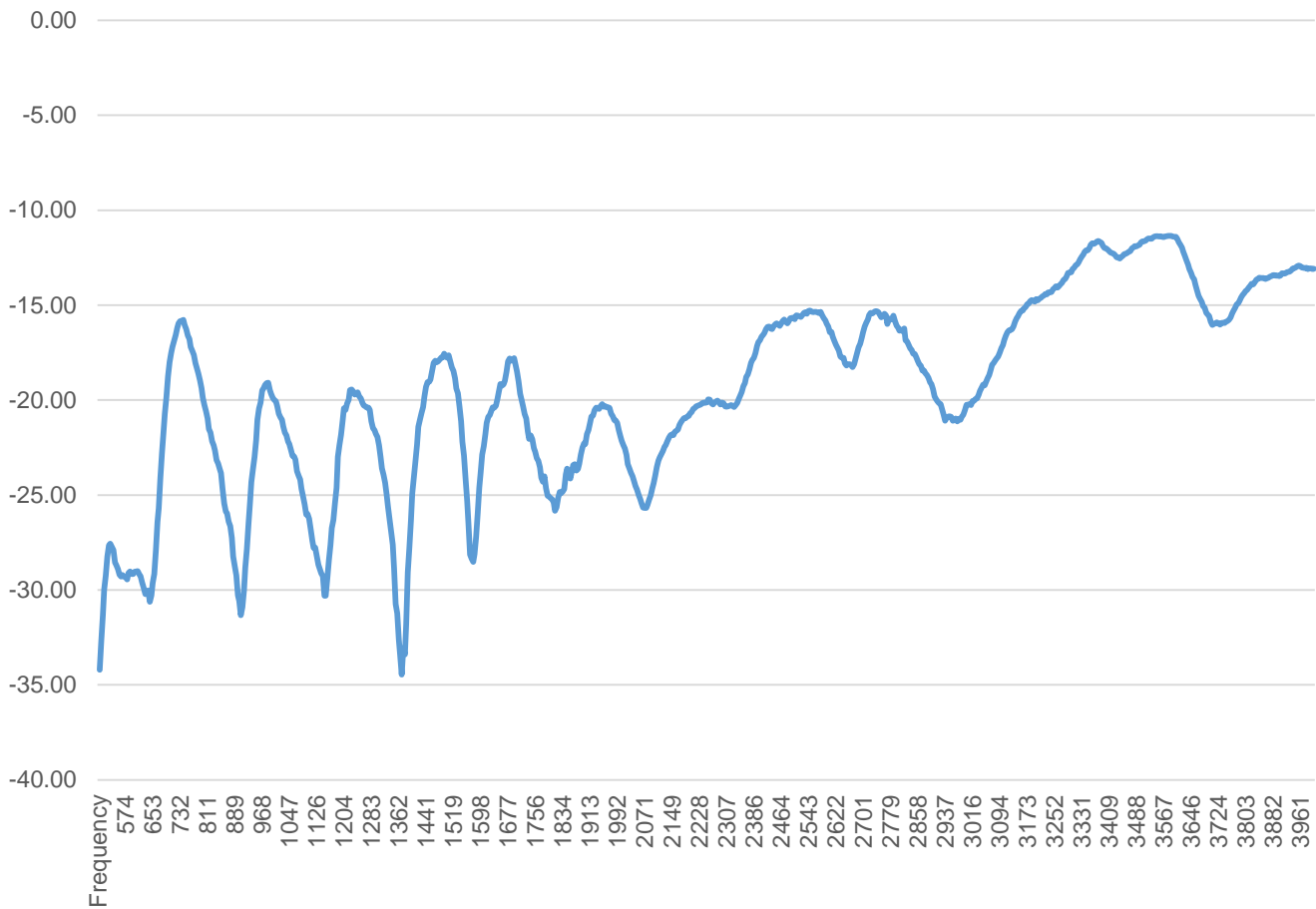

Issue: 2029

In the effort to improve our products, we reserve the right to make changes judged to be necessary.

CONFIDENTIAL AND PROPRIETARY INFORMATION

This document contains confidential and proprietary information of Pulse Electronics, Inc. (Pulse) and is protected by copyright, trade secret and other state and federal laws. Its receipt or possession does not convey any rights to reproduce, disclose its contents, or to manufacture, use or sell anything it may describe. Reproduction, disclosure or use without specific written authorization of Pulse is strictly forbidden.





**Description:** LTE Primary + GNSS FPC Antenna

**Series:** Gemini

**PART NUMBER:** W3906B0100

**CHARTS**

**Efficiency(%)**

**LTE Efficiency(%)**

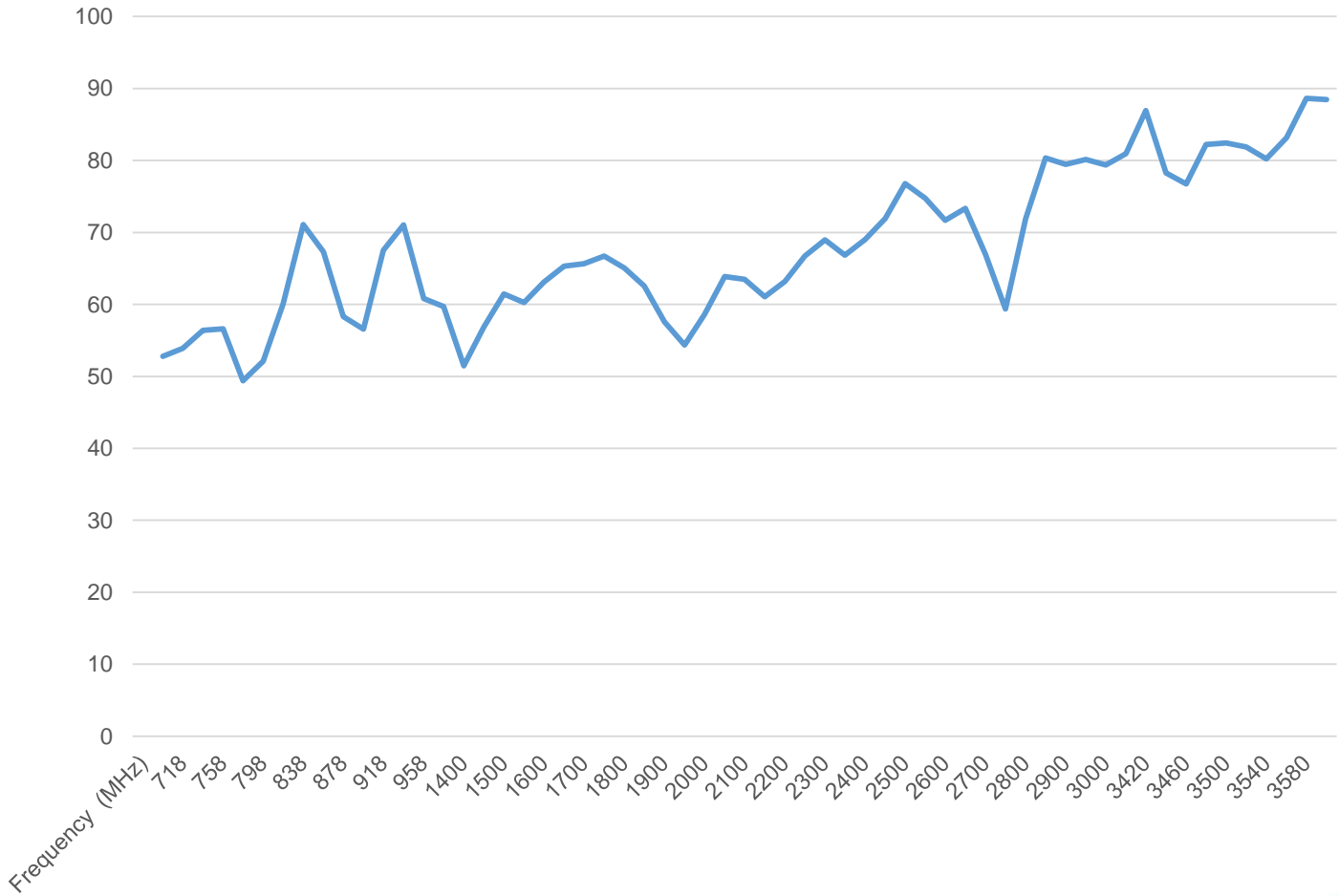

Issue: 2029

In the effort to improve our products, we reserve the right to make changes judged to be necessary.

CONFIDENTIAL AND PROPRIETARY INFORMATION

This document contains confidential and proprietary information of Pulse Electronics, Inc. (Pulse) and is protected by copyright, trade secret and other state and federal laws. Its receipt or possession does not convey any rights to reproduce, disclose its contents, or to manufacture, use or sell anything it may describe. Reproduction, disclosure or use without specific written authorization of Pulse is strictly forbidden.



**Description:** LTE Primary + GNSS FPC Antenna

**Series:** Gemini

**PART NUMBER:** W3906B0100

**CHARTS**

**Efficiency(%)**

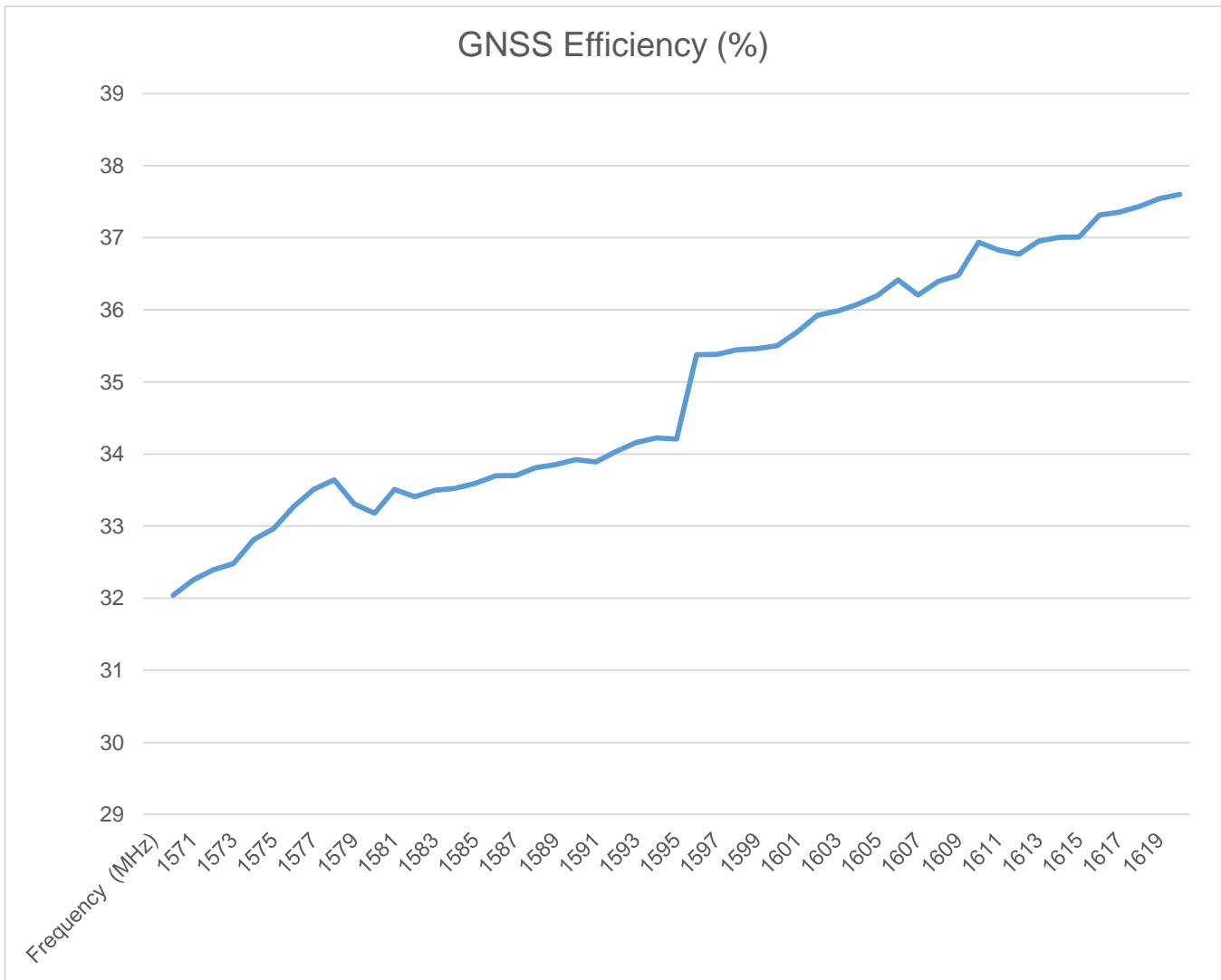

Issue: 2029

In the effort to improve our products, we reserve the right to make changes judged to be necessary.

CONFIDENTIAL AND PROPRIETARY INFORMATION

This document contains confidential and proprietary information of Pulse Electronics, Inc. (Pulse) and is protected by copyright, trade secret and other state and federal laws. Its receipt or possession does not convey any rights to reproduce, disclose its contents, or to manufacture, use or sell anything it may describe. Reproduction, disclosure or use without specific written authorization of Pulse is strictly forbidden.

**Description:** LTE Primary + GNSS FPC Antenna

**Series:** Gemini

**PART NUMBER:** W3906B0100

**CHARTS**

**Peak Gain(dBi)**

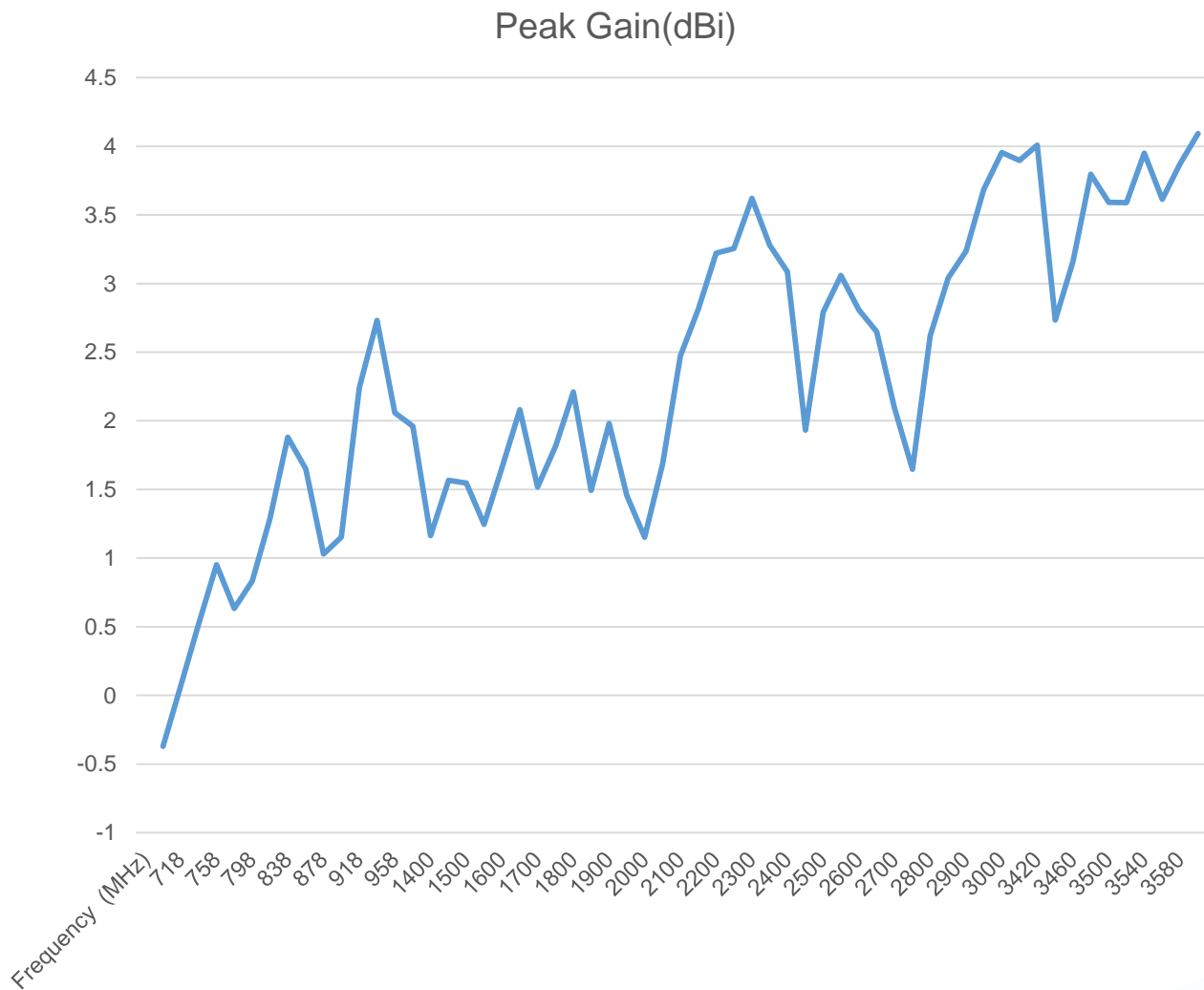

Issue: 2029

In the effort to improve our products, we reserve the right to make changes judged to be necessary.

CONFIDENTIAL AND PROPRIETARY INFORMATION

This document contains confidential and proprietary information of Pulse Electronics, Inc. (Pulse) and is protected by copyright, trade secret and other state and federal laws. Its receipt or possession does not convey any rights to reproduce, disclose its contents, or to manufacture, use or sell anything it may describe. Reproduction, disclosure or use without specific written authorization of Pulse is strictly forbidden.

**Description:** LTE Primary + GNSS FPC Antenna

**Series:** Gemini

**PART NUMBER:** W3906B0100

**CHARTS**

**Peak Gain(dBi)**

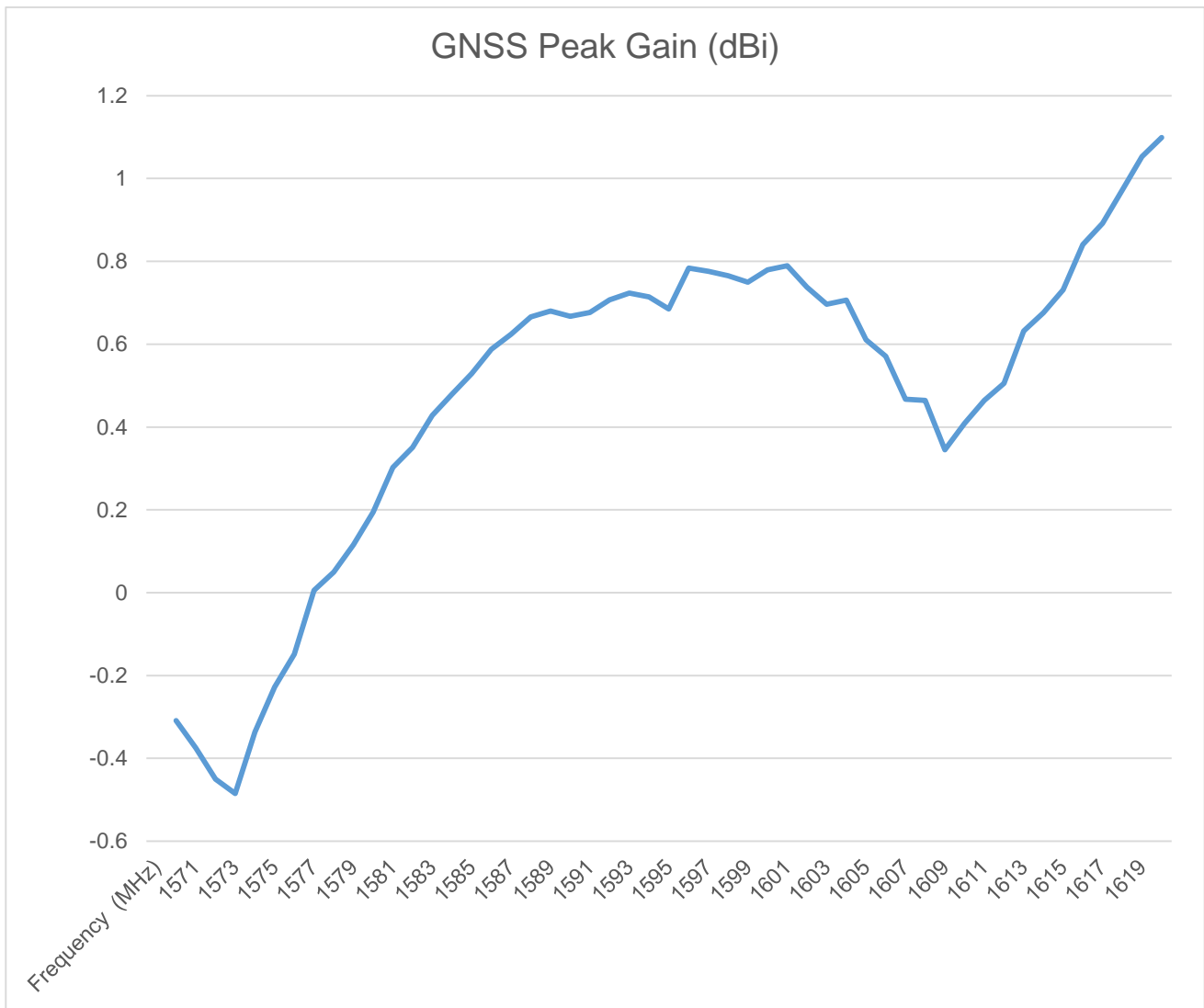

Issue: 2029

In the effort to improve our products, we reserve the right to make changes judged to be necessary.

CONFIDENTIAL AND PROPRIETARY INFORMATION

This document contains confidential and proprietary information of Pulse Electronics, Inc. (Pulse) and is protected by copyright, trade secret and other state and federal laws. Its receipt or possession does not convey any rights to reproduce, disclose its contents, or to manufacture, use or sell anything it may describe. Reproduction, disclosure or use without specific written authorization of Pulse is strictly forbidden.

**Description:** LTE Primary + GNSS FPC Antenna

**Series:** Gemini

**PART NUMBER:** W3906B0100

**CHARTS**

LTE radiation pattern  
698-960MHz  
(800MHz)

**Elevation Plane**

**Horizontal Plane**

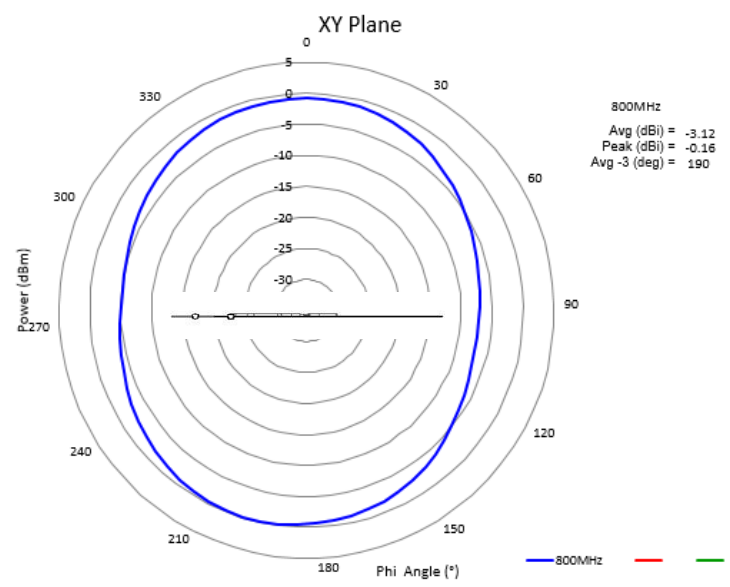
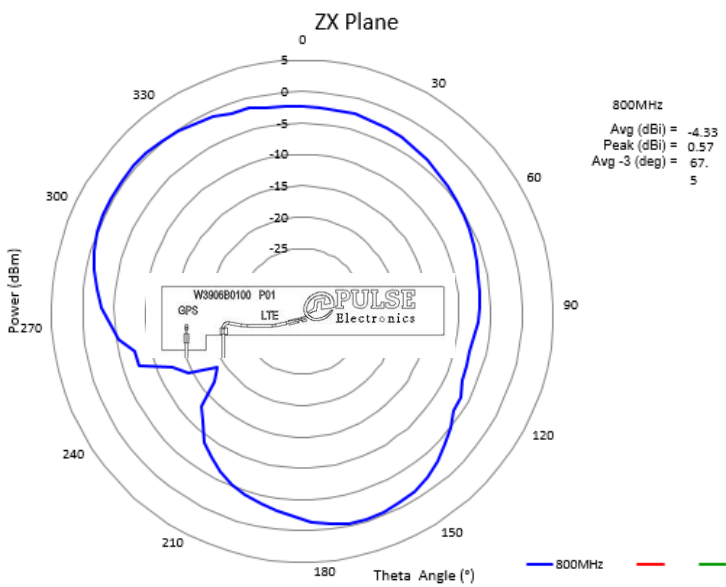

Issue: 2029

In the effort to improve our products, we reserve the right to make changes judged to be necessary.

CONFIDENTIAL AND PROPRIETARY INFORMATION

This document contains confidential and proprietary information of Pulse Electronics, Inc. (Pulse) and is protected by copyright, trade secret and other state and federal laws. Its receipt or possession does not convey any rights to reproduce, disclose its contents, or to manufacture, use or sell anything it may describe. Reproduction, disclosure or use without specific written authorization of Pulse is strictly forbidden.

Description: LTE Primary + GNSS FPC Antenna

Series: Gemini

PART NUMBER: W3906B0100

CHARTS

LTE radiation pattern  
1427.9-1510.9MHz  
(1450MHz)

Elevation Plane

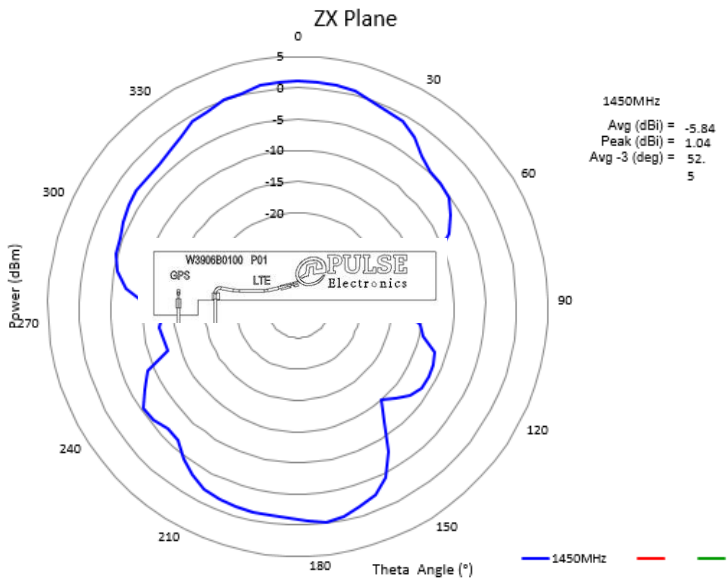

Horizontal Plane

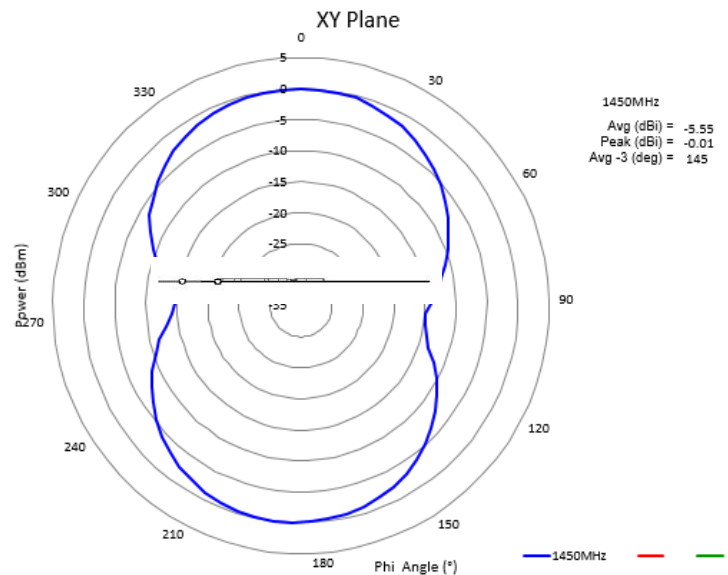

Issue: 2029

In the effort to improve our products, we reserve the right to make changes judged to be necessary.

CONFIDENTIAL AND PROPRIETARY INFORMATION

This document contains confidential and proprietary information of Pulse Electronics, Inc. (Pulse) and is protected by copyright, trade secret and other state and federal laws. Its receipt or possession does not convey any rights to reproduce, disclose its contents, or to manufacture, use or sell anything it may describe. Reproduction, disclosure or use without specific written authorization of Pulse is strictly forbidden.

Description: LTE Primary + GNSS FPC Antenna

Series: Gemini

PART NUMBER: W3906B0100

CHARTS

LTE radiation pattern  
1559-1610MHz  
(1570MHz)

Elevation Plane

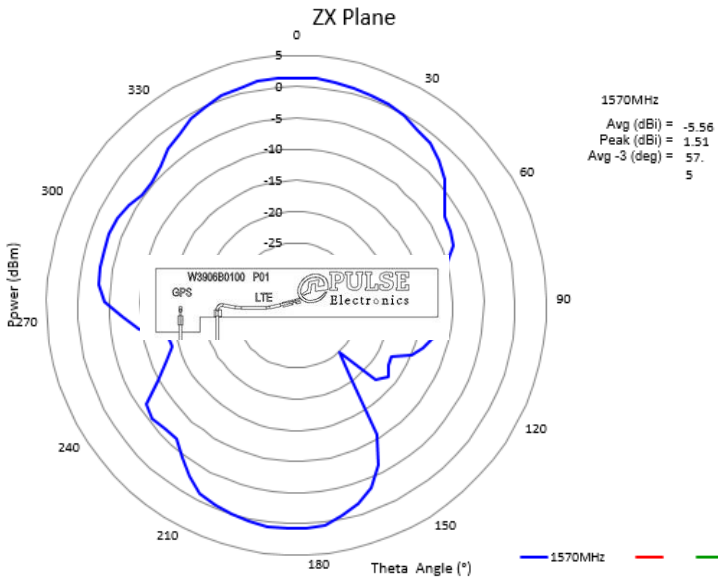

Horizontal Plane

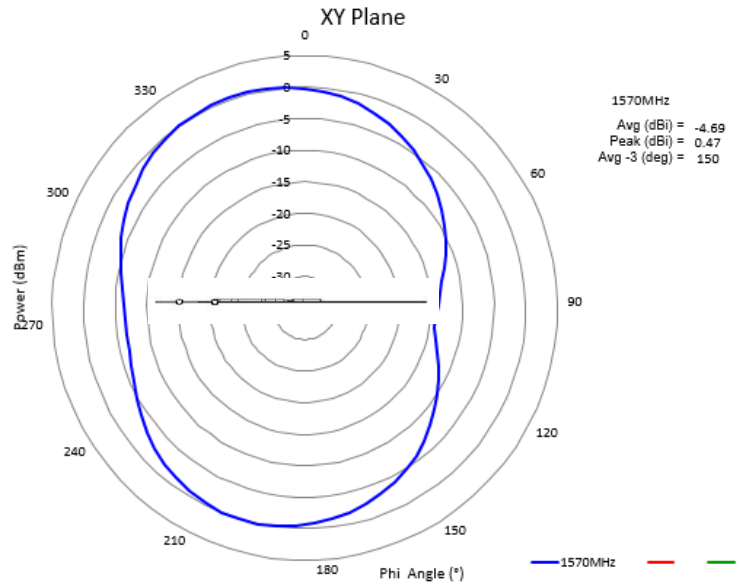

Issue: 2029

In the effort to improve our products, we reserve the right to make changes judged to be necessary.

CONFIDENTIAL AND PROPRIETARY INFORMATION

This document contains confidential and proprietary information of Pulse Electronics, Inc. (Pulse) and is protected by copyright, trade secret and other state and federal laws. Its receipt or possession does not convey any rights to reproduce, disclose its contents, or to manufacture, use or sell anything it may describe. Reproduction, disclosure or use without specific written authorization of Pulse is strictly forbidden.

**Description:** LTE Primary + GNSS FPC Antenna

**Series:** Gemini

**PART NUMBER:** W3906B0100

**CHARTS**

LTE radiation pattern  
1695-2200MHz  
(1930MHz)

**Elevation Plane**

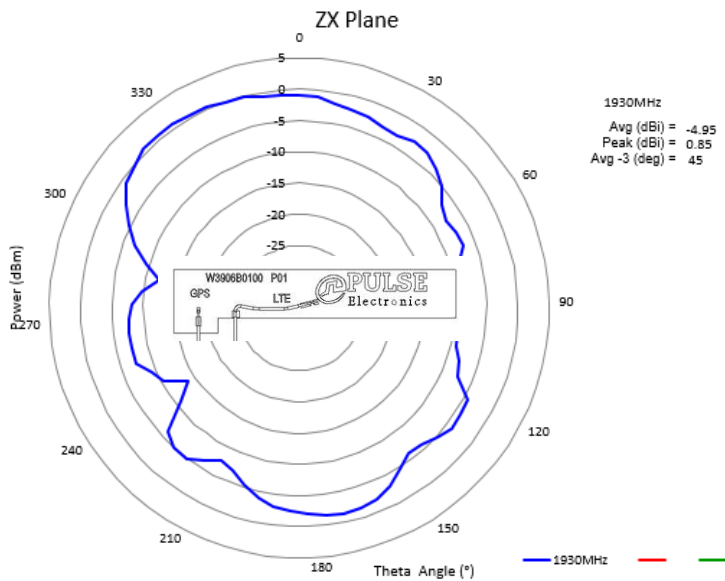

**Horizontal Plane**

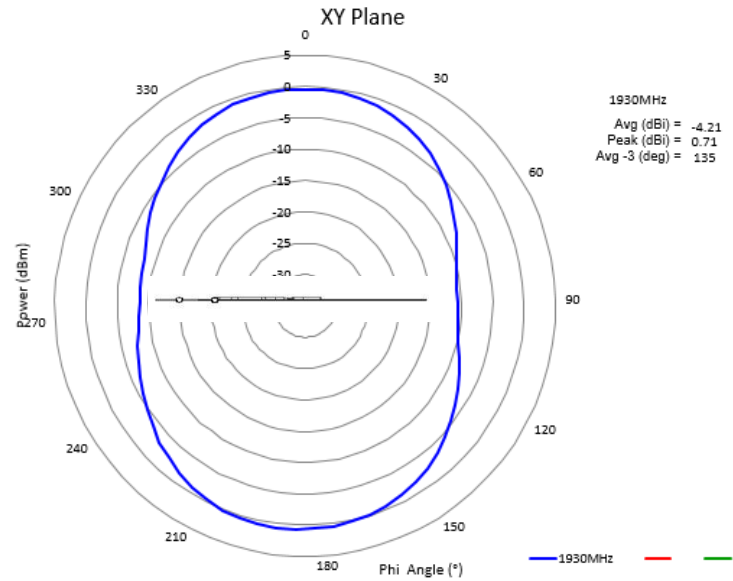

Issue: 2029

In the effort to improve our products, we reserve the right to make changes judged to be necessary.

CONFIDENTIAL AND PROPRIETARY INFORMATION

This document contains confidential and proprietary information of Pulse Electronics, Inc. (Pulse) and is protected by copyright, trade secret and other state and federal laws. Its receipt or possession does not convey any rights to reproduce, disclose its contents, or to manufacture, use or sell anything it may describe. Reproduction, disclosure or use without specific written authorization of Pulse is strictly forbidden.



Description: LTE Primary + GNSS FPC Antenna

Series: Gemini

PART NUMBER: W3906B0100

CHARTS

LTE radiation pattern  
2300-2700MHz  
(2390MHz)

Elevation Plane

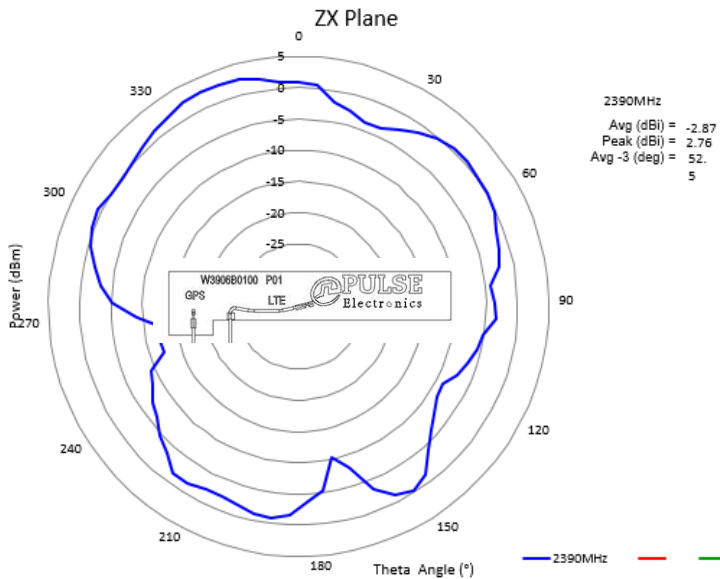

Horizontal Plane

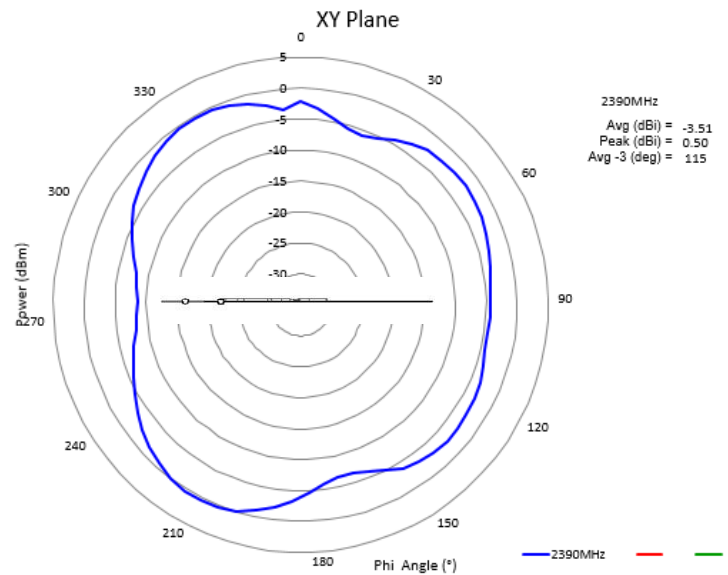

Issue: 2029

In the effort to improve our products, we reserve the right to make changes judged to be necessary.

CONFIDENTIAL AND PROPRIETARY INFORMATION

This document contains confidential and proprietary information of Pulse Electronics, Inc. (Pulse) and is protected by copyright, trade secret and other state and federal laws. Its receipt or possession does not convey any rights to reproduce, disclose its contents, or to manufacture, use or sell anything it may describe. Reproduction, disclosure or use without specific written authorization of Pulse is strictly forbidden.

**Description:** LTE Primary + GNSS FPC Antenna

**Series:** Gemini

**PART NUMBER:** W3906B0100

**CHARTS**

LTE radiation pattern  
3400-3600MHz  
(3400MHz)

**Elevation Plane**

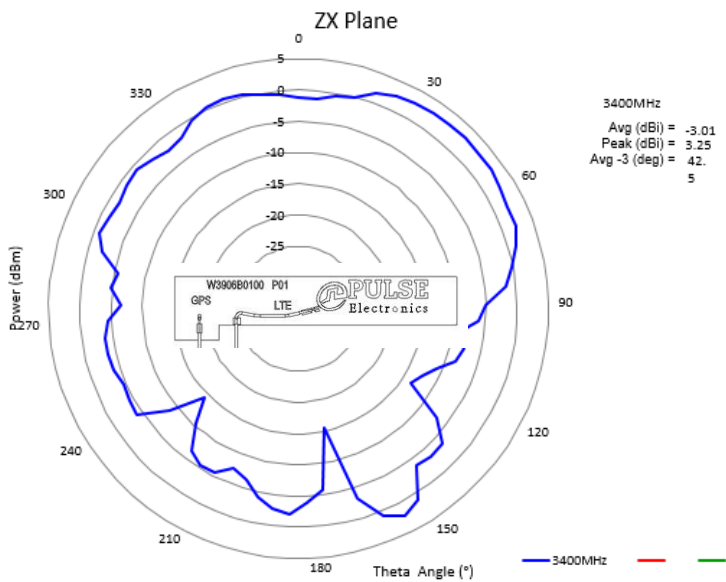

**Horizontal Plane**

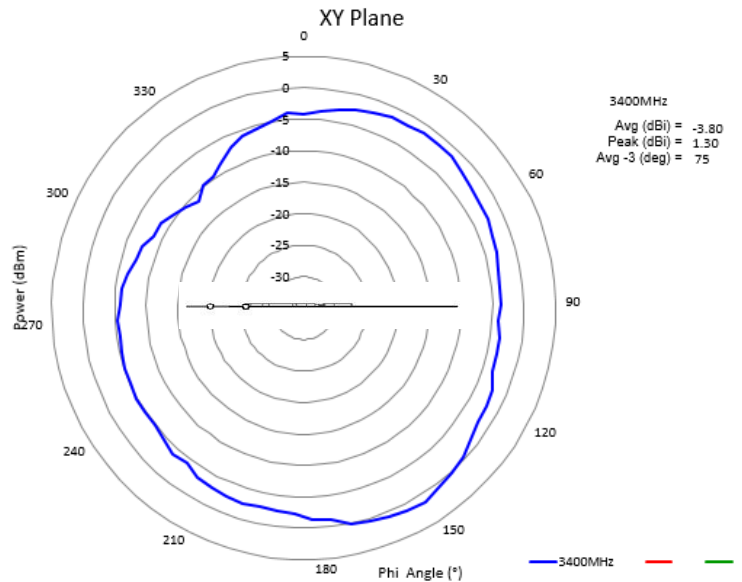

Issue: 2029

In the effort to improve our products, we reserve the right to make changes judged to be necessary.

CONFIDENTIAL AND PROPRIETARY INFORMATION

This document contains confidential and proprietary information of Pulse Electronics, Inc. (Pulse) and is protected by copyright, trade secret and other state and federal laws. Its receipt or possession does not convey any rights to reproduce, disclose its contents, or to manufacture, use or sell anything it may describe. Reproduction, disclosure or use without specific written authorization of Pulse is strictly forbidden.

**Description:** LTE Primary + GNSS FPC Antenna

**Series:** Gemini

**PART NUMBER:** W3906B0100

**CHARTS**

GNSS radiation pattern  
1570-1610MHz  
(1575MHz)

**Elevation Plane**

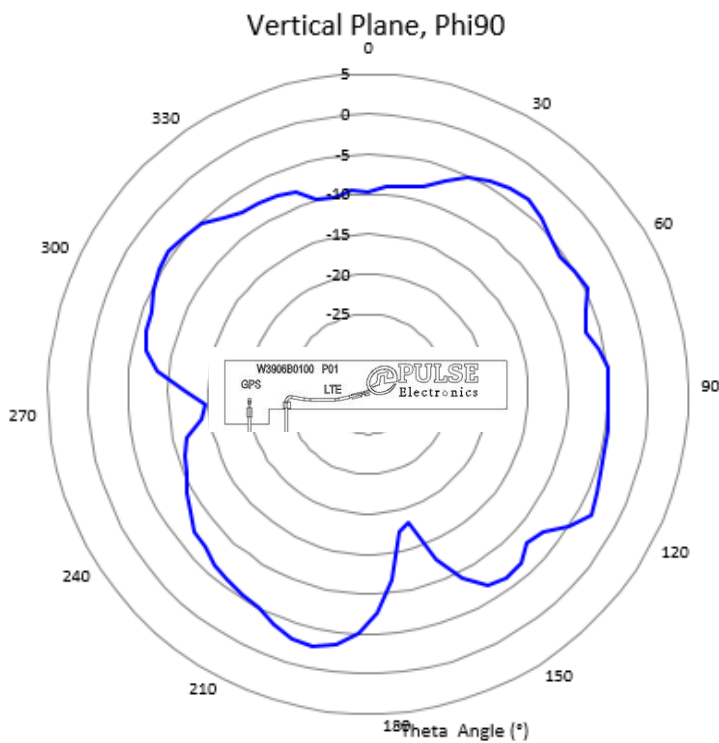

**Horizontal Plane**

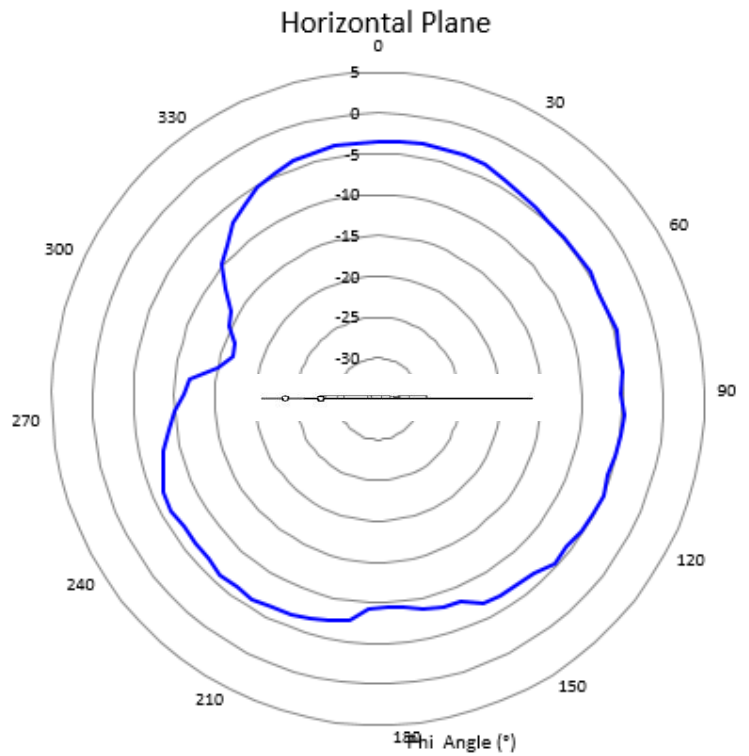

**Description:** LTE Primary + GNSS FPC Antenna

**Series:** Gemini

**PART NUMBER:** W3906B0100

## PACKAGING

5pcs antenna per PE bag

400pcs PE bags per form bag

2pcs form bag per package box

Total 4000pcs per package box

Package box: 460mm\*235mm\*140mm

## X-ON Electronics

Largest Supplier of Electrical and Electronic Components

*Click to view similar products for [Pulse manufacturer](#):*

Other Similar products are found below :

[ICEFIN806DMN](#) [ICEFIN698/869DMN](#) [PH9085.011NL](#) [PE-0603CD060KTT](#) [H1086NLT](#) [P0182T](#) [PA1494.442NL](#) [PE-0805CD030KTT](#) [PE-53363NLT](#) [23Z106SM-T](#) [HX5400NL](#) [JXD0-4005NL](#) [ST6200QNL](#) [T3001NL](#) [HX2019](#) [PE-67540NL](#) [PE-65968NL](#) [PE-65535NL](#) [T1142NLT](#) [H7019FNL](#) [P0841NL](#) [P0438T](#) [P0584](#) [P0752.474T](#) [P1167.154T](#) [STQN1553-45](#) [JY0-0016NL](#) [JG0-0098NL](#) [JG0-0025NL](#) [J20-0014NL](#) [W1911](#) [HX6101NL](#) [JXD1-0025NL](#) [RO2408NMD](#) [P0469NL](#) [P0841SNLT](#) [PB2134NL](#) [ST2-12B42](#) [PE-0805CM331JTT](#) [PE-51509NL](#) [53119](#) [J3026G01DNL](#) [P0849SNL](#) [W3012-K](#) [HX5020NL](#) [HX5201NL](#) [PE-68210NL](#) [T1124NL](#) [H5004NL](#) [JX30-0005NL](#)