

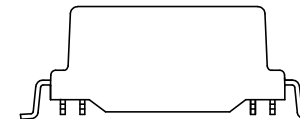

NOTES:

1. ROHS COMPLIANT
2. HEADER: DAP (DIALLYL PHTHALATE) WITH FLAMMABILITY RATING UL 94V-0 OR BETTER.
3. STORAGE TEMPERATURE: -50°C TO +125°C
4. COMPLIANCE TO J-STD:
  - A. J-STD-002: SOLDERABILITY AT 245°C REFLOW PROFILE
  - B. J-STD-020: LEVEL 1, NO MOISTURE SENSITIVE
  - C. J-STD-075: R7, 245°C MAXIMUM THROUGH REFLOW SOLDER
5. TO ORDER TAPE & REEL PACKAGING ADD A "T" SUFFIX TO THE PART NUMBER(i.e HM7142NL BECOMES HM7142NLT).

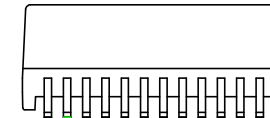
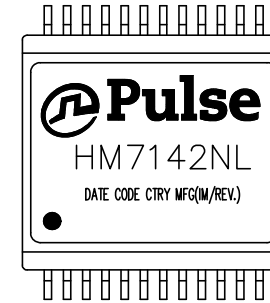

FINAL OUTLINE

© Copyright, 2018. Pulse Electronics Corp. All rights reserved. Pulse confidential & proprietary. (08/09/18)

PRODUCT DESCRIPTION	TLA DRAWING	PS DRAWING	SHEET	PART NO.	DATASHEET REV.
MDL,SIN,10G,1: 1,GEN2,SM,TU	HM7142NL-P4	PS-2517.001-B	1 OF 3	HM7142NL	C

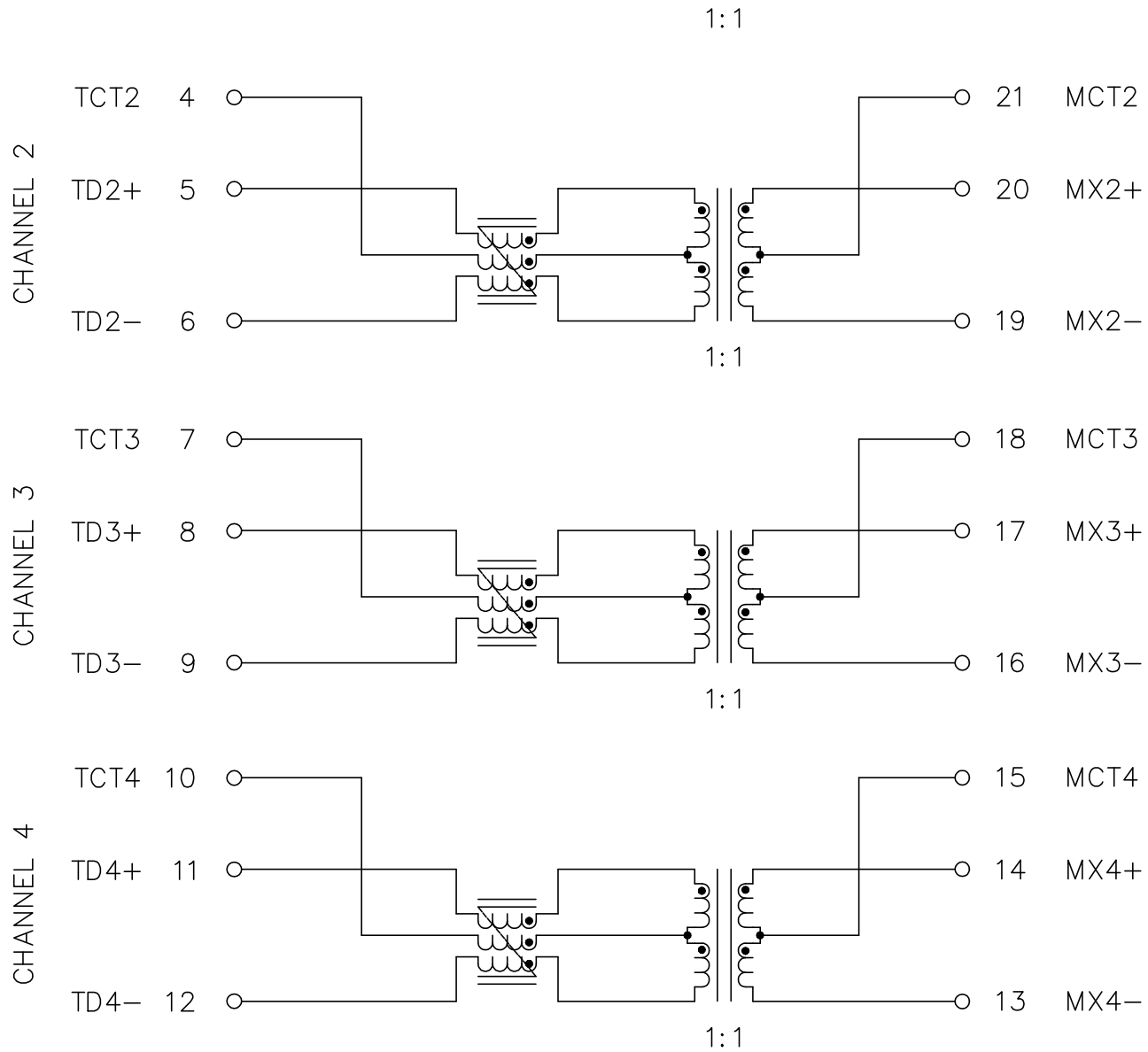

SCHMATIC

	OPERATING TEMPERATURE	
	URNS RATIO	
	POLARITY	
	INSERTION LOSS (SDD21)	100 KHz -3.0 dB M
▽	RETURN LOSS (Z OUT = 100 OHM ± 1%)	1 MHz -21
▽	INDUCTANCE (OCL)	15
	CROSSTALK, ADJACENT CHANNELS (SDD21 - ADJ.)	
	COMMON MODE REJECTION RATIO (SCC21)	1 MHz-100 -35 dB
	COMM. TO DIFF. REJECTION RATIO (SDC12)	
▽	INPUT - OUTPUT ISOLATION	

NOTE: 1. f IS FREQUENCY IN MHZ.

2. "▽" IS SPECIAL CHARACTERISTI

© Copyright, 2018. Pulse Electronics Corp. All rights reserved. Pulse confidential & proprietary. (08/09/18)

PRODUCT DESCRIPTION	TLA DRAWING	PS DRAWING	SHEET
MDL,SIN,10G,1:1,GEN2,SM,TU	HM7142NL-P4	PS-2517.001-B	2 OF 3

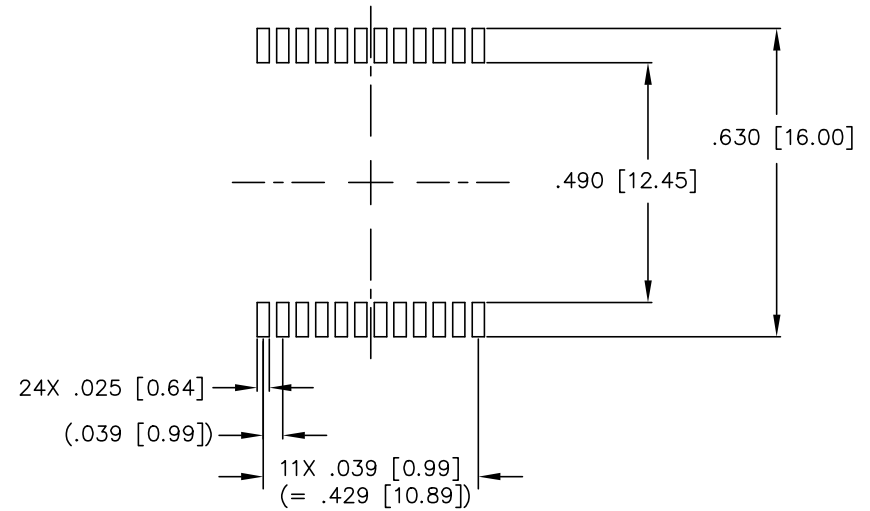
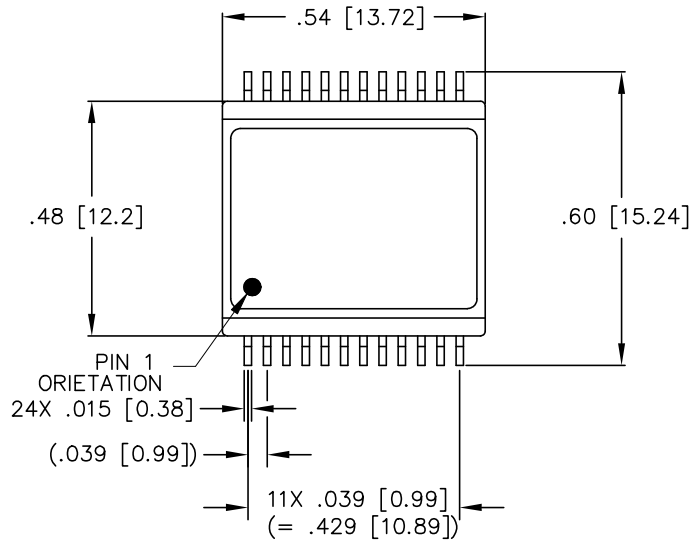

SUGGESTED LAND PATTERN

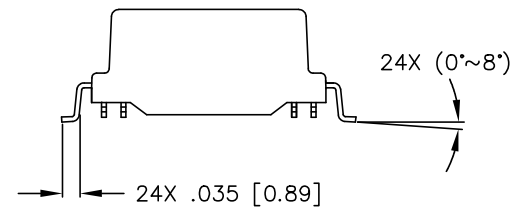
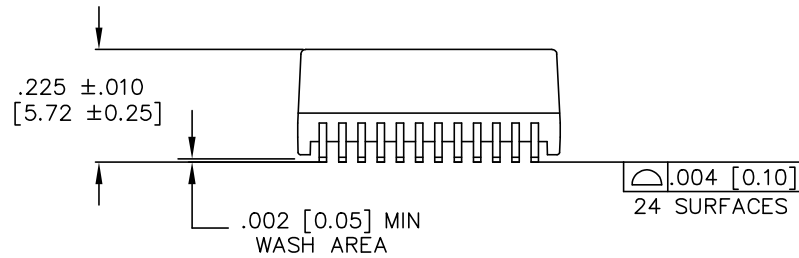

DIMENSIONS ARE IN INCHES [MILLIMETERS] WITH THE FOLLOWING TOLERANCES: [MILLIMETERS] ARE FOR REFERENCE ONLY.  
.XX= ±.01 [±0.25]  
.XXX= ±.005 [±0.13]

© Copyright, 2018. Pulse Electronics Corp. All rights reserved. Pulse confidential & proprietary. (08/09/18)

PRODUCT DESCRIPTION	TLA DRAWING	PS DRAWING	SHEET	PART NO.	DATASHEET REV.
MDL,SIN,10G,1: 1,GEN2,SM,TU	HM7142NL-P4	PS-2517.001-B	3 OF 3	HM7142NL	C

## X-ON Electronics

Largest Supplier of Electrical and Electronic Components

*Click to view similar products for [Audio Transformers / Signal Transformers](#) category:*

*Click to view products by [Pulse Electronics](#) manufacturer:*

Other Similar products are found below :

[CX2041NLT](#) [MGPWT-00449-P](#) [PE-64961](#) [H1302FNLT](#) [H5008FNL](#) [H5012FNL](#) [H5020FNLT](#) [H5077NLT](#) [H5084FNLT](#)  
[B78476A9558A003](#) [1812WBT2-4](#) [1879479-1](#) [HX2260FNL](#) [HX5014FNL](#) [EX2024FNL](#) [FL1066](#) [T1137NLT](#) [T3012NL](#) [PE-65812FNL](#) [PE-65848FNLT](#) [H1174FNL](#) [H1302FNL](#) [H5015FNL](#) [H5019EFNL](#) [H5062FNLT](#) [CX2047LNL](#) [MGPWT-00059-P](#) [MGPWT-00266-P](#) [MGPWT-00278-P](#) [MGPWT-00431-P](#) [TTC-100](#) [TTC-143-H](#) [TTC-5032-1](#) [BX1194WNLT](#) [HX1234NLT](#) [HX5008FNLT](#) [HX5019FNL](#) [HX5084NL](#) [3-1879385-5](#) [TX1263NLT](#) [4-1879391-0](#) [T1142NL](#) [HX6101FNL](#) [HX5084FNL](#) [HX1148NL](#) [HX5020FNLT](#) [HX5014FNLT](#) [T1124NL](#)  
[1879732-1](#) [2-1879391-5](#)