

1.575 GHz GPS Ceramic Chip Antenna

On Ground type, ie. solid ground plane under antenna, top surface ground removal 10.80 x 6.25 mm.

Pulse Part Number: W3009

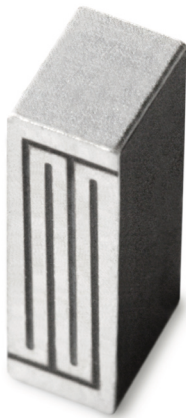

Features

- Omnidirectional radiation
- Low profile
- Compact size W x L x H (10 x 3.2 x 4 mm)
- Low weight (600 mg)
- Lead free materials
- Fully SMD compatible
- Lead free soldering compatible
- Tape and reel packing
- RoHS Compliant Product

Applications

- GPS L1 band
- 1.575 GHz

Electrical specifications @ +25 °C

Note: Electrical characteristics depend on test board (GP) size and antenna positioning on GP.

GPS

Typical performance (test board size 80 x 37 mm, PWB top surface ground removal area 10.80 x 6.25 mm)

Frequency Range [MHz]	RHCP Gain [dBic]	Linear Max Gain [dBi]	Efficiency [%] / [dB]	Return loss min. [dB]	Impedance [Ω]	Operating Temperature [°C]
1575.42 +/-10	0.7 (Peak) 0.3 (Band edges)	3 (Peak) 2.5 (Band edges)	80 / -1 (Peak) 75 / -1.25 (Band edges)	-10	50	-40 to +85

Pulse Finland Oy

Takatie 6
90440 Kempele, Finland
Tel: +358 207 935 500
Fax: +358 207 935 501

www.pulseeng.com/antennas



1.575 GHz GPS Ceramic Chip Antenna

On Ground type, ie. solid ground plane under antenna, top surface ground removal 10.80 x 6.25 mm.

Pulse Part Number: W3009

Terminal Configuration

Layout

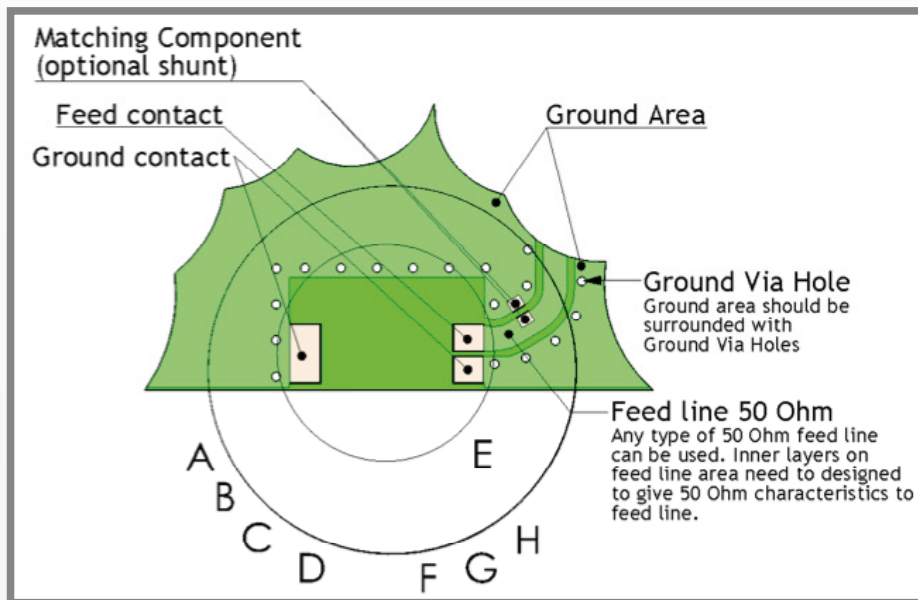

Pad dimensions in top copper

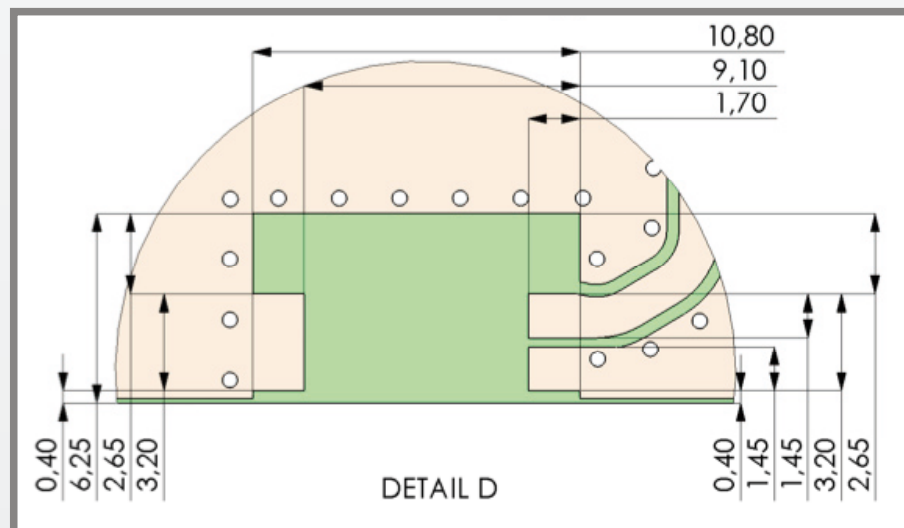

1.575 GHz GPS Ceramic Chip Antenna

On Ground type, ie. solid ground plane under antenna, top surface ground removal 10.80 x 6.25 mm.

Pulse Part Number: W3009

Terminal Configuration

Antenna

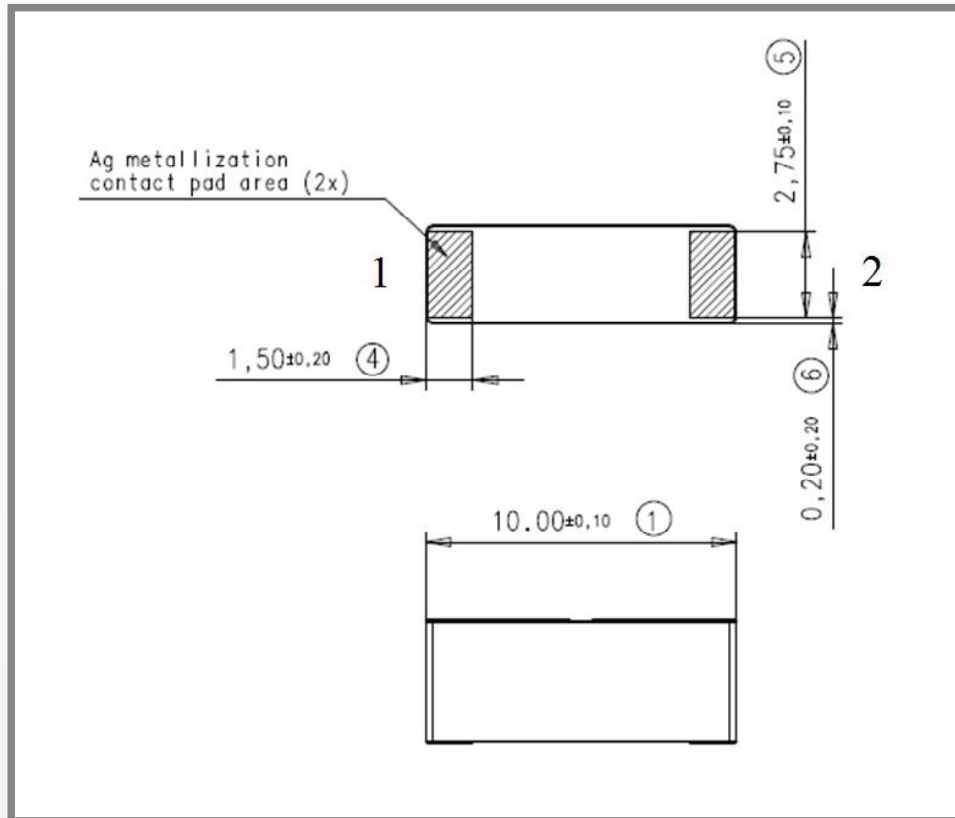

No.	Terminal Name	Terminal Dimensions
1	Feed / GND	1.50 x 2.75 mm
2	Feed / GND	1.50 x 2.75 mm

Antenna is symmetrical. Either of terminals 1 or 2 can be Feed / GND

Pulse Finland Oy

Takatie 6

90440 Kempele, Finland

Tel: +358 207 935 500

Fax: +358 207 935 501

www.pulseeng.com/antennas



1.575 GHz GPS Ceramic Chip Antenna

On Ground type, ie. solid ground plane under antenna, top surface ground removal 10.80 x 6.25 mm.

Pulse Part Number: W3009

Typical Electrical Characteristics (T=25 °C)

Measured on the 80 x 37 mm test board with matching circuit (2.2 pF shunt matching capacitor on feed).

Typical Return Loss S11/ impedance, free space efficiency and gain

GPS Ceramic Chip Antenna

25 May 2007 07:22:17

CH1Markers

- 1. -12.032 dB 1.56500 GHz
- 2. -20.839 dB 1.575.420 MHz
- 3. -11.637 dB 1.58500 GHz

CH1 S11 LOG

5 dB/REF 0 dB

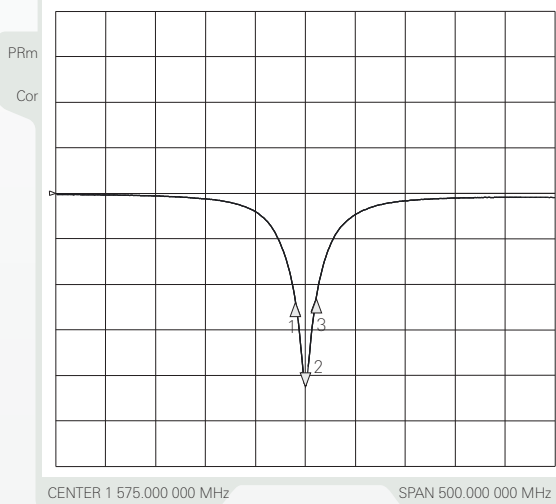

GPS Ceramic Chip Antenna

25 May 2007 07:23:38

- 1. 64.203 Ω 25.500 Ω 1.56500 GHz
- 2. 56.211 Ω -8.5977 Ω 11.750 pF
1.575.420 000 MHz
- 3. 33.688 Ω -17.396 Ω 1.58500 GHz

CH1 S11 1 U FS

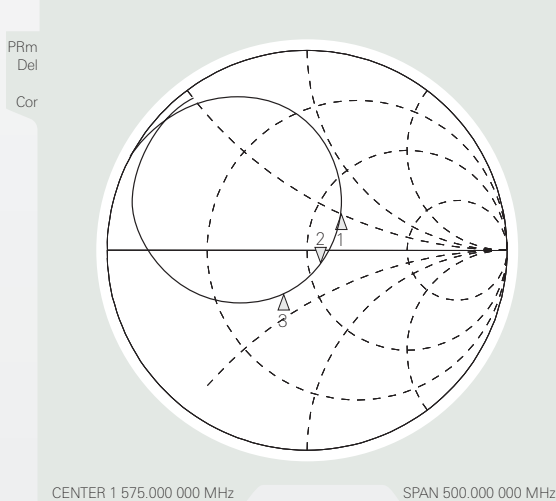

GPS OG 10 x 3.2 x 4 mm

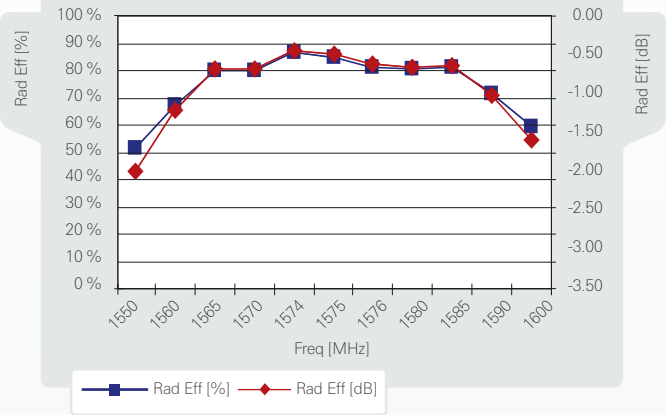

GPS OG 10 x 3.2 x 4 mm

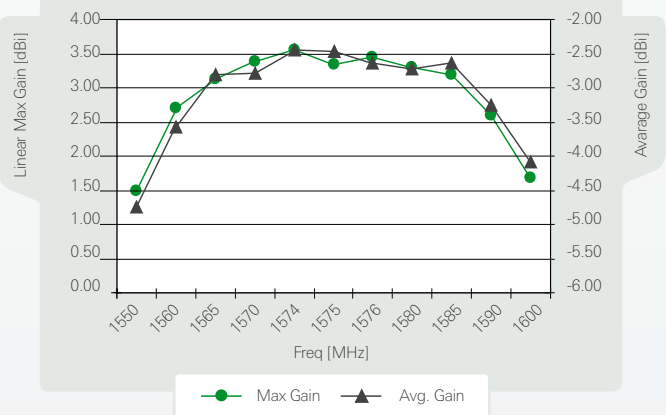

GPS OG 10 x 3.2 x 4 mm

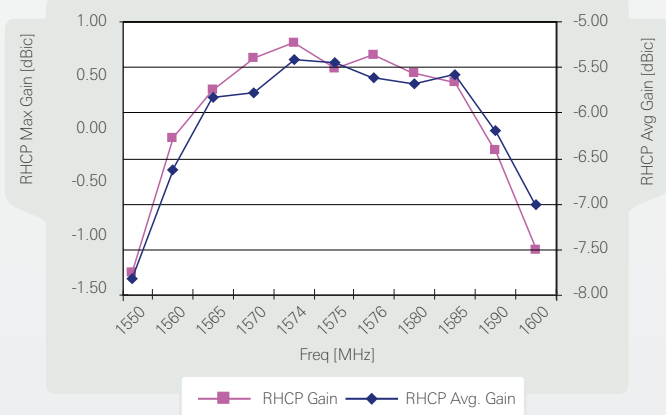

Pulse Finland Oy

Takatie 6
90440 Kempele, Finland
Tel: +358 207 935 500
Fax: +358 207 935 501
www.pulseeng.com/antennas



1.575 GHz GPS Ceramic Chip Antenna

On Ground type, ie. solid ground plane under antenna, top surface ground removal 10.80 x 6.25 mm.

Pulse Part Number: W3009

Typical Free Space Radiation Patterns

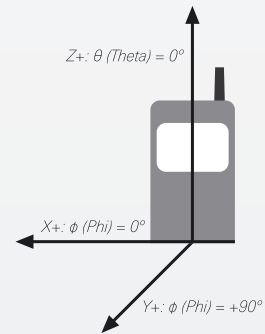
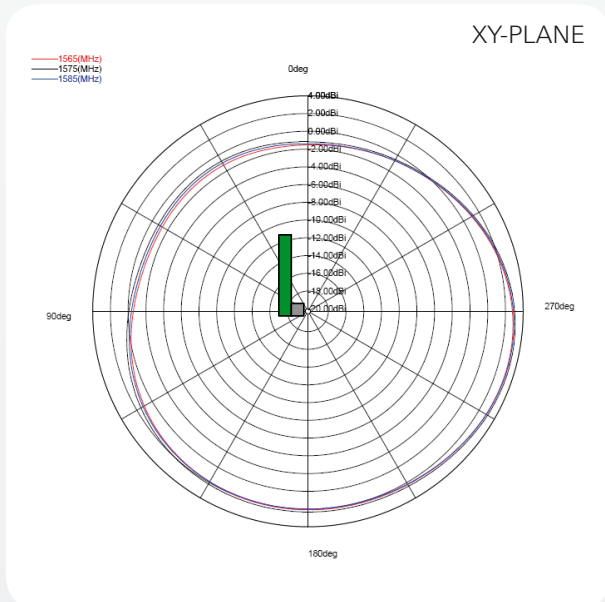
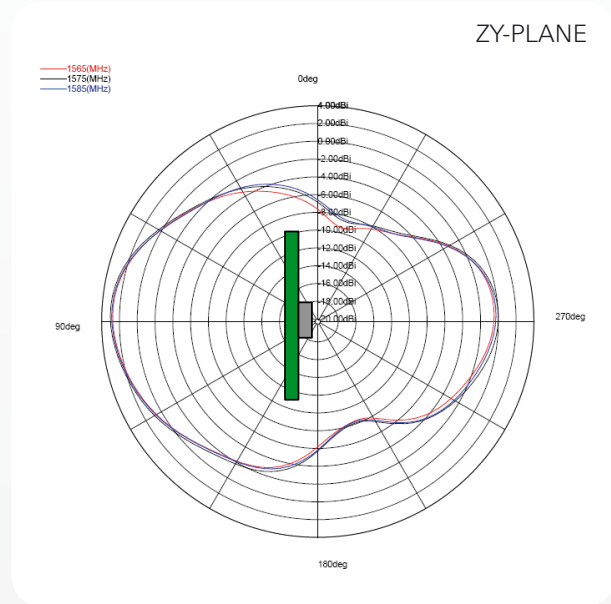
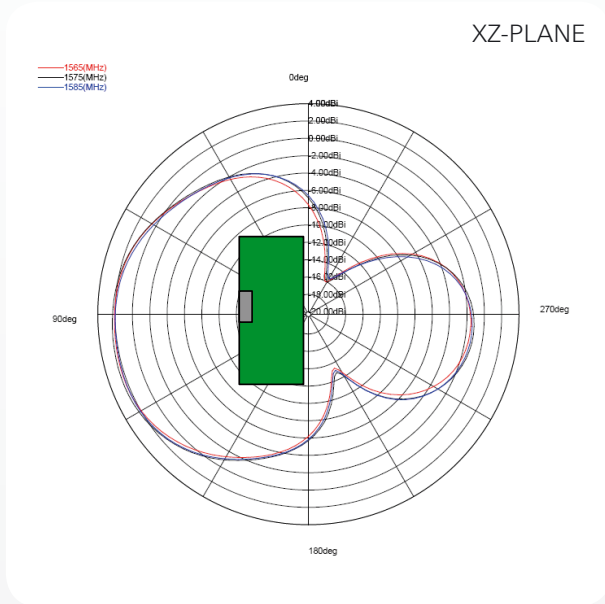

1.575 GHz GPS Ceramic Chip Antenna

On Ground type, ie. solid ground plane under antenna, top surface ground removal 10.80 x 6.25 mm.

Pulse Part Number: W3009

W3009 GPS Antenna Packing

Packing form

Carrier tape reel showing dimensions: $\varnothing 180\text{mm}$ and 500 PCS/REEL.

CARRIER TAPE H85-00158
width=24,00 depth=4.15
COVER TAPE H85-00159
width=21.20

LENGTH OF TAPE:

- Leader section: min 350 mm before component section
- Trailer section: min 40 mm after component section.

Empty part cavities at leader and trailer section of the tape must be sealed with top cover tape.

BOX H85-00128 (182x182x125)	1 pcs
- LABEL	1 pcs/BOX
REEL H85-00160 (D180, W28)	4 pcs
- REEL LABEL	1 pcs/REEL

MATERIAL			
HANDLINGS			
		RATIO	DRWN 160107 PeHa H
			DGNER
PRODUCT	H90-OY800-F01P01		CHKD
			APPRD
DENOMINATION	PACKING FORM		APPRD BY
			VERSION
			MOD/DATE/NAME

Pulse Finland Oy

Takatie 6

90440 Kempele, Finland

Tel: +358 207 935 500

Fax: +358 207 935 501

www.pulseeng.com/antennas



X-ON Electronics

Largest Supplier of Electrical and Electronic Components

Click to view similar products for [Antenna Development Tools](#) category:

Click to view products by [PulseLarsen](#) manufacturer:

Other Similar products are found below :

[0868AT43A0020-EB1SMA](#) [EVALBGSA141MN10TOBO1](#) [A10393-U1](#) [PCSD.06.A](#) [B5771-U1](#) [KIT-LTE-GNSS-01](#) [KIT-WIFI-ISM-01](#)
[A10472-U1](#) [REFLECTOR-EVB-1](#) [A10340-U1](#) [ACAG0201-2450-EVB](#) [ACAG0301-15752450-EVB](#) [ACAG0301-1575-EVB](#) [ACAG0301-24505500-EVB](#) [ACAG0301-5500-EVB](#) [ACAG0801-2450-EVB](#) [ACAG1204-433-EVB](#) [ACAG1204-868-EVB](#) [ACAG1204-915-EVB](#)
[ACAR0301-SW2-EVB](#) [ACAR3005-C2WB-EVB](#) [ACAR3005-S824-EVB](#) [ACAR3705-S698-EVB](#) [ACAR4008-S698-EVB](#) [A10137-D](#)
[A10194-U1](#) [A10204-U1](#) [A5645H-EVB-1](#) [A5645-U1](#) [A5887H-EVB-1](#) [A6111-U1](#) [M20057-EVB-1](#) [SR42W001-U1](#) [SR42W009-U1](#)
[SR4G008-U1](#) [SR4G013-U1](#) [SR4G053-EVB-1](#) [SR4L049-EVB-1](#) [SRC5G027-U1](#) [SRCW004-U1](#) [1001312-01](#) [M310220-01](#) [M620720-01](#)
[M830120-01](#) [M830520-01](#) [EB_NN01-105A](#) [EB_NN02-201-5G](#) [CCKLTE450-NA](#) [AEK-GNCP-TH258L15](#) [MPA-104- KIT](#)