

Description: GNSS-DUAL WIFI-DSRC ANT

Series: CERAMIC CHIP

PART NUMBER: W3095

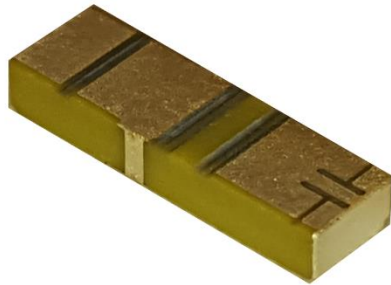

Features:

- 3 in 1 solution on a ceramic chip with two separate feeds.
- Need smaller antenna space on PCB to integrate GPS/GLONASS, Dual WiFi and DSRC bands
- Compact Size (L x W x H) 10 x 3.2 x 1.5mm.
- Fully SMD compatible

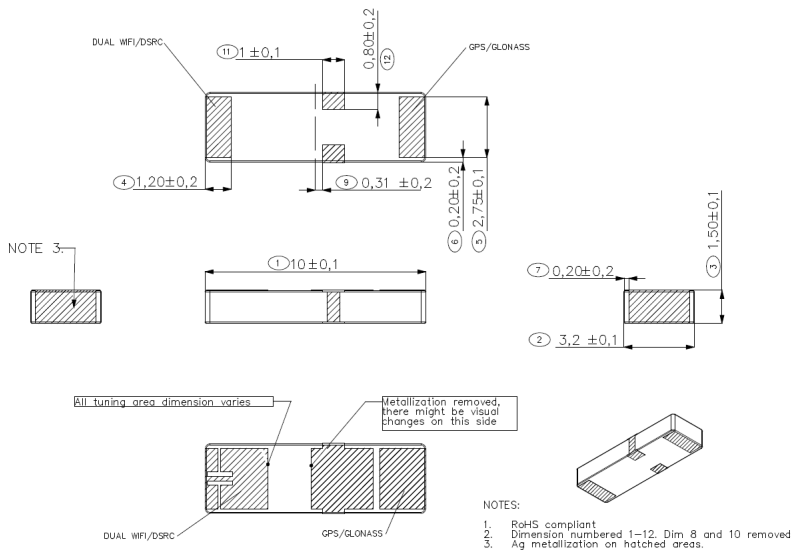

Applications:

- GPS / GLONASS (1575-1610MHz)
- IEEE 802.11 a/b/g/n compliant 2.4 and 5GHz. (2400-2485/ 4900-5850MHz)
- DSRC (5850-5925MHz)
- Mobile navigation device

All dimensions are in mm / inches

Issue: 1804

In the effort to improve our products, we reserve the right to make changes judged to be necessary.

CONFIDENTIAL AND PROPRIETARY INFORMATION

This document contains confidential and proprietary information of Pulse Electronics, Inc. (Pulse) and is protected by copyright, trade secret and other state and federal laws. Its receipt or possession does not convey any rights to reproduce, disclose its contents, or to manufacture, use or sell anything it may describe. Reproduction, disclosure or use without specific written authorization of Pulse is strictly forbidden.

For more information:

Pulse Worldwide Headquarters
15255 Innovation Drive #100
San Diego, CA 92128
USA
Tel: 1-858-674-8100

Pulse/Larsen Antennas
18110 SE 34th St Bldg 2 Suite 250
Vancouver, WA 98683
USA
Tel: 1-360-944-7551

Europe Headquarters
Pulse GmbH & Do, KG
Zeppelinstrasse 15
Herrenberg, Germany
Tel: 49 7032 7806 0

Pulse (Suzhou) Wireless Products Co, Inc.
99 Huo Ju Road(#29 Bldg,4th Phase
Suzhou New District
Jiangsu Province, Suzhou 215009 PR China
Tel: 86 512 6807 9998



Description: GNSS-DUAL WIFI-DSRC ANT**Series:** CERAMIC CHIP**PART NUMBER:** W3095**ELECTRICAL SPECIFICATIONS**

Frequency, Port 1	1.575-1.610 GHz
Frequency, Port 2	2.4-2.485/ 4.9-5.925 GHz
Normal Impedance	50 Ohm
VSWR, Port 1	<2.5:1
VSWR, Port 2	<2:1 at low band <2.8:1 at high band
Efficiency (Typ.), Port 1	60 %
Efficiency (Typ.), Port 2	80/ 50 %
Peak Gain, Port 1	1.5 dBi
Peak Gain, Port 2	2.5/ 3.5 dBi
Isolation (Min.) at 1.575-1.610 GHz	22 dB
Isolation (Min.) at 2.4-2.485 GHz	20 dB
Isolation (Min.) at 4.9-5.925 GHz	22 dB
Polarization	Linear
Interface	SMD Mount

Issue: 1804

In the effort to improve our products, we reserve the right to make changes judged to be necessary.

CONFIDENTIAL AND PROPRIETARY INFORMATION

This document contains confidential and proprietary information of Pulse Electronics, Inc. (Pulse) and is protected by copyright, trade secret and other state and federal laws. Its receipt or possession does not convey any rights to reproduce, disclose its contents, or to manufacture, use or sell anything it may describe. Reproduction, disclosure or use without specific written authorization of Pulse is strictly forbidden.

Description: GNSS-DUAL WIFI-DSRC ANT

Series: CERAMIC CHIP

PART NUMBER: W3095

MECHANICAL SPECIFICATIONS

Block material	Dielectric ceramic
Plating material	Ag
Weight	0.24 g
RoHS Compliant Product	
Tape and reel packing	
Lead free materials	
Lead free soldering compatible	

ENVIRONMENTAL SPECIFICATIONS

Operating temperature	-30 to +80° C
-----------------------	---------------

Description: GNSS-DUAL WIFI-DSRC ANT

Series: CERAMIC CHIP

PART NUMBER: W3095

MECHANICAL DRAWING

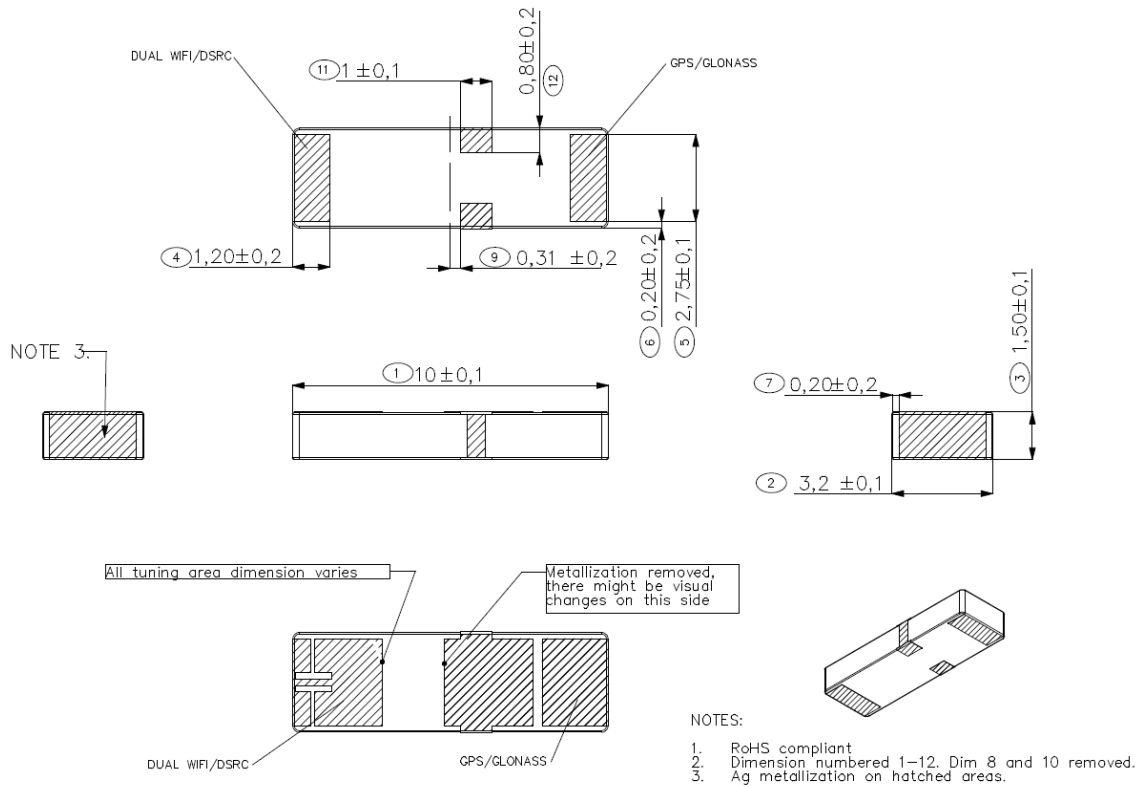

Dimensions: (mm)

Details of antenna pad dimension on the bottom in mm.

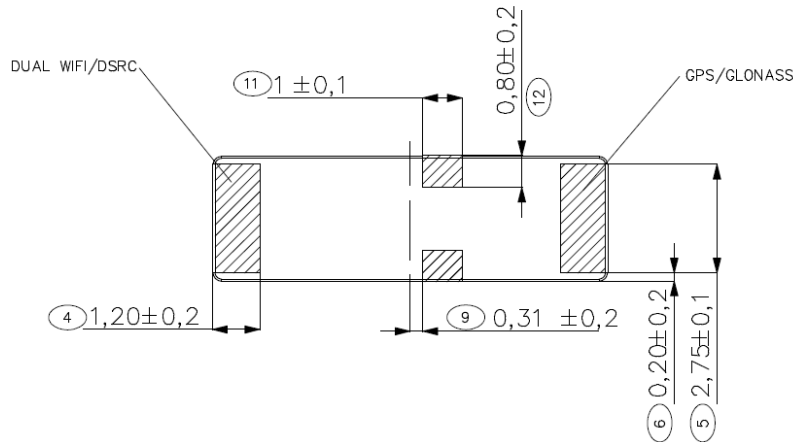

Issue: 1804

In the effort to improve our products, we reserve the right to make changes judged to be necessary.

CONFIDENTIAL AND PROPRIETARY INFORMATION

This document contains confidential and proprietary information of Pulse Electronics, Inc. (Pulse) and is protected by copyright, trade secret and other state and federal laws. Its receipt or possession does not convey any rights to reproduce, disclose its contents, or to manufacture, use or sell anything it may describe. Reproduction, disclosure or use without specific written authorization of Pulse is strictly forbidden.

Description: GNSS-DUAL WIFI-DSRC ANT

Series: CERAMIC CHIP

PART NUMBER: W3095

OTHER SPECIFICATIONS

PCB Layout Recommendation

Top Side

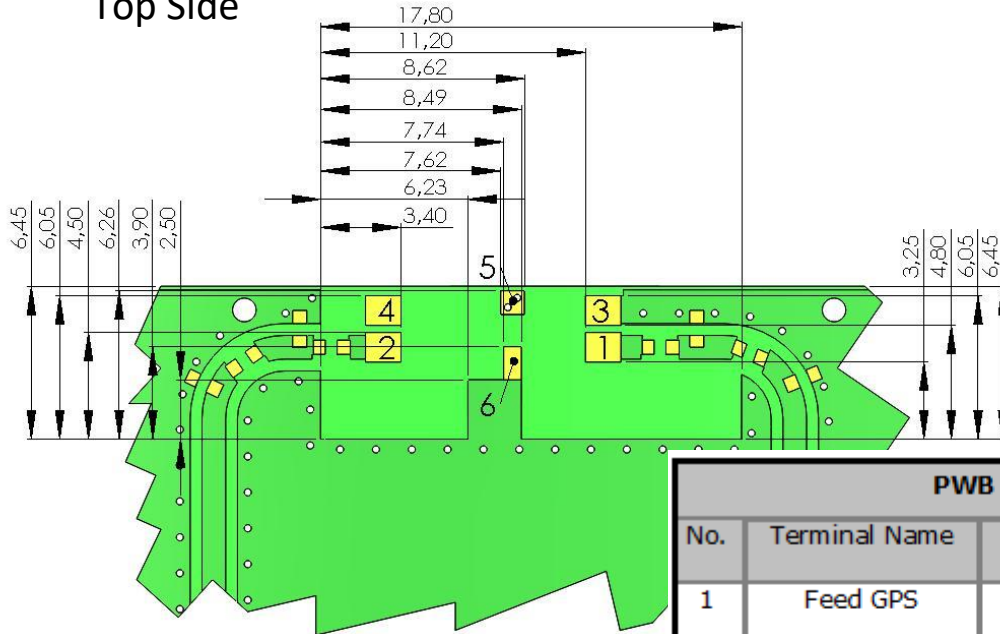

PWB features		
No.	Terminal Name	Terminal Dimensions
1	Feed GPS	1.25 x 1.50 mm
2	Feed 2,4-5,925GHZ	1.25 x 1.50 mm
3	GND	1.25 x 1.50 mm
4	Support pad	1.25 x 1.50 mm
5	GND	1.00 x 1.00 mm
6	GND	1.40x 0.75 mm

Bottom Side

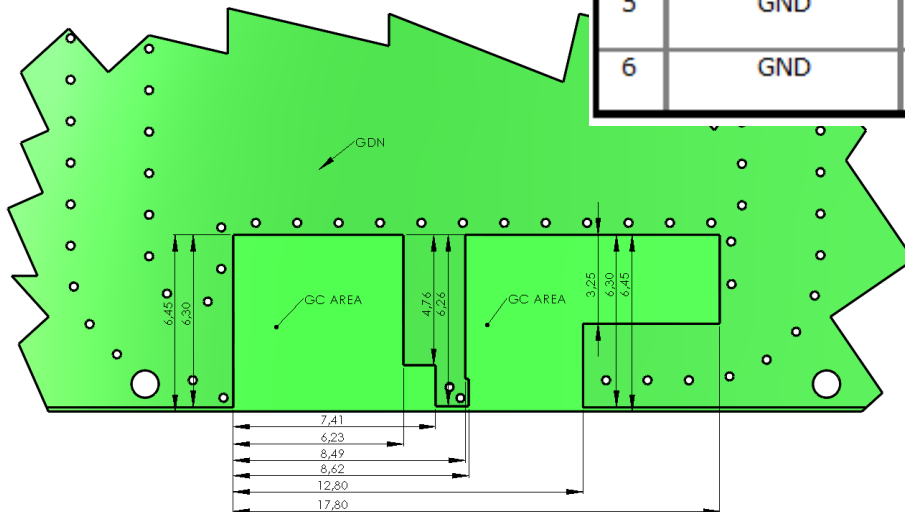

Issue: 1804

In the effort to improve our products, we reserve the right to make changes judged to be necessary.

CONFIDENTIAL AND PROPRIETARY INFORMATION

This document contains confidential and proprietary information of Pulse Electronics, Inc. (Pulse) and is protected by copyright, trade secret and other state and federal laws. Its receipt or possession does not convey any rights to reproduce, disclose its contents, or to manufacture, use or sell anything it may describe. Reproduction, disclosure or use without specific written authorization of Pulse is strictly forbidden.

Description: GNSS-DUAL WIFI-DSRC ANT

Series: CERAMIC CHIP

PART NUMBER: W3095

OTHER SPECIFICATIONS

Antenna Alignment on PCB Layout

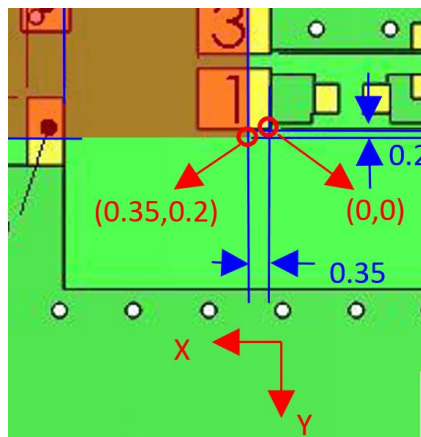
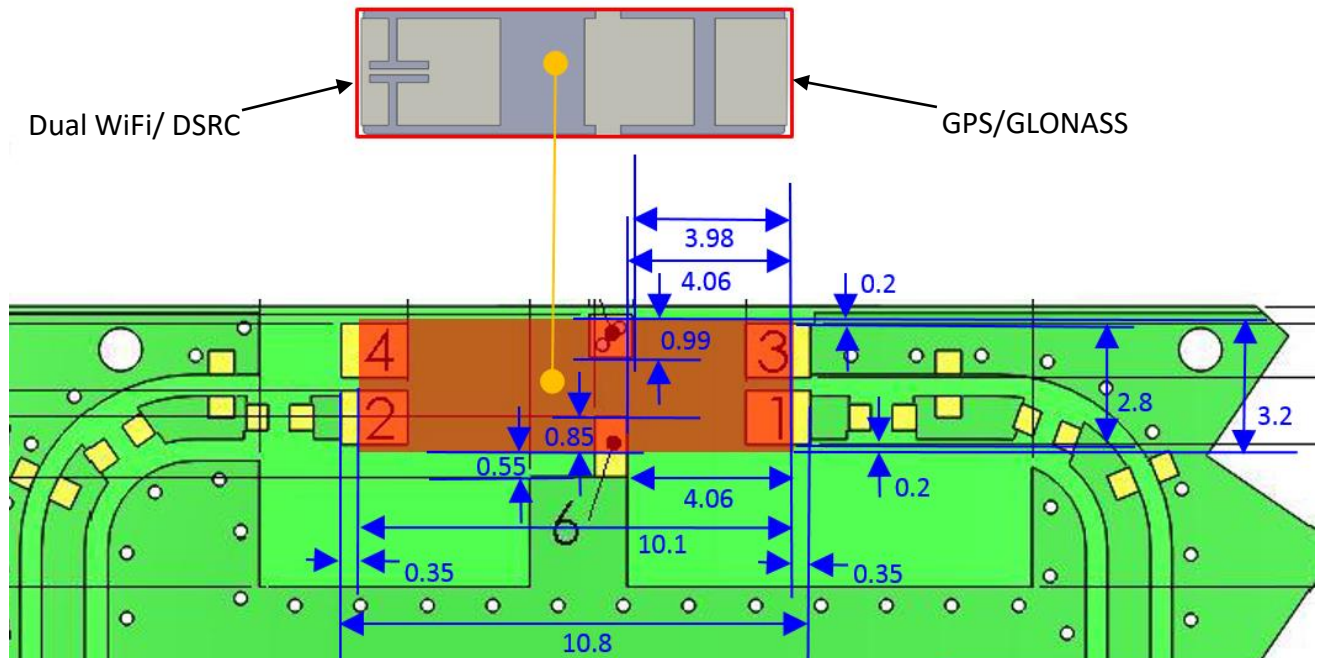

Issue: 1804

In the effort to improve our products, we reserve the right to make changes judged to be necessary.

CONFIDENTIAL AND PROPRIETARY INFORMATION

This document contains confidential and proprietary information of Pulse Electronics, Inc. (Pulse) and is protected by copyright, trade secret and other state and federal laws. Its receipt or possession does not convey any rights to reproduce, disclose its contents, or to manufacture, use or sell anything it may describe. Reproduction, disclosure or use without specific written authorization of Pulse is strictly forbidden.

Description: GNSS-DUAL WIFI-DSRC ANT

Series: CERAMIC CHIP

PART NUMBER: W3095

OTHER SPECIFICATIONS

Suggested Matching on PCB

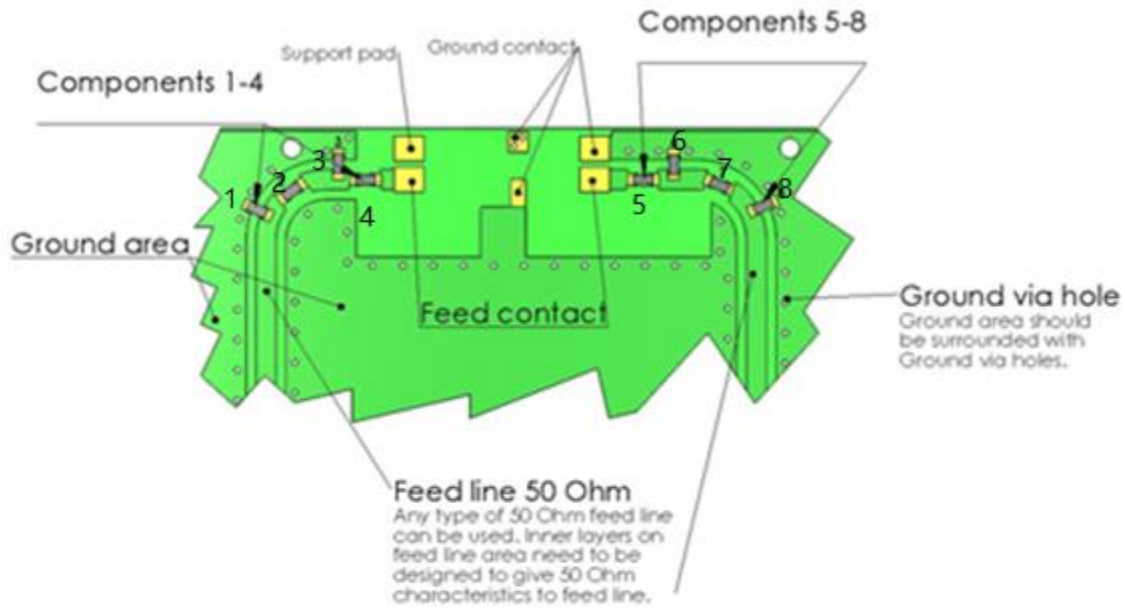

Antenna	Component NO.	Value
2.4-5.925GHz	1	Optional, not in use
2.4-5.925GHz	2	0 Ohm
2.4-5.925GHz	3	2.2nH
2.4-5.925GHz	4	1.2pF
GPS/Glonass	5	0 Ohm
GPS/Glonass	6	1.8pF
GPS/Glonass	7	0 Ohm
GPS/Glonass	8	Optional, not in use

Issue: 1804

In the effort to improve our products, we reserve the right to make changes judged to be necessary.

CONFIDENTIAL AND PROPRIETARY INFORMATION

This document contains confidential and proprietary information of Pulse Electronics, Inc. (Pulse) and is protected by copyright, trade secret and other state and federal laws. Its receipt or possession does not convey any rights to reproduce, disclose its contents, or to manufacture, use or sell anything it may describe. Reproduction, disclosure or use without specific written authorization of Pulse is strictly forbidden.

Description: GNSS-DUAL WIFI-DSRC ANT

Series: CERAMIC CHIP

PART NUMBER: W3095

CHARTS

Typical GPS/GLONASS antenna Return Loss

LOG

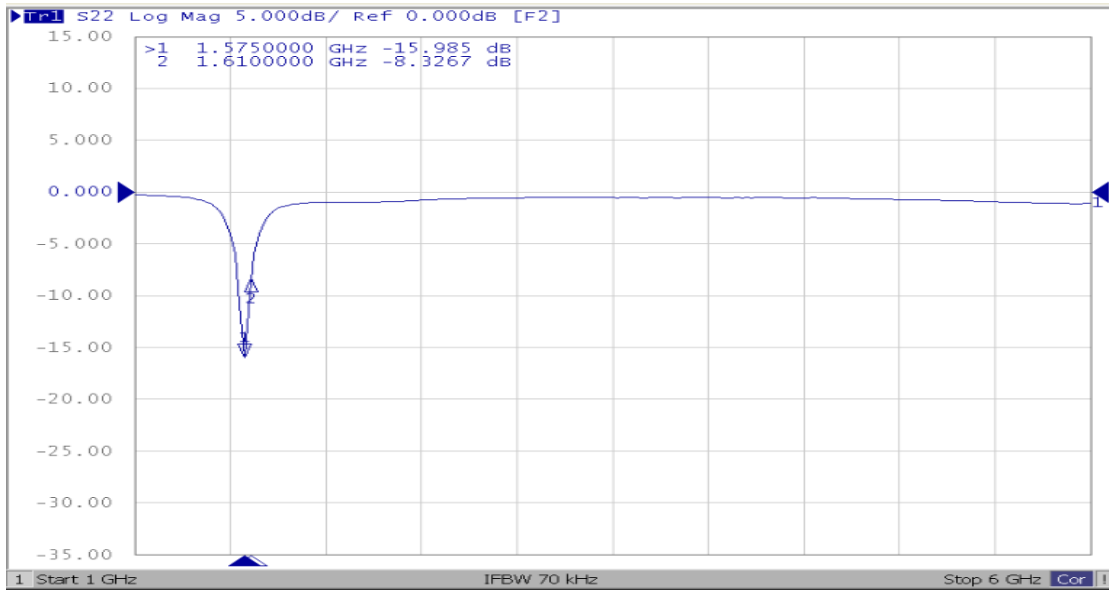

VSWR



Issue: 1804

In the effort to improve our products, we reserve the right to make changes judged to be necessary.

CONFIDENTIAL AND PROPRIETARY INFORMATION

This document contains confidential and proprietary information of Pulse Electronics, Inc. (Pulse) and is protected by copyright, trade secret and other state and federal laws. Its receipt or possession does not convey any rights to reproduce, disclose its contents, or to manufacture, use or sell anything it may describe. Reproduction, disclosure or use without specific written authorization of Pulse is strictly forbidden.

Description: GNSS-DUAL WIFI-DSRC ANT

Series: CERAMIC CHIP

PART NUMBER: W3095

CHARTS

Typical WIFI antenna Return Loss

LOG

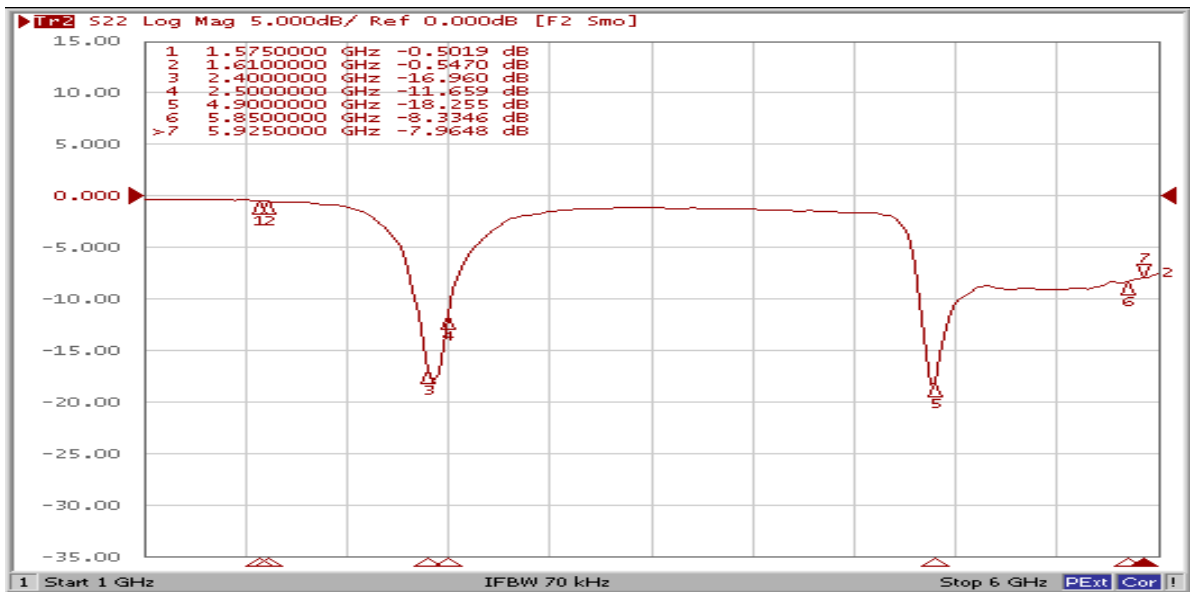

VSWR

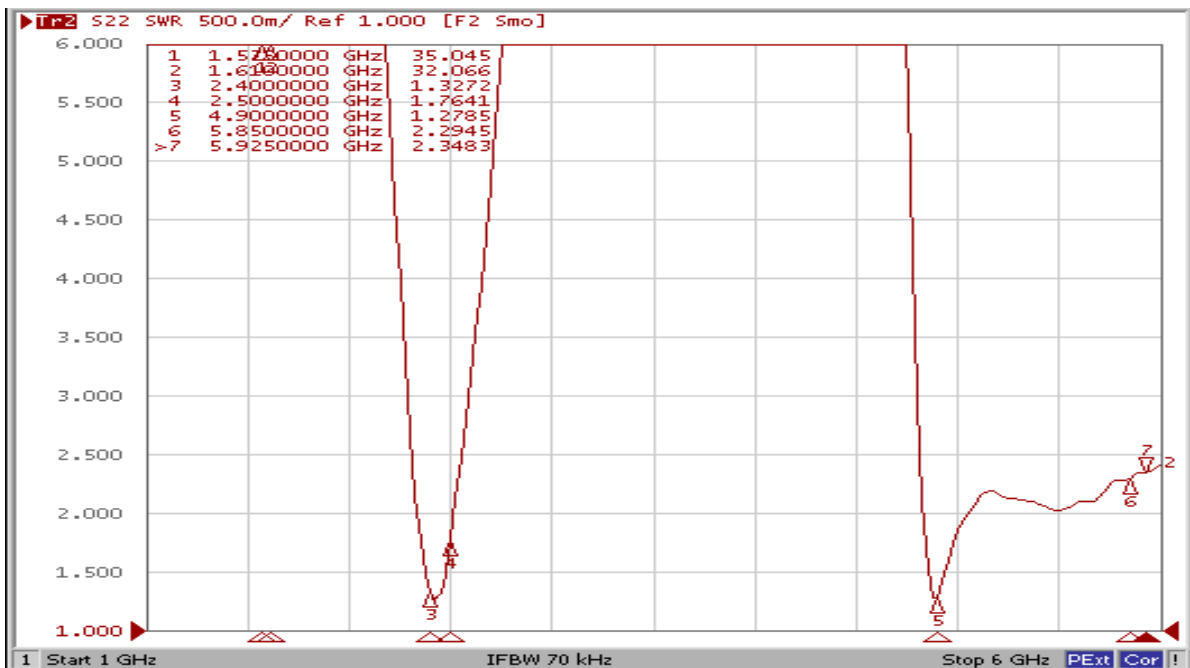

Issue: 1804

In the effort to improve our products, we reserve the right to make changes judged to be necessary.

CONFIDENTIAL AND PROPRIETARY INFORMATION

This document contains confidential and proprietary information of Pulse Electronics, Inc. (Pulse) and is protected by copyright, trade secret and other state and federal laws. Its receipt or possession does not convey any rights to reproduce, disclose its contents, or to manufacture, use or sell anything it may describe. Reproduction, disclosure or use without specific written authorization of Pulse is strictly forbidden.

Description: GNSS-DUAL WIFI-DSRC ANT

Series: CERAMIC CHIP

PART NUMBER: W3095

CHARTS

Typical Isolation

Isolation

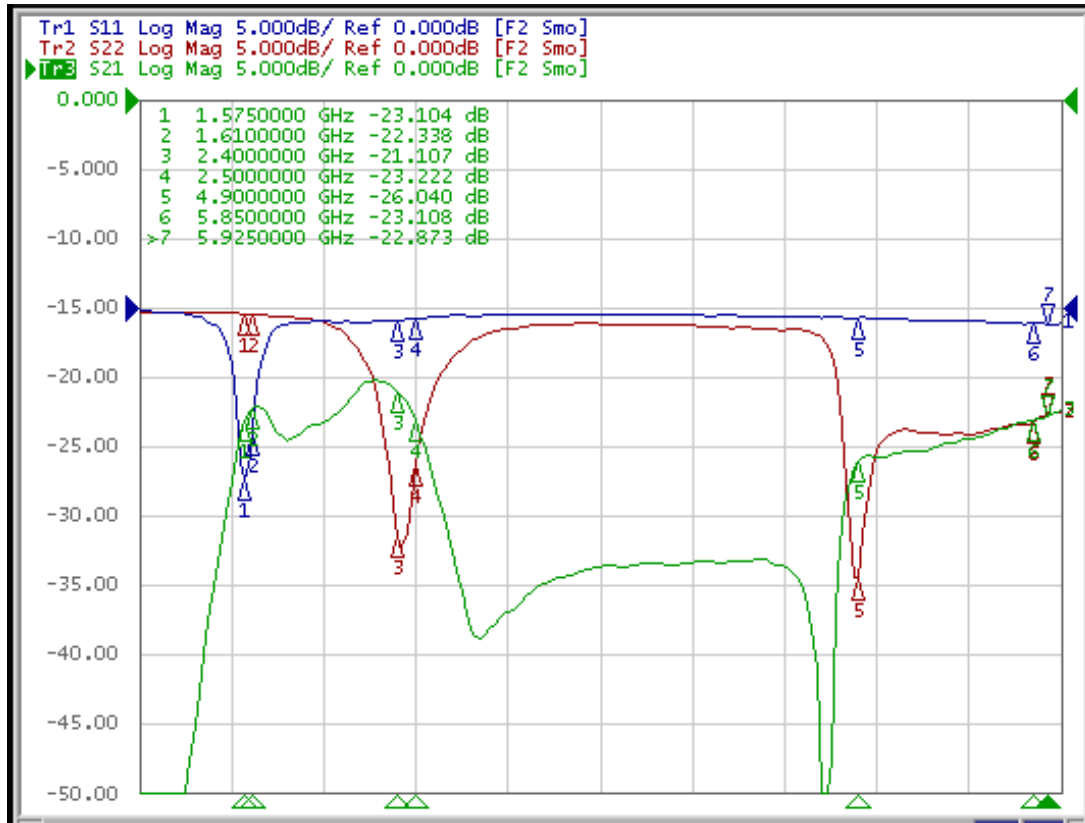

Issue: 1804

In the effort to improve our products, we reserve the right to make changes judged to be necessary.

CONFIDENTIAL AND PROPRIETARY INFORMATION

This document contains confidential and proprietary information of Pulse Electronics, Inc. (Pulse) and is protected by copyright, trade secret and other state and federal laws. Its receipt or possession does not convey any rights to reproduce, disclose its contents, or to manufacture, use or sell anything it may describe. Reproduction, disclosure or use without specific written authorization of Pulse is strictly forbidden.

Description: GNSS-DUAL WIFI-DSRC ANT

Series: CERAMIC CHIP

PART NUMBER: W3095

CHARTS

Typical Antenna Total Efficiency

GPS/GLONASS

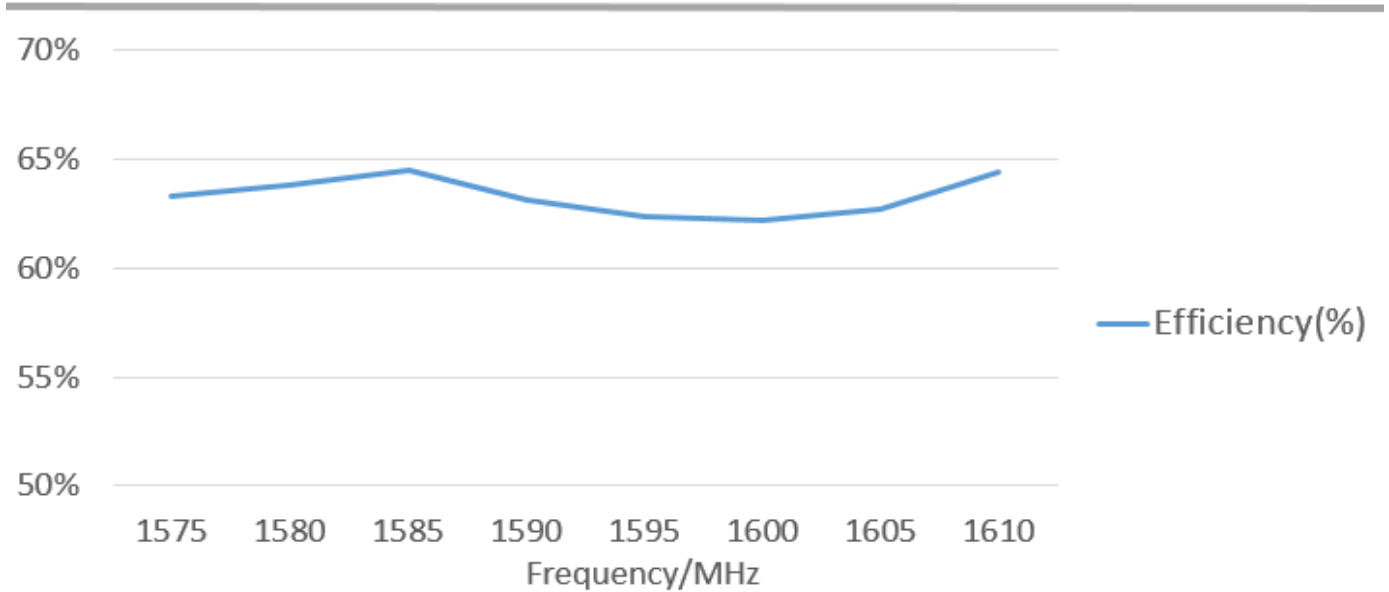

WIFI/DSRC

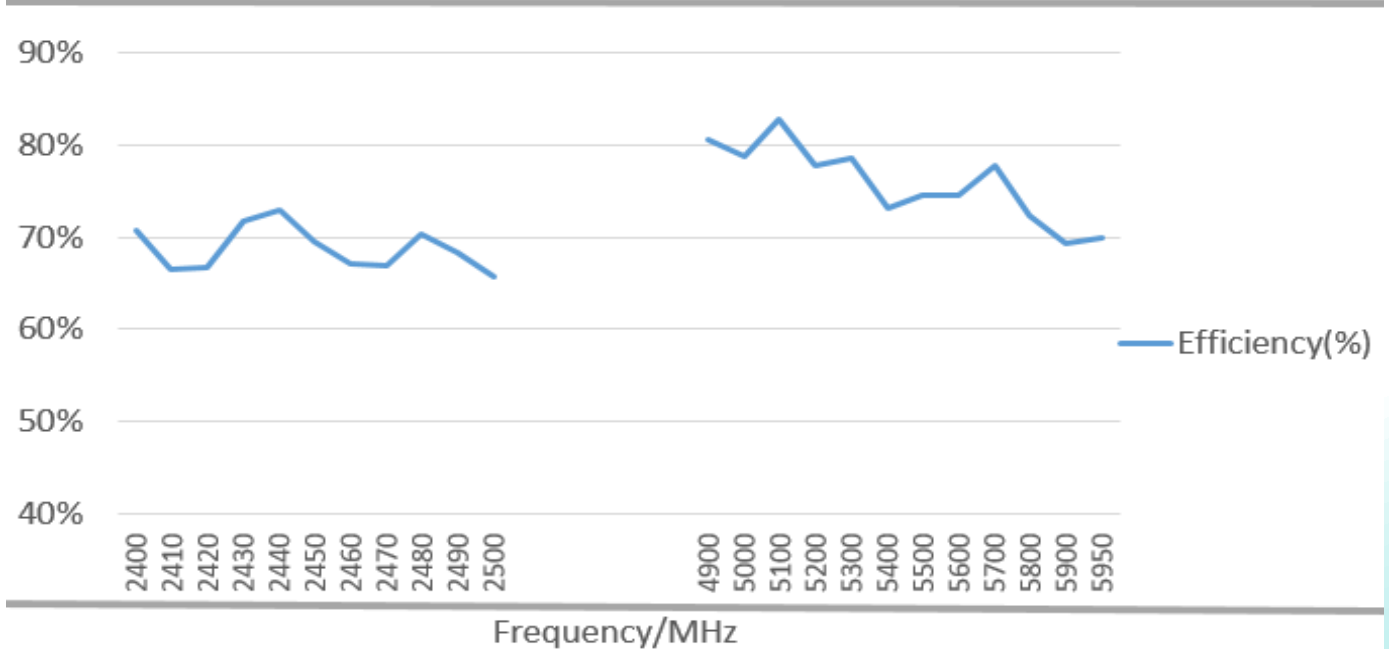

Issue: 1804

In the effort to improve our products, we reserve the right to make changes judged to be necessary.

CONFIDENTIAL AND PROPRIETARY INFORMATION

This document contains confidential and proprietary information of Pulse Electronics, Inc. (Pulse) and is protected by copyright, trade secret and other state and federal laws. Its receipt or possession does not convey any rights to reproduce, disclose its contents, or to manufacture, use or sell anything it may describe. Reproduction, disclosure or use without specific written authorization of Pulse is strictly forbidden.



Description: GNSS-DUAL WIFI-DSRC ANT

Series: CERAMIC CHIP

PART NUMBER: W3095

CHARTS

Typical Antenna Peak Gain

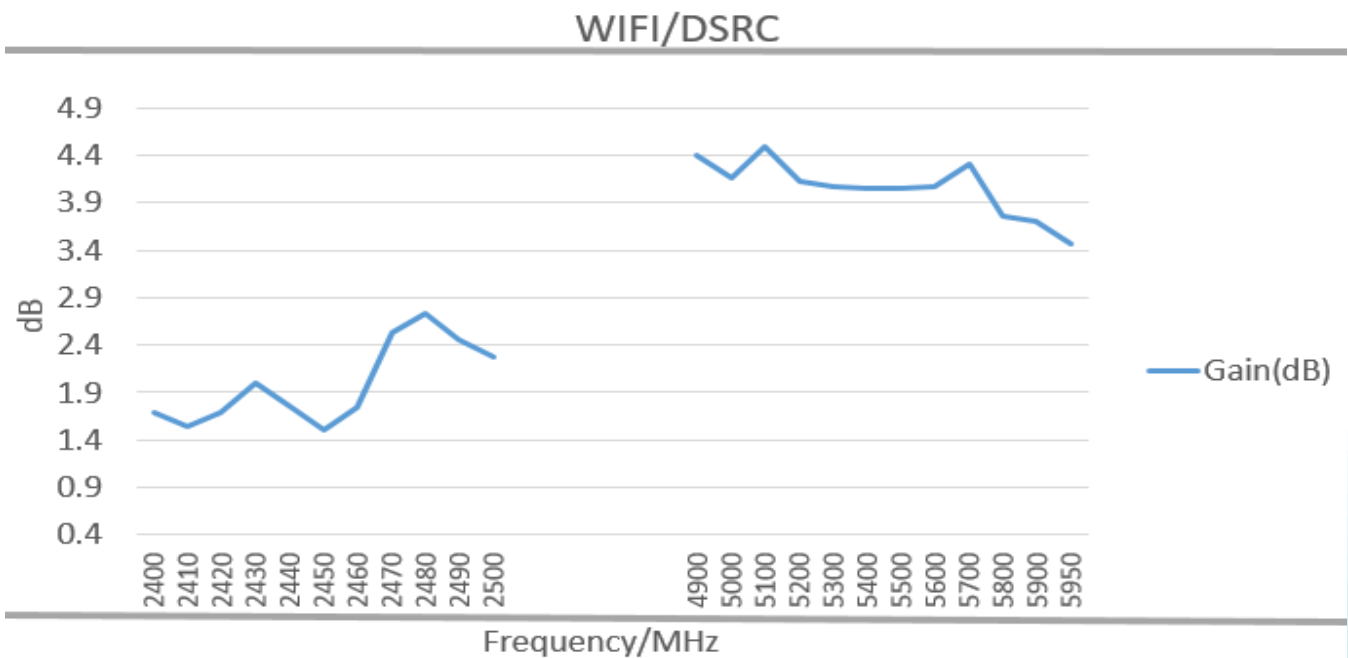
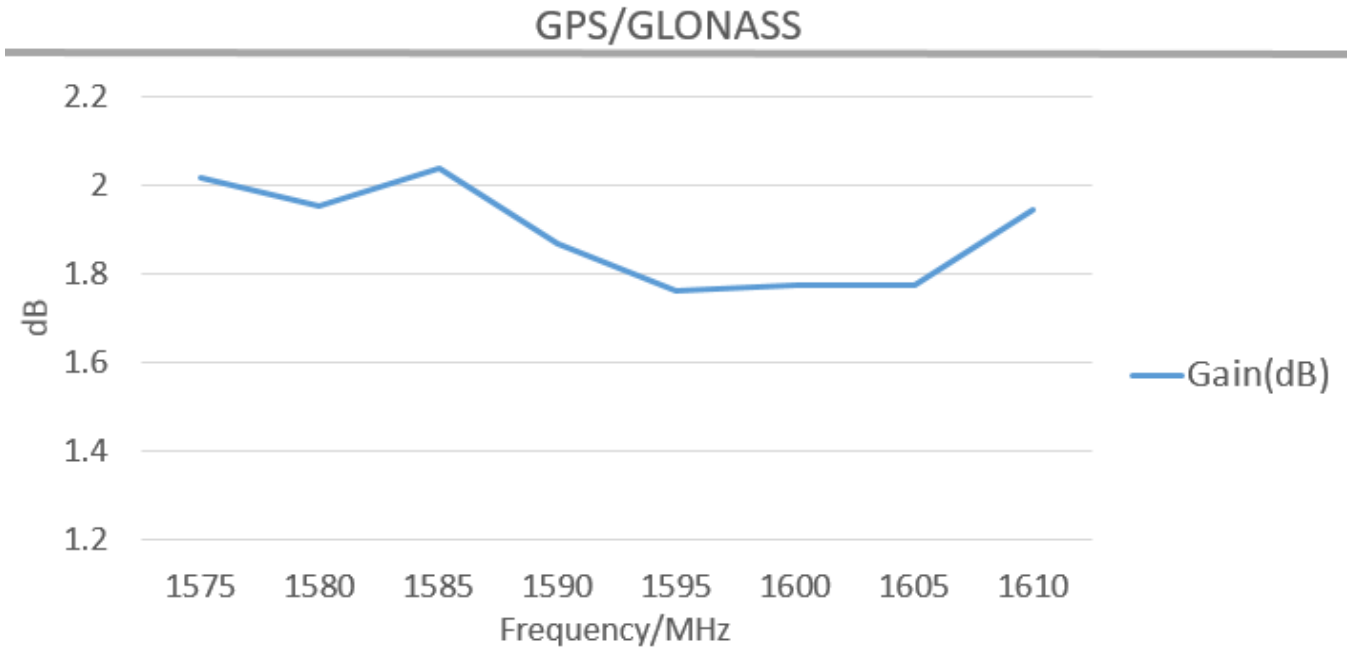

Issue: 1804

In the effort to improve our products, we reserve the right to make changes judged to be necessary.

CONFIDENTIAL AND PROPRIETARY INFORMATION

This document contains confidential and proprietary information of Pulse Electronics, Inc. (Pulse) and is protected by copyright, trade secret and other state and federal laws. Its receipt or possession does not convey any rights to reproduce, disclose its contents, or to manufacture, use or sell anything it may describe. Reproduction, disclosure or use without specific written authorization of Pulse is strictly forbidden.



Description: GNSS-DUAL WIFI-DSRC ANT

Series: CERAMIC CHIP

PART NUMBER: W3095

CHARTS

Typical free space radiation pattern—GPS/GLONASS

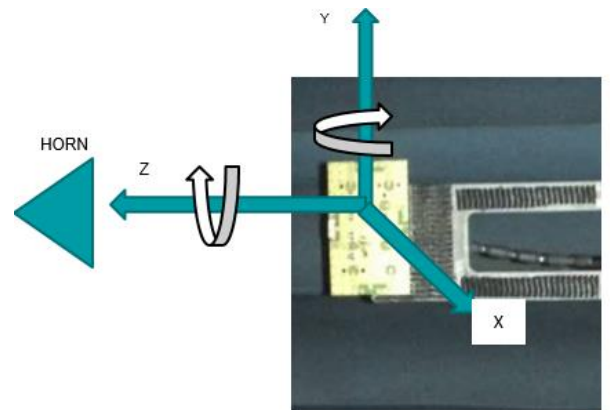
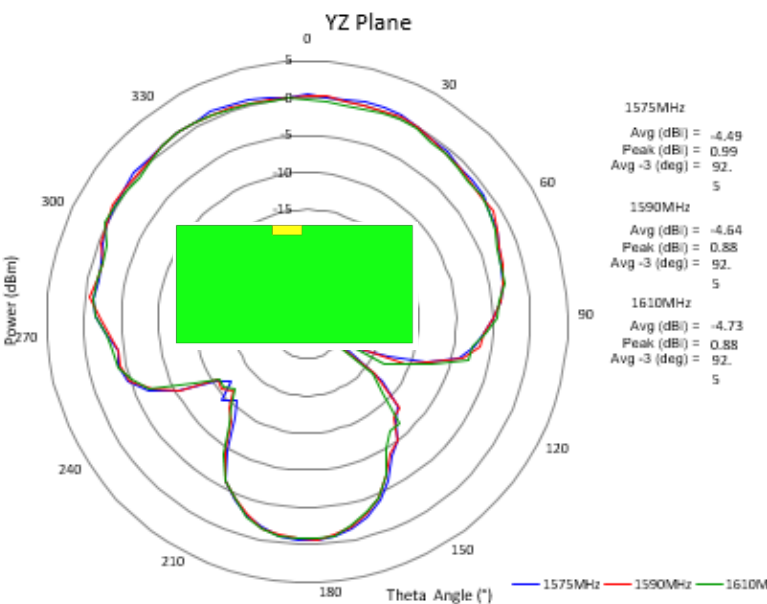
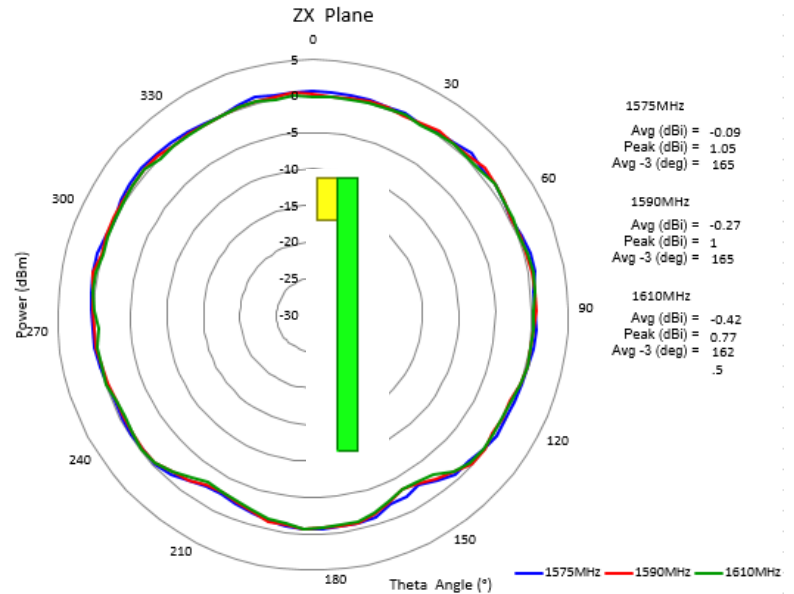
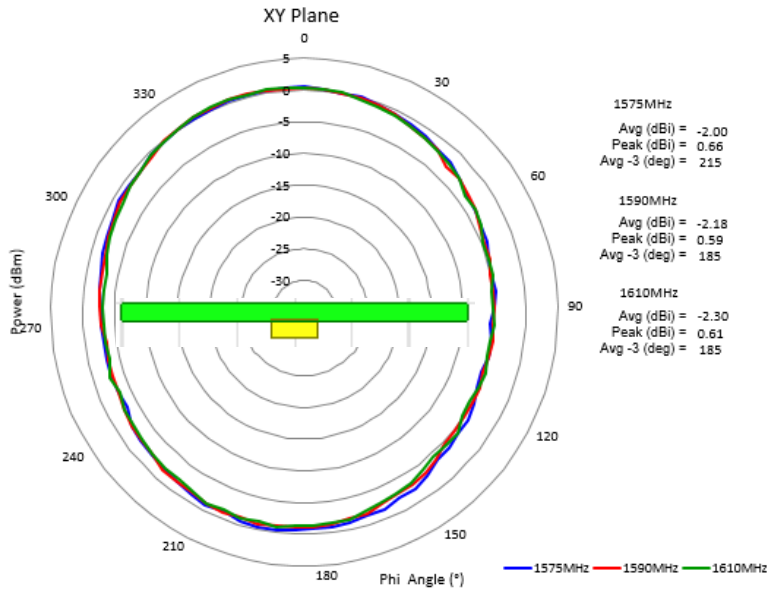

Issue: 1804

In the effort to improve our products, we reserve the right to make changes judged to be necessary.

CONFIDENTIAL AND PROPRIETARY INFORMATION

This document contains confidential and proprietary information of Pulse Electronics, Inc. (Pulse) and is protected by copyright, trade secret and other state and federal laws. Its receipt or possession does not convey any rights to reproduce, disclose its contents, or to manufacture, use or sell anything it may describe. Reproduction, disclosure or use without specific written authorization of Pulse is strictly forbidden.

Description: GNSS-DUAL WIFI-DSRC ANT

Series: CERAMIC CHIP

PART NUMBER: W3095

CHARTS

Typical free space radiation pattern—2.4G

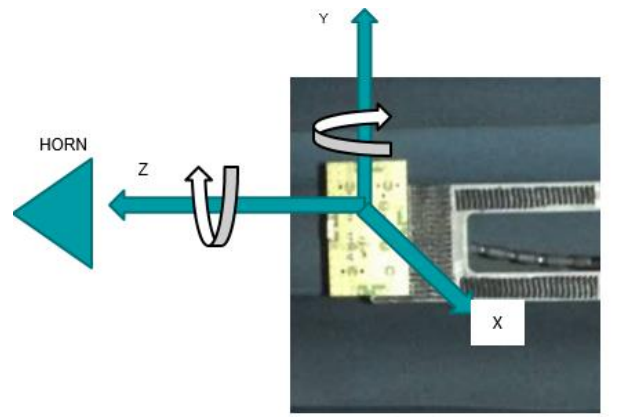
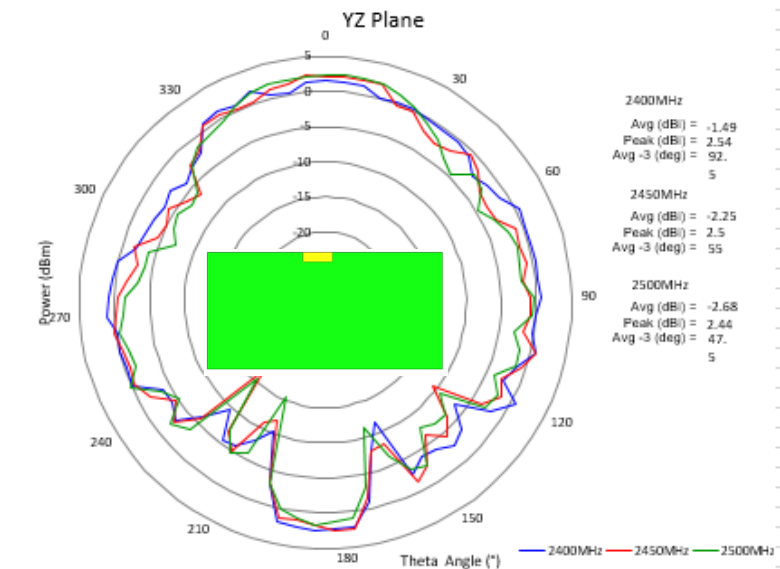
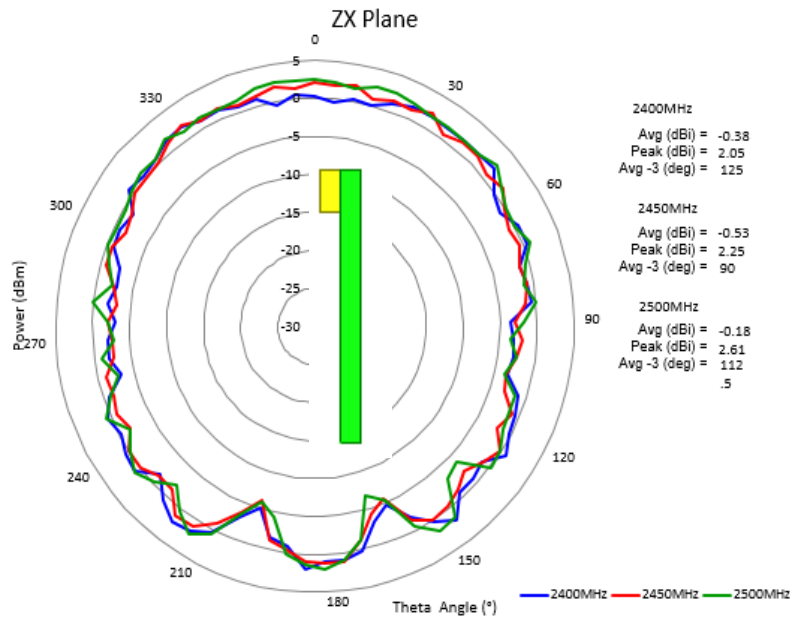
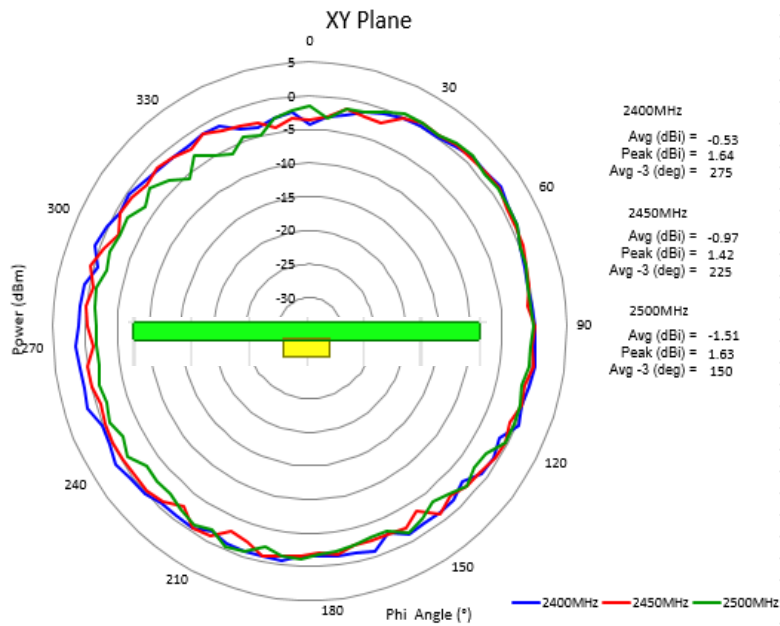

Issue: 1804

In the effort to improve our products, we reserve the right to make changes judged to be necessary.
CONFIDENTIAL AND PROPRIETARY INFORMATION

This document contains confidential and proprietary information of Pulse Electronics, Inc. (Pulse) and is protected by copyright, trade secret and other state and federal laws. Its receipt or possession does not convey any rights to reproduce, disclose its contents, or to manufacture, use or sell anything it may describe. Reproduction, disclosure or use without specific written authorization of Pulse is strictly forbidden.

Description: GNSS-DUAL WIFI-DSRC ANT

Series: CERAMIC CHIP

PART NUMBER: W3095

CHARTS

Typical free space radiation pattern—5G

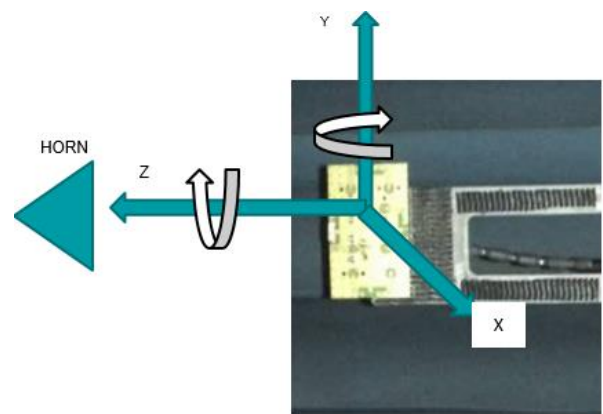
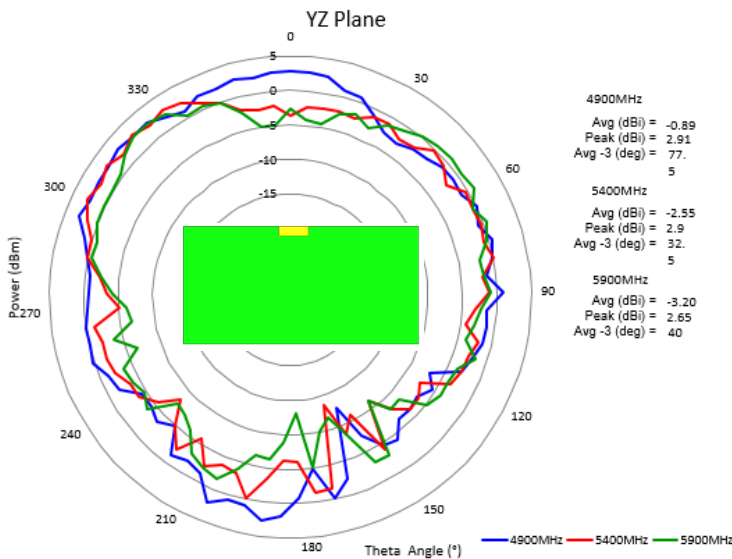
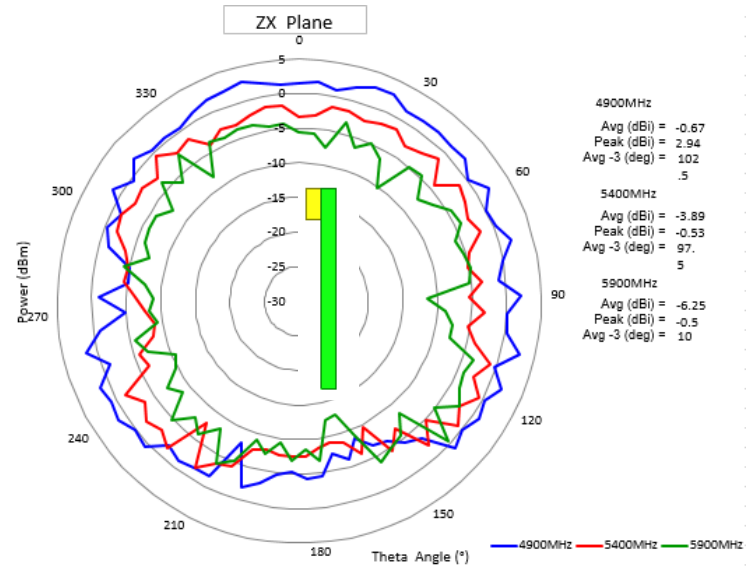
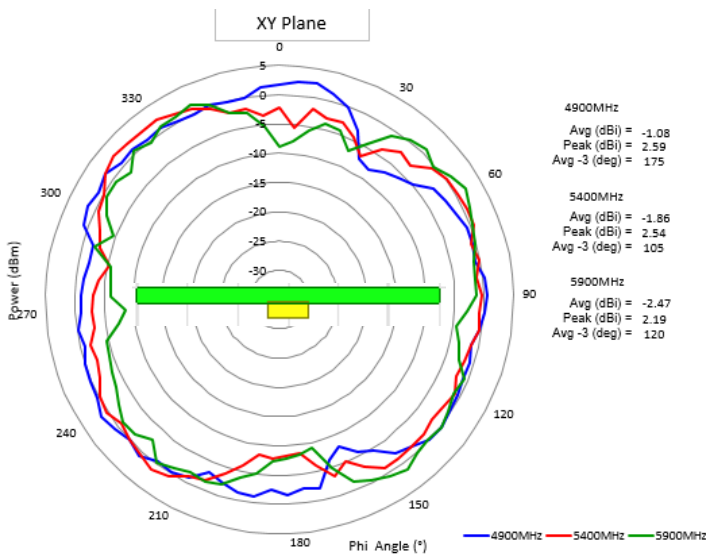

Issue: 1804

In the effort to improve our products, we reserve the right to make changes judged to be necessary.

CONFIDENTIAL AND PROPRIETARY INFORMATION

This document contains confidential and proprietary information of Pulse Electronics, Inc. (Pulse) and is protected by copyright, trade secret and other state and federal laws. Its receipt or possession does not convey any rights to reproduce, disclose its contents, or to manufacture, use or sell anything it may describe. Reproduction, disclosure or use without specific written authorization of Pulse is strictly forbidden.

Description: GNSS-DUAL WIFI-DSRC ANT

Series: CERAMIC CHIP

PART NUMBER: W3095

PACKAGING

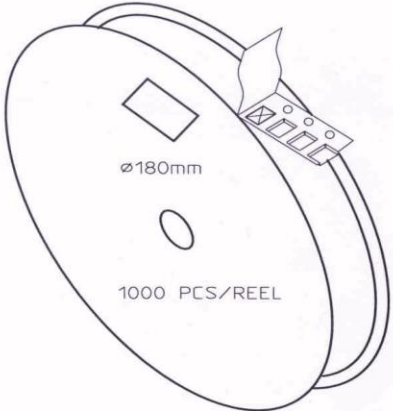

CARRIER TAPE H85-00188
 width=24,00 depth=2.20
 COVER TAPE H85-00159
 width=21.20

LENGTH OF TAPE:

- Leader section: min 350 mm before component section
- Trailer section: min 40 mm after component section.

Empty part cavities at leader and trailer section of the tape must be sealed with top cover tape.

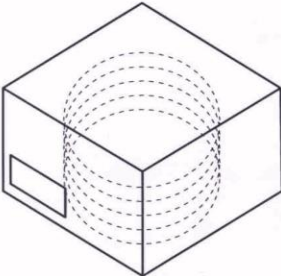

BOX H85-00128 (182x182x125)	1 pcs
- LABEL	1 pcs/BOX
REEL H85-00160 (D180, W28)	4 pcs
- REEL LABEL	1 pcs/REEL

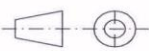
MATERIAL				
HANDLINGS				
 	RATIO	DRWN	160107 PeHa	H
		DGNER		G
PRODUCT			CHKD	F
H90-OY113-F01P01			APPRD	E
			APPRD BY	D
DENOMINATION				C
PACKING FORM				B
				A
		VERSION	MOD/DATE/NAME	

Issue: 1804

In the effort to improve our products, we reserve the right to make changes judged to be necessary.

CONFIDENTIAL AND PROPRIETARY INFORMATION

This document contains confidential and proprietary information of Pulse Electronics, Inc. (Pulse) and is protected by copyright, trade secret and other state and federal laws. Its receipt or possession does not convey any rights to reproduce, disclose its contents, or to manufacture, use or sell anything it may describe. Reproduction, disclosure or use without specific written authorization of Pulse is strictly forbidden.

Description: GNSS-DUAL WIFI-DSRC ANT

Series: CERAMIC CHIP

PART NUMBER: W3095

Block Orientation

Antenna soldering pads facing down to the bottom of the carrier tape

Top view of the carrier tape

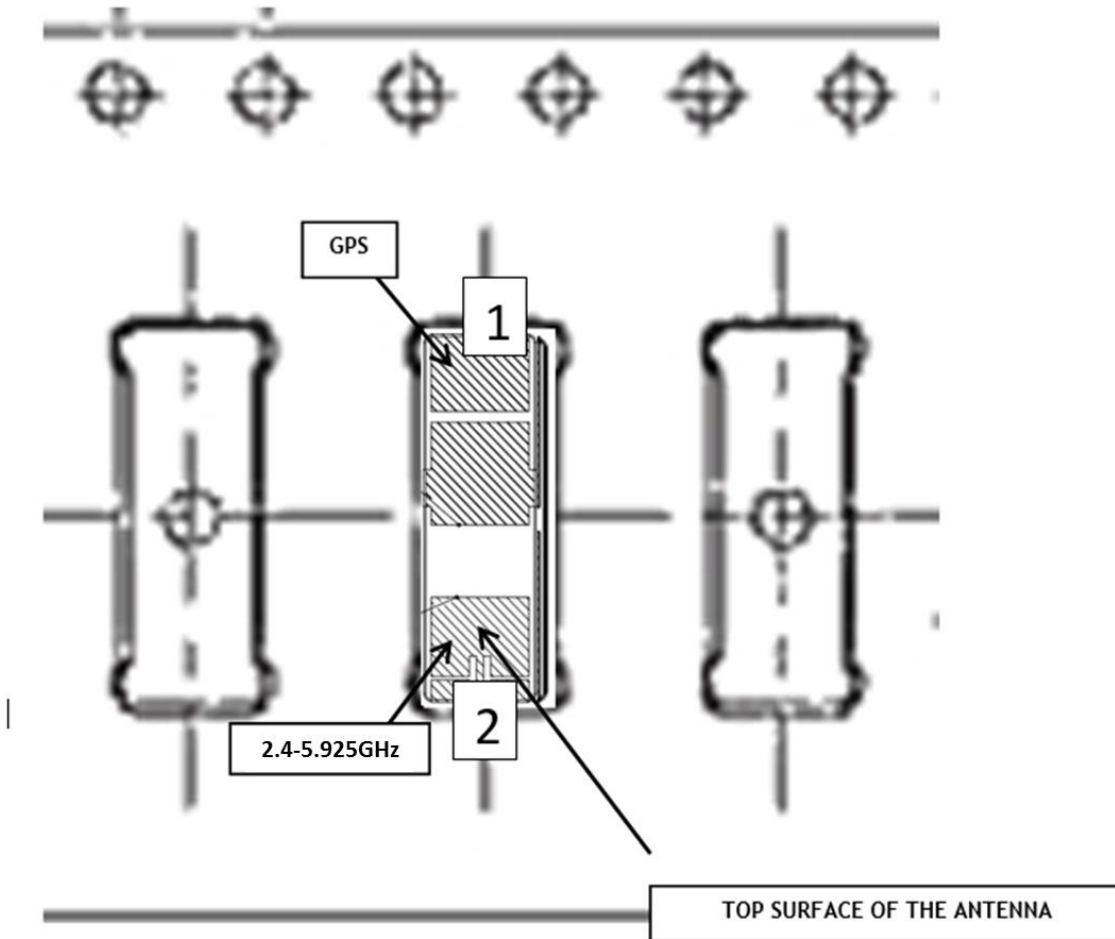

Issue: 1804

In the effort to improve our products, we reserve the right to make changes judged to be necessary.

CONFIDENTIAL AND PROPRIETARY INFORMATION

This document contains confidential and proprietary information of Pulse Electronics, Inc. (Pulse) and is protected by copyright, trade secret and other state and federal laws. Its receipt or possession does not convey any rights to reproduce, disclose its contents, or to manufacture, use or sell anything it may describe. Reproduction, disclosure or use without specific written authorization of Pulse is strictly forbidden.

X-ON Electronics

Largest Supplier of Electrical and Electronic Components

Click to view similar products for [Antenna Development Tools](#) category:

Click to view products by [PulseLarsen](#) manufacturer:

Other Similar products are found below :

[0868AT43A0020-EB1SMA](#) [EVALBGSA141MN10TOBO1](#) [A10393-U1](#) [PCSD.06.A](#) [B5771-U1](#) [KIT-LTE-GNSS-01](#) [KIT-WIFI-ISM-01](#)
[A10472-U1](#) [REFLECTOR-EVB-1](#) [A10340-U1](#) [ACAG0201-2450-EVB](#) [ACAG0301-15752450-EVB](#) [ACAG0301-1575-EVB](#) [ACAG0301-24505500-EVB](#) [ACAG0301-5500-EVB](#) [ACAG0801-2450-EVB](#) [ACAG1204-433-EVB](#) [ACAG1204-868-EVB](#) [ACAG1204-915-EVB](#)
[ACAR0301-SW2-EVB](#) [ACAR3005-C2WB-EVB](#) [ACAR3005-S824-EVB](#) [ACAR3705-S698-EVB](#) [ACAR4008-S698-EVB](#) [A10137-D](#)
[A10194-U1](#) [A10204-U1](#) [A5645H-EVB-1](#) [A5645-U1](#) [A5887H-EVB-1](#) [A6111-U1](#) [M20057-EVB-1](#) [SR42W001-U1](#) [SR42W009-U1](#)
[SR4G008-U1](#) [SR4G013-U1](#) [SR4G053-EVB-1](#) [SR4L049-EVB-1](#) [SRC5G027-U1](#) [SRCW004-U1](#) [1001312-01](#) [M310220-01](#) [M620720-01](#)
[M830120-01](#) [M830520-01](#) [EB_NN01-105A](#) [EB_NN02-201-5G](#) [CCKLTE450-NA](#) [AEK-GNCP-TH258L15](#) [MPA-104- KIT](#)