

Description: Ceramic Patch Antenna, 40x40x6.6mm
PIN Mount, GNSS/IRIDIUM

Series: Patch Antenna

PART NUMBER: W3227



Features:

- Center Frequency 1621 MHz
- Band Width 177MHz
- Polarization RHCP
- Gain 4dBic
- Size 1.575 x 1.575 x 0.26"

Applications:

- Satellite signal reception
- Iridium
- GNSS (Beidou, GPS, Galileo, Glonass)
- Timing Antennas
- Tracking
- Asset Management

All dimensions are in mm / inches

Issue: 1905

In the effort to improve our products, we reserve the right to make changes judged to be necessary.

CONFIDENTIAL AND PROPRIETARY INFORMATION

This document contains confidential and proprietary information of Pulse Electronics, Inc. (Pulse) and is protected by copyright, trade secret and other state and federal laws. Its receipt or possession does not convey any rights to reproduce, disclose its contents, or to manufacture, use or sell anything it may describe. Reproduction, disclosure or use without specific written authorization of Pulse is strictly forbidden.

For more information:

Pulse Worldwide Headquarters
15255 Innovation Drive #100
San Diego, CA 92128
USA
Tel: 1-858-674-8100

Pulse/Larsen Antennas
18110 SE 34th St Bldg 2 Suite 250
Vancouver, WA 98683
USA
Tel: 1-360-944-7551

Europe Headquarters
Pulse GmbH & Do, KG
Zeppelinstrasse 15
Herrenberg, Germany
Tel: 49 7032 7806 0

Pulse (Suzhou) Wireless Products Co, Inc.
99 Huo Ju Road(#29 Bldg,4th Phase
Suzhou New District
Jiangsu Province, Suzhou 215009 PR China
Tel: 86 512 6807 9998



Description: Ceramic Patch Antenna, 40x40x6.6mm
PIN Mount, GNSS/IRIDIUM

Series: Patch Antenna

PART NUMBER: W3227

ELECTRICAL SPECIFICATIONS*

Antenna Type	Ceramic Patch antenna
Center Frequency	1621MHz \pm 10MHz
Frequency band	1532-1709MHz
Nominal Impedance	50 Ω
VSWR in whole band	<3.5:1
VSWR at center frequency	<1.7:1
Peak RHCP Gain at Zenith	>4dBic at center frequency
Half Power Beam Width	110° Solid angle
Efficiency	60% typical
Polarization	RHCP

* All test on 63X63mm ground plane

MECHANICAL SPECIFICATIONS

Overall Length	1.575 x 1.575 x 0.26"
Weight	35.8 g
Antenna Color / Material	White

ENVIRONMENTAL SPECIFICATIONS

Operating Temperature	-40°C to +105°C
Storage Temperature	-40°C to +105°C

Description: Ceramic Patch Antenna, 40x40x6.6mm
PIN Mount, GNSS/IRIDIUM

Series: Patch Antenna

PART NUMBER: W3227

MECHANICAL DRAWING

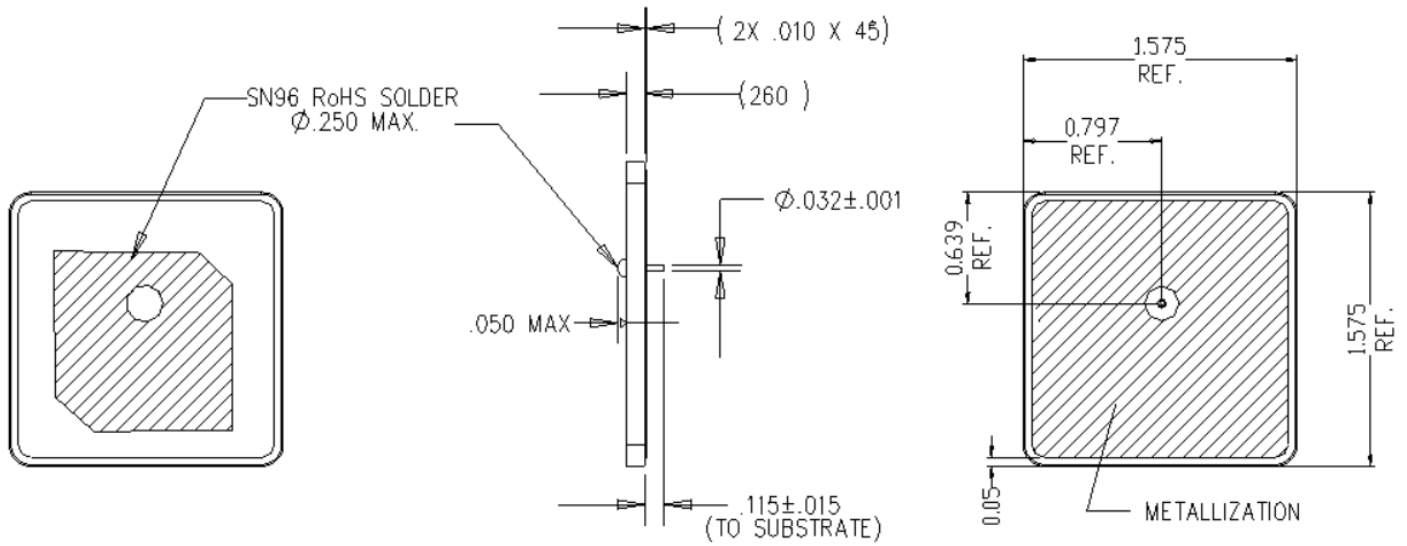

Issue: 1905

In the effort to improve our products, we reserve the right to make changes judged to be necessary.

CONFIDENTIAL AND PROPRIETARY INFORMATION

This document contains confidential and proprietary information of Pulse Electronics, Inc. (Pulse) and is protected by copyright, trade secret and other state and federal laws. Its receipt or possession does not convey any rights to reproduce, disclose its contents, or to manufacture, use or sell anything it may describe. Reproduction, disclosure or use without specific written authorization of Pulse is strictly forbidden.

Description: Ceramic Patch Antenna, 40x40x6.6mm
PIN Mount, GNSS/IRIDIUM

Series: Patch Antenna

PART NUMBER: W3227

TEST SETUP

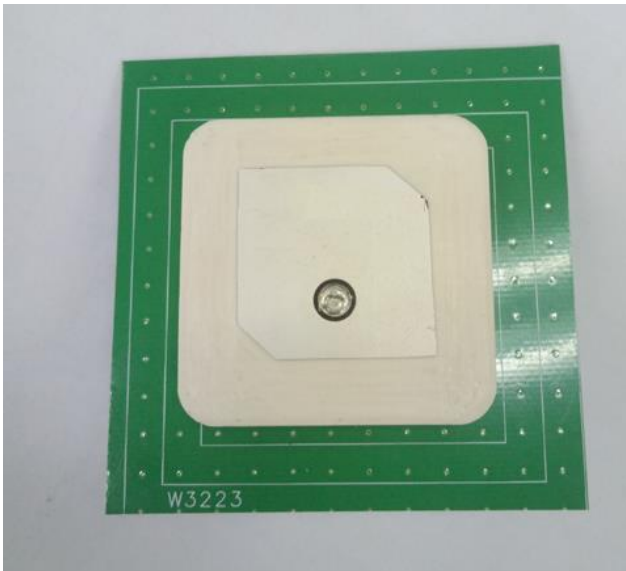

For VSWR
On 63X63 mm ground plane

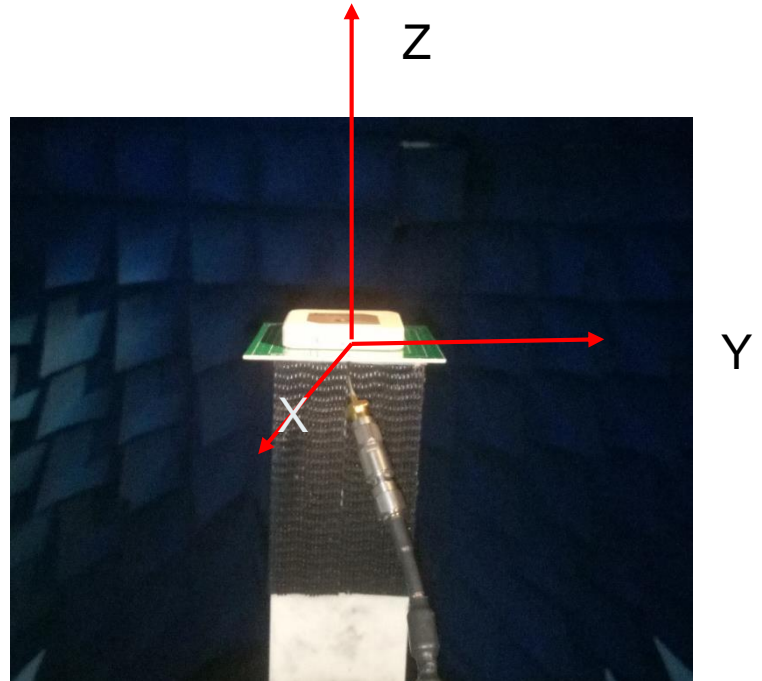

In Chamber

Description: Ceramic Patch Antenna, 40x40x6.6mm
PIN Mount, GNSS/IRIDIUM

Series: Patch Antenna

PART NUMBER: W3227

CHARTS

VSWR

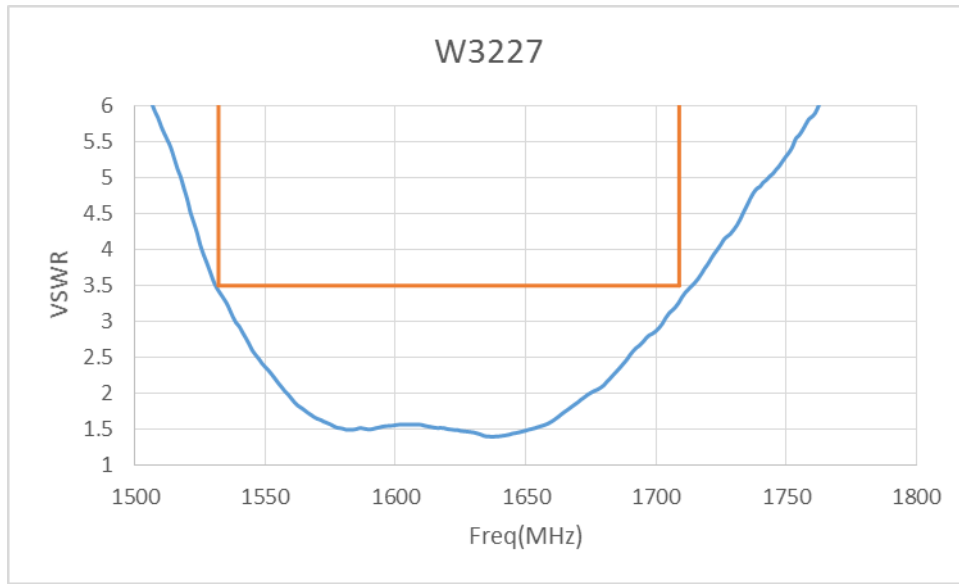

Radiation Efficiency

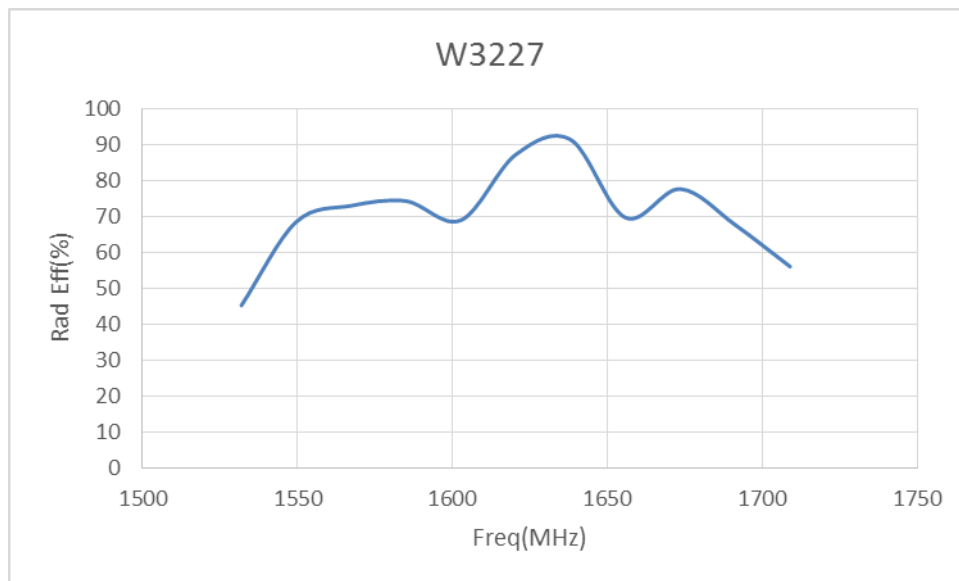

Issue: 1905

In the effort to improve our products, we reserve the right to make changes judged to be necessary.

CONFIDENTIAL AND PROPRIETARY INFORMATION

This document contains confidential and proprietary information of Pulse Electronics, Inc. (Pulse) and is protected by copyright, trade secret and other state and federal laws. Its receipt or possession does not convey any rights to reproduce, disclose its contents, or to manufacture, use or sell anything it may describe. Reproduction, disclosure or use without specific written authorization of Pulse is strictly forbidden.

Description: Ceramic Patch Antenna, 40x40x6.6mm
PIN Mount, GNSS/IRIDIUM

Series: Patch Antenna

PART NUMBER: W3227

CHARTS

RHCP Gain at Zenith

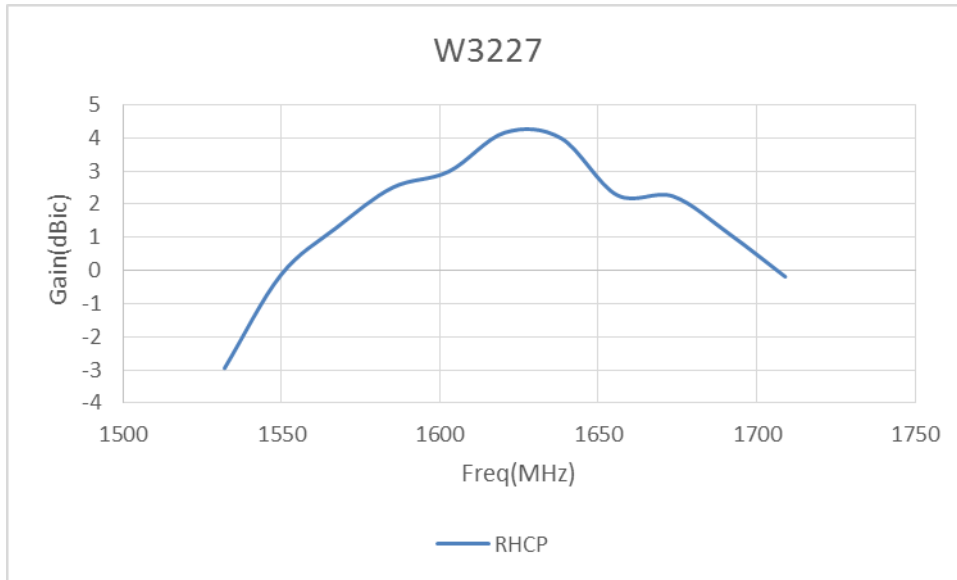

Radiation Pattern

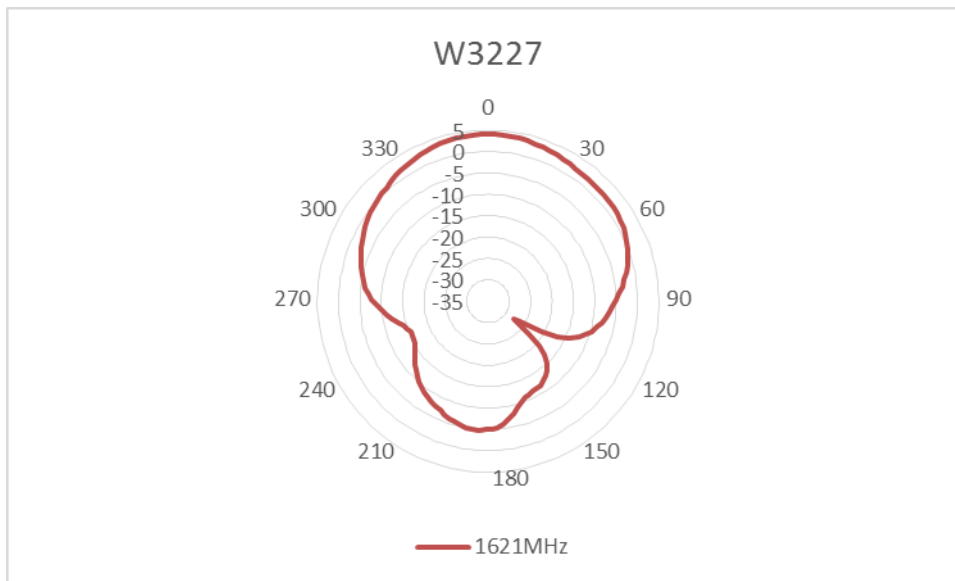

Issue: 1905

In the effort to improve our products, we reserve the right to make changes judged to be necessary.

CONFIDENTIAL AND PROPRIETARY INFORMATION

This document contains confidential and proprietary information of Pulse Electronics, Inc. (Pulse) and is protected by copyright, trade secret and other state and federal laws. Its receipt or possession does not convey any rights to reproduce, disclose its contents, or to manufacture, use or sell anything it may describe. Reproduction, disclosure or use without specific written authorization of Pulse is strictly forbidden.

Description: Ceramic Patch Antenna, 40x40x6.6mm
PIN Mount, GNSS/IRIDIUM

Series: Patch Antenna

PART NUMBER: W3227

PACKAGING

30pcs antennas per tray
 4 trays of antennas (total 120pcs) packed in a vacuum bag.
 A label adhered on the vacuum bag with the P/N, Q'ty, Date and Shift information.
 4 vacuum bags of antennas (total 480pcs) pack in a carton.
 A label adhered on the carton with the P/N, Q'ty, WP, Date and Shift information



P/N:	W3227
Q'ty:	120 PCS
Date:	24-01-2019
Shift:	L



Issue: 1905

In the effort to improve our products, we reserve the right to make changes judged to be necessary.

CONFIDENTIAL AND PROPRIETARY INFORMATION

This document contains confidential and proprietary information of Pulse Electronics, Inc. (Pulse) and is protected by copyright, trade secret and other state and federal laws. Its receipt or possession does not convey any rights to reproduce, disclose its contents, or to manufacture, use or sell anything it may describe. Reproduction, disclosure or use without specific written authorization of Pulse is strictly forbidden.

X-ON Electronics

Largest Supplier of Electrical and Electronic Components

Click to view similar products for [Antennas](#) category:

Click to view products by [PulseLarsen](#) manufacturer:

Other Similar products are found below :

[GAN30084EU](#) [930-033-R](#) [GW17.07.0250E](#) [1513563-1](#) [EXE902SM](#) [APAMPG-117](#) [MAF94383](#) [W3908B0100](#) [W6102B0100](#) [YE572113-30RSMM](#) [108-00014-50](#) [66089-2406](#) [SPDA17RP918](#) [A09-F8NF-M](#) [A09-F5NF-M](#) [RGFRA1903041A1T](#) [W3593B0100](#) [W3921B0100](#) [SIMNA-868](#) [SIMNA-915](#) [SIMNA-433](#) [W1044](#) [W1049B090](#) [A75-001](#) [WTL2449CQ1-FRSMM](#) [CPL9C](#) [EXB148BN](#) [0600-00060](#) [TRA9020S3PBN-001](#) [Y4503](#) [GD5W-28P-NF](#) [MA9-7N](#) [GD53-25](#) [GD5W-21P-NF](#) [C37](#) [MAF94051](#) [MA9-5N](#) [EXD420PL](#) [B1322NR](#) [QWFTB120](#) [MAF94271](#) [MAF94300](#) [GPSMB301](#) [FG4403](#) [AO-AGSM-OM54](#) [5200232](#) [MIKROE-2349](#) [WCM.01.0111](#) [MIKROE-2393](#) [MIKROE-2352](#)