

# PT2301A

-20V P-Channel Enhancement-Mode MOSFET

**VDS= -20V**

**RDS(ON), Vgs@-4.5V, Ids@-3.0A < 110mΩ**

**RDS(ON), Vgs@-2.5V, Ids@-2.0A < 140mΩ**

## Features

Advanced trench process technology

High Density Cell Design For Ultra Low On-Resistance

## Package Dimensions

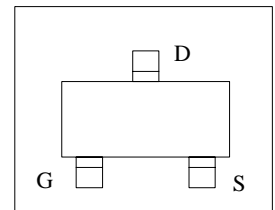
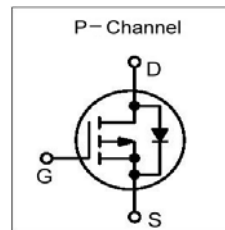
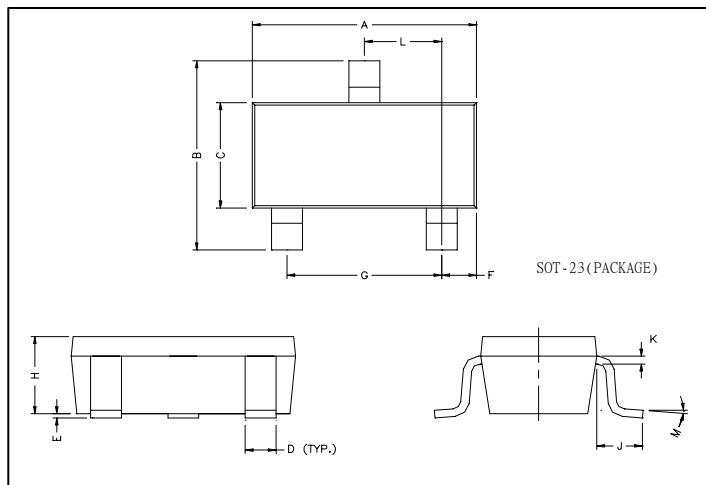

REF.	Millimeter		REF.	Millimeter	
	Min.	Max.		Min.	Max.
A	2.70	3.10	G	1.90	REF.
B	2.40	2.80	H	1.00	1.30
C	1.40	1.60	K	0.10	0.20
D	0.35	0.50	J	0.40	-
E	0	0.10	L	0.85	1.15
F	0.45	0.55	M	0°	10°

## Maximum Ratings and Thermal Characteristics (TA = 25°C unless otherwise noted)

Parameter	Symbol	Limit	Unit	
Drain-Source Voltage	$V_{DS}$	-20	V	
Gate-Source Voltage	$V_{GS}$	±10		
Continuous Drain Current	$I_D$	-3	A	
Pulsed Drain Current <sup>1)</sup>	$I_{DM}$	-10		
Maximum Power Dissipation <sup>2)</sup>		TA = 25°	1.25	W
		TA = 75°C	0.8	
Operating Junction and Storage Temperature Range	$T_J, T_{stg}$	-55 to 150	°C	
Junction-to-Ambient Thermal Resistance (PCB mounted) <sup>2)</sup>	$R_{thJA}$	100	°C/W	
Junction-to-Ambient Thermal Resistance (PCB mounted) <sup>3)</sup>		166		

### Notes

- 1) Pulse width limited by maximum junction temperature.
- 2) Surface Mounted on FR4 Board,  $t \leq 5$  sec.
- 3) Surface Mounted on FR4 Board.

## ELECTRICAL CHARACTERISTICS

Parameter	Symbol	Test Condition	Min.	Typ.	Max.	Unit
<b>Static</b>						
Drain-Source Breakdown Voltage	$BV_{DSS}$	$V_{GS} = 0V, I_D = -250\mu A$	-20			V
Drain-Source On-State Resistance <sup>1)</sup>	$R_{DS(on)}$	$V_{GS} = -4.5V, I_D = -3.0A$		64	110	$m\Omega$
		$V_{GS} = -2.5V, I_D = -2.0A$		89	140	
Gate Threshold Voltage	$V_{GS(th)}$	$V_{DS} = V_{GS}, I_D = -250\mu A$	-0.4		-1	V
Zero Gate Voltage Drain Current <sup>0</sup>	$I_{DSS}$	$V_{DS} = -20V, V_{GS} = 0V$			-1	$\mu A$
		$V_{DS} = -16V, V_{GS} = 0V, T_J = 55^\circ C$			-10	
Gate Body Leakage	$I_{GSS}$	$V_{GS} = \pm 10V, V_{DS} = 0V$			$\pm 100$	nA
Forward Transconductance <sup>1)</sup>	$g_{fs}$	$V_{DS} = -5V, I_D = -2.8A$		6.5	—	S
<b>Dynamic</b>						
Total Gate Charge	$Q_g$	$V_{DS} = -6V, I_D \cong -2.3A$ $V_{GS} = -4.5V$		5.8		nC
Gate-Source Charge	$Q_{gs}$			0.85		
Gate-Drain Charge	$Q_{gd}$			1.7		
Turn-On Delay Time	$t_{d(on)}$	$V_{DD} = -6V, R_L = 6\Omega$ $I_D \cong -1.0A, V_{GEN} = -4.5V$ $R_G = 6\Omega$		13		ns
Turn-On Rise Time	$t_r$			36		
Turn-Off Delay Time	$t_{d(off)}$			42		
Turn-Off Fall Time	$t_f$			34		
Input Capacitance	$C_{iss}$	$V_{DS} = -6V, V_{GS} = 0V$ $f = 1.0 MHz$		415		pF
Output Capacitance	$C_{oss}$			223		
Reverse Transfer Capacitance	$C_{rss}$			87		
<b>Source-Drain Diode</b>						
Max. Diode Forward Current	$I_S$				-1.6	A
Diode Forward Voltage	$V_{SD}$	$I_S = -1.0A, V_{GS} = 0V$		-0.8	-1.2	V

<sup>1)</sup> Pulse test: pulse width  $\leq 300\mu s$ , duty cycle  $\leq 2\%$

**TYPICAL ELECTRICAL AND THERMAL CHARACTERISTICS**

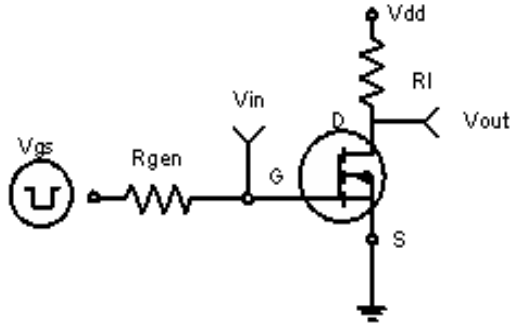

**Figure 1: Switching Test Circuit**

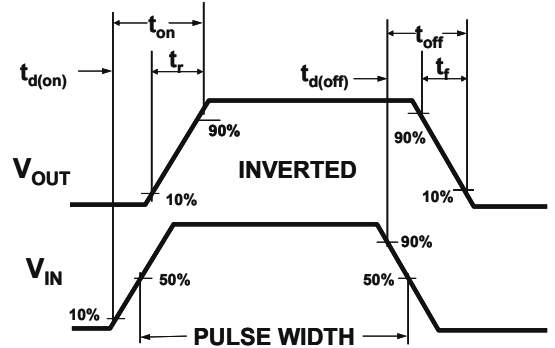

**Figure 2: Switching Waveforms**

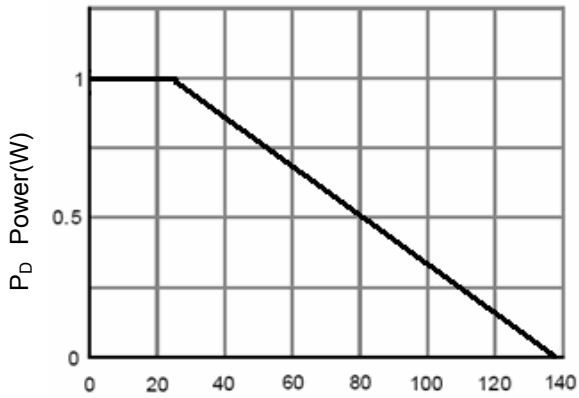

**Figure 3 Power Dissipation**

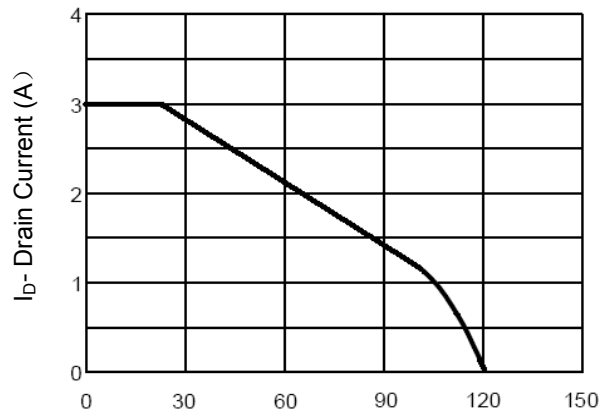

**Figure 4 Drain Current**

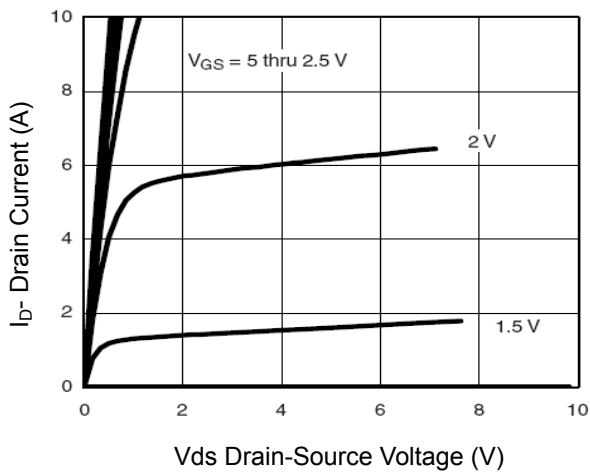

**Figure 5 Output CHARACTERISTICS**

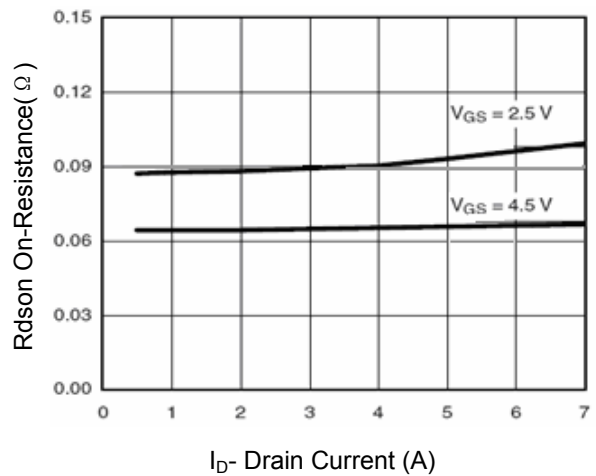

**Figure 6 Drain-Source On-Resistance**

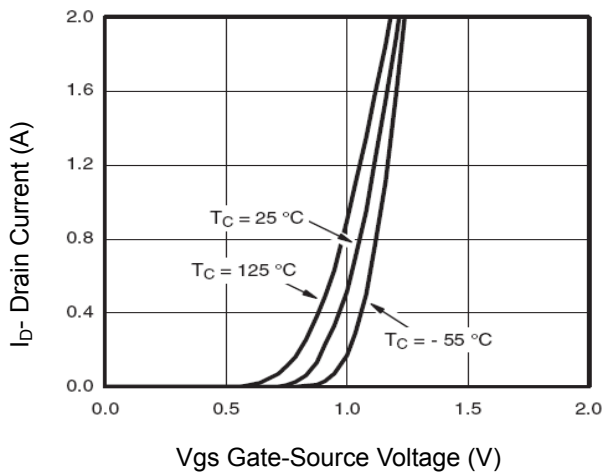

Figure 7 Transfer Characteristics

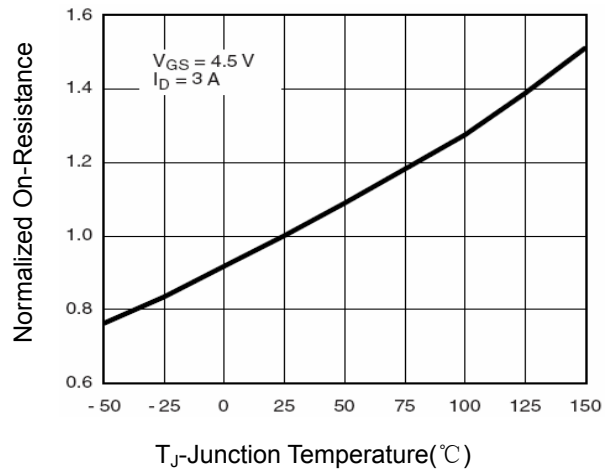

Figure 8 Drain-Source On-Resistance

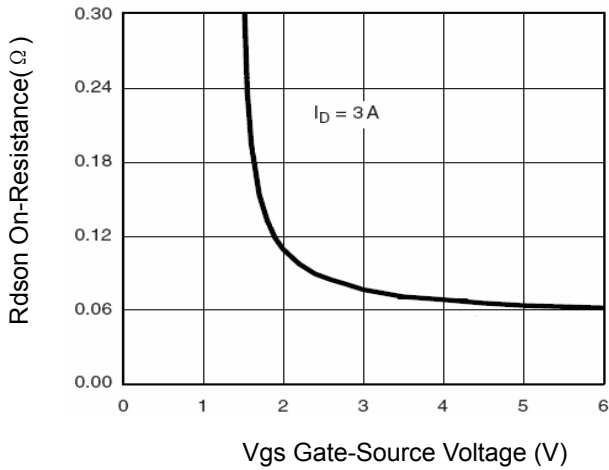

Figure 9  $R_{DS(on)}$  vs  $V_{GS}$

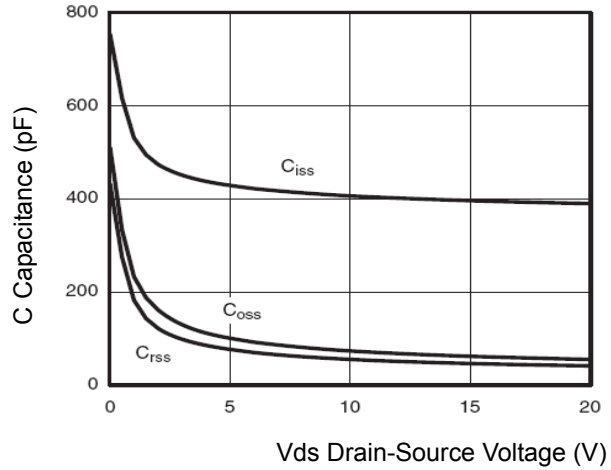

Figure 10 Capacitance vs  $V_{DS}$

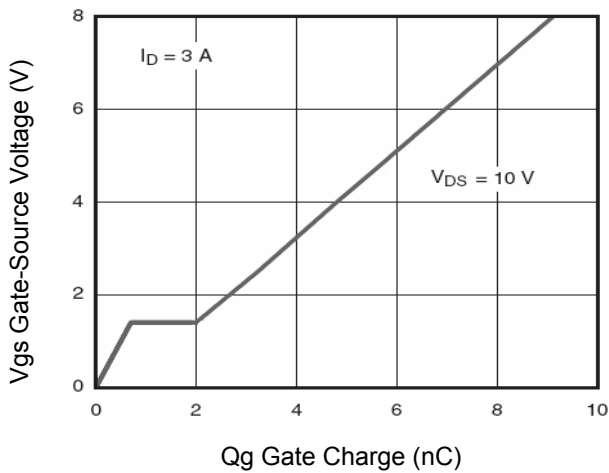

Figure 11 Gate Charge

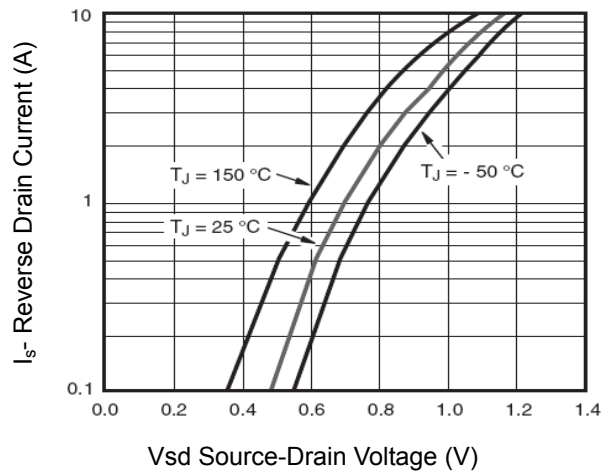

Figure 12 Source-Drain Diode Forward

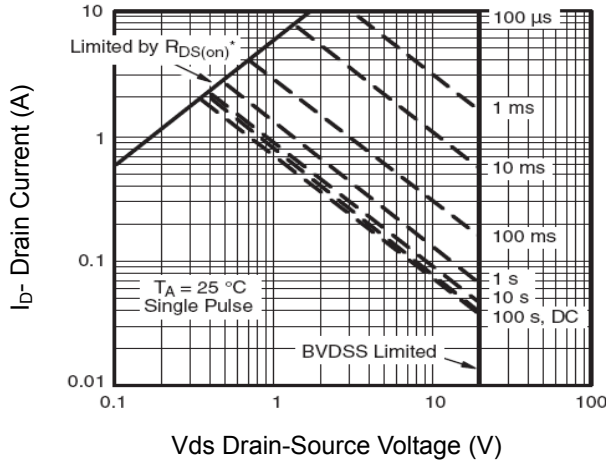

Figure 13 Safe Operation Area

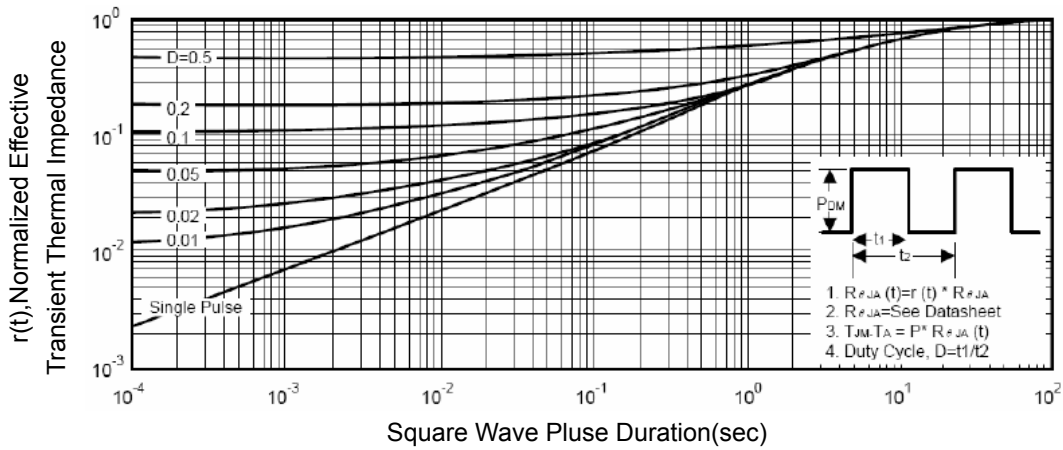

Figure 14 Normalized Maximum Transient Thermal Impedance

## X-ON Electronics

Largest Supplier of Electrical and Electronic Components

*Click to view similar products for [MOSFET](#) category:*

*Click to view products by [PUOLOP](#) manufacturer:*

Other Similar products are found below :

[614233C](#) [648584F](#) [IRFD120](#) [IRFF430](#) [JANTX2N5237](#) [2N7000](#) [FCA20N60\\_F109](#) [FDZ595PZ](#) [AOD464](#) [2SK2267\(Q\)](#) [2SK2545\(Q,T\)](#)  
[405094E](#) [423220D](#) [MIC4420CM-TR](#) [VN1206L](#) [614234A](#) [715780A](#) [SSM6J414TU,LF\(T](#) [751625C](#) [BSC884N03MS G](#) [BSF024N03LT3 G](#)  
[PSMN4R2-30MLD](#) [TK31J60W5,S1VQ\(O](#) [2SK2614\(TE16L1,Q\)](#) [DMN1017UCP3-7](#) [EFC2J004NUZTDG](#) [FCAB21350L1](#) [P85W28HP2F-](#)  
[7071](#) [DMN1053UCP4-7](#) [NTE2384](#) [NTE2969](#) [NTE6400A](#) [DMN2080UCB4-7](#) [DMN61D9UWQ-13](#) [US6M2GTR](#) [DMN31D5UDJ-7](#)  
[SSM6P54TU,LF](#) [DMP22D4UFO-7B](#) [IPS60R3K4CEAKMA1](#) [DMN1006UCA6-7](#) [DMN16M9UCA6-7](#) [STF5N65M6](#) [STU5N65M6](#)  
[C3M0021120D](#) [DMN13M9UCA6-7](#) [BSS340NWH6327XTSA1](#) [MCM3400A-TP](#) [DMTH10H4M6SPS-13](#) [IRF40SC240ARMA1](#)  
[IPS60R1K0PFD7SAKMA1](#)