

-20V P-Channel Enhancement Mode MOSFET

VDS= -20V

RDS(ON), Vgs@-4.5V, Ids@-4.1A < 52mΩ

RDS(ON), Vgs@-2.5V, Ids@-3.0A < 75mΩ

Features

Advanced trench process technology

High Density Cell Design For Ultra Low On-Resistance

Package Dimensions

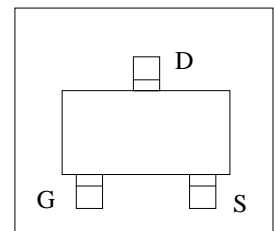
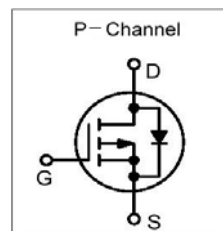
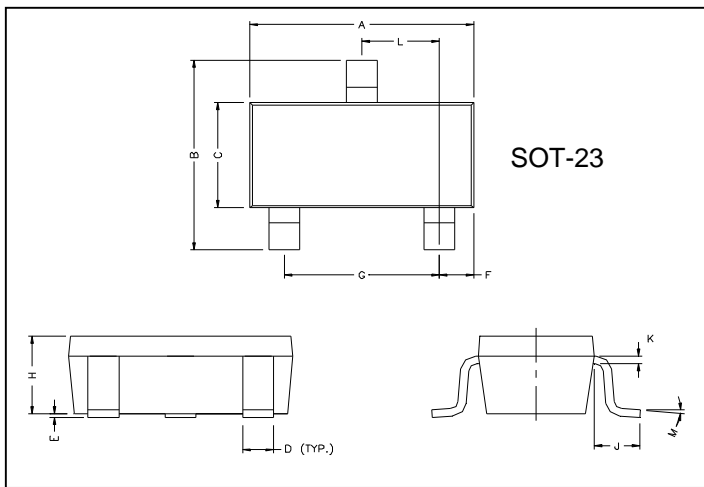

REF.	Millimeter		REF.	Millimete	
	Min.	Max.		Min.	Max.
A	2.80	3.00	G	1.80	2.00
B	2.30	2.50	H	0.90	1.1
C	1.20	1.40	K	0.10	0.20
D	0.30	0.50	J	0.35	0.70
E	0	0.10	L	0.92	0.98
F	0.45	0.55	M	0°	10°

Maximum Ratings and Thermal Characteristics (TA = 25oC unless otherwise noted)

Parameter	Symbol	Limit	Unit	
Drain-Source Voltage	V _{DS}	-20	V	
Gate-Source Voltage	V _{GS}	±12		
Continuous Drain Current	I _D	-4.1	A	
Pulsed Drain Current ¹⁾	I _{DM}	-15		
Maximum Power Dissipation ²⁾	P _D	TA = 25°	1.25	W
		TA = 75°C	0.8	
Operating Junction and Storage Temperature Range	T _J , T _{stg}	-55 to 150	°C	
Junction-to-Ambient Thermal Resistance (PCB mounted) ²⁾	R _{thJA}	100	°C/W	
Junction-to-Ambient Thermal Resistance (PCB mounted) ³⁾		166		

Notes

- 1) Pulse width limited by maximum junction temperature.
- 2) Surface Mounted on FR4 Board, t ≤ 5 sec.
- 3) Surface Mounted on FR4 Board.

-20V P-Channel Enhancement Mode MOSFET

ELECTRICAL CHARACTERISTICS

Parameter	Symbol	Test Condition	Min.	Typ.	Max.	Unit
Static						
Drain-Source Breakdown Voltage	BV_{DSS}	$V_{GS} = 0V, I_D = -250\mu A$	-20			V
Drain-Source On-State Resistance ¹⁾	$R_{DS(on)}$	$V_{GS} = -4.5V, I_D = -4.1A$		46	52	m Ω
		$V_{GS} = -2.5V, I_D = -3.0A$		60	75	
Gate Threshold Voltage	$V_{GS(th)}$	$V_{DS} = V_{GS}, I_D = -250\mu A$	0.4		1	V
Zero Gate Voltage Drain Current I_{D0}	I_{DSS}	$V_{DS} = -20V, V_{GS} = 0V$			-1	uA
		$V_{DS} = -20V, V_{GS} = 0V, T_J = 55^\circ C$			-10	
Gate Body Leakage	I_{GSS}	$V_{GS} = \pm 12V, V_{DS} = 0V$			± 100	nA
Forward Transconductance ¹⁾	g_{fs}	$V_{DS} = -5V, I_D = -3.5A$		6.5	—	S
Dynamic						
Total Gate Charge	Q_g	$V_{DS} = -6V, I_D \cong -3.5A$ $V_{GS} = -4.5V$		5.8		nC
Gate-Source Charge	Q_{gs}			0.85		
Gate-Drain Charge	Q_{gd}			1.7		
Turn-On Delay Time	$t_{d(on)}$	$V_{DD} = -6V, R_L = 6\Omega$ $I_D \cong -1A, V_{GEN} = -4.5V$ $R_G = 6\Omega$		13		ns
Turn-On Rise Time	t_r			36		
Turn-Off Delay Time	$t_{d(off)}$			42		
Turn-Off Fall Time	t_f			34		
Input Capacitance	C_{iss}	$V_{DS} = -6V, V_{GS} = 0V$ $f = 1.0 MHz$		415		pF
Output Capacitance	C_{oss}			223		
Reverse Transfer Capacitance	C_{rss}			87		
Source-Drain Diode						
Max. Diode Forward Current	I_S				-1.6	A
Diode Forward Voltage	V_{SD}	$I_S = -1.6A, V_{GS} = 0V$		-0.8	-1.2	V

¹⁾ Pulse test: pulse width $\leq 300\mu s$, duty cycle $\leq 2\%$

Typical Electrical and Thermal Characteristics

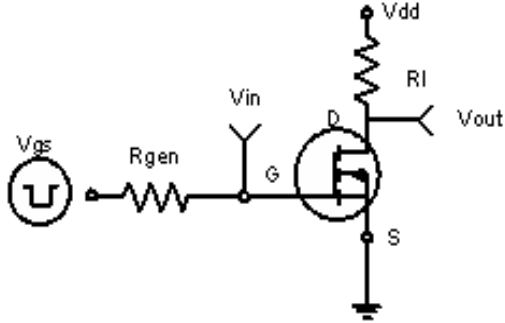

Figure 1: Switching Test Circuit

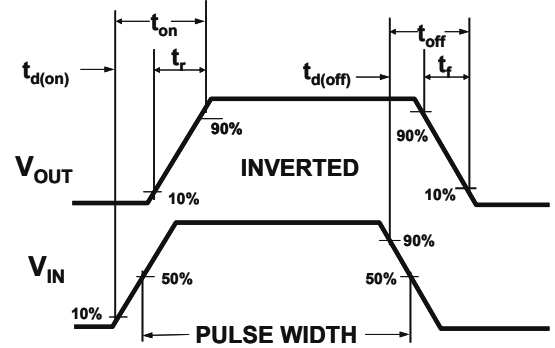

Figure 2: Switching Waveforms

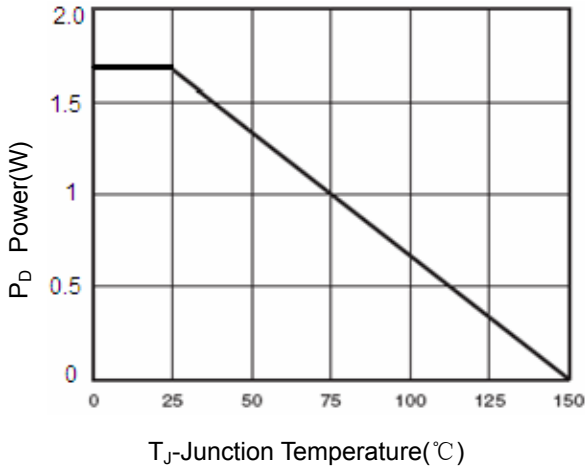

Figure 3 Power Dissipation

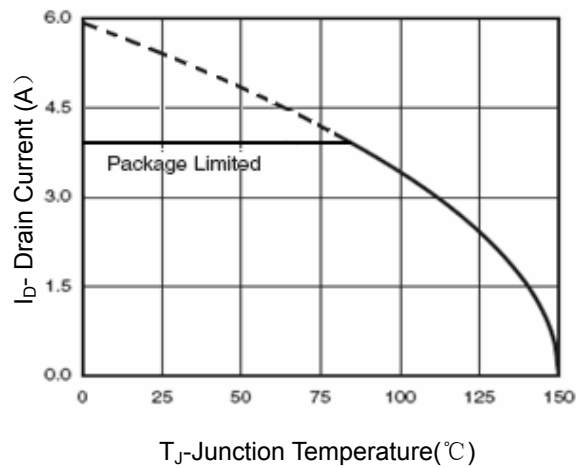

Figure 4 Drain Current

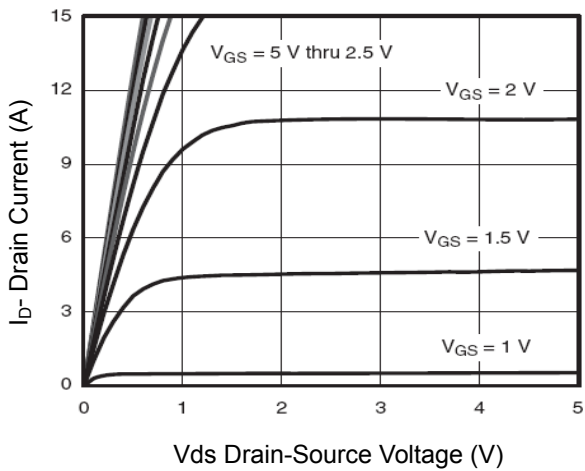

Figure 5 Output Characteristics

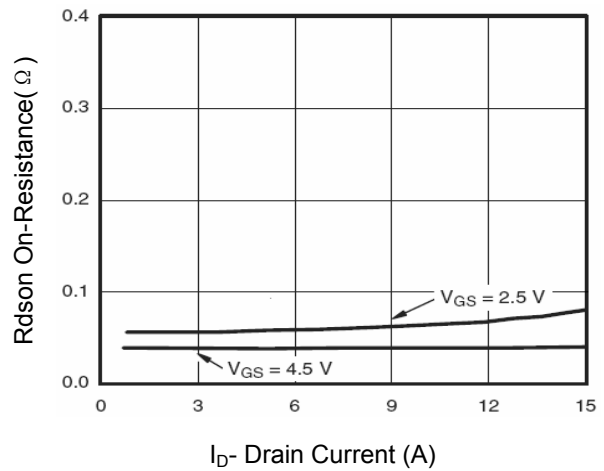
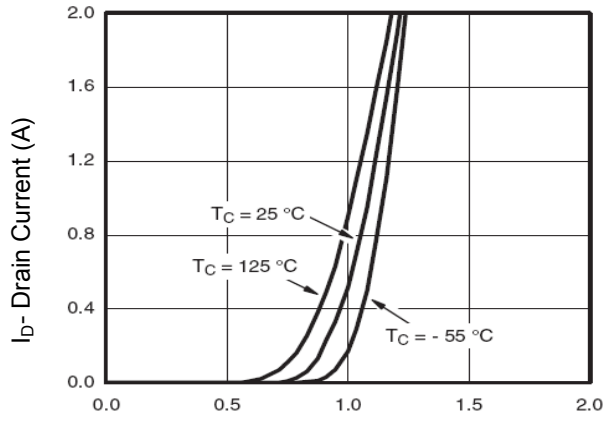
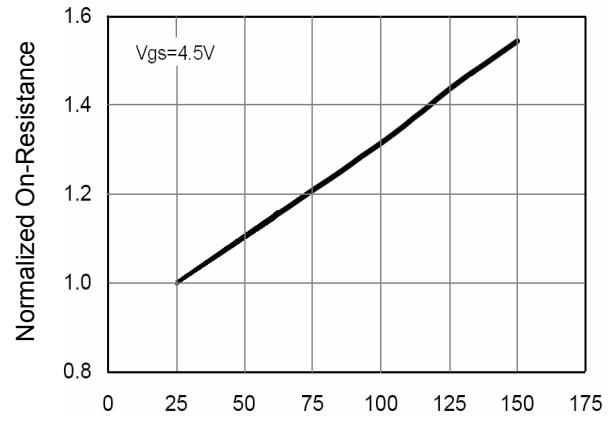

Figure 6 Drain-Source On-Resistance

-20V P-Channel Enhancement Mode MOSFET



Vgs Gate-Source Voltage (V)
Figure 7 Transfer Characteristics



Tj-Junction Temperature($^\circ\text{C}$)
Figure 8 Drain-Source On-Resistance

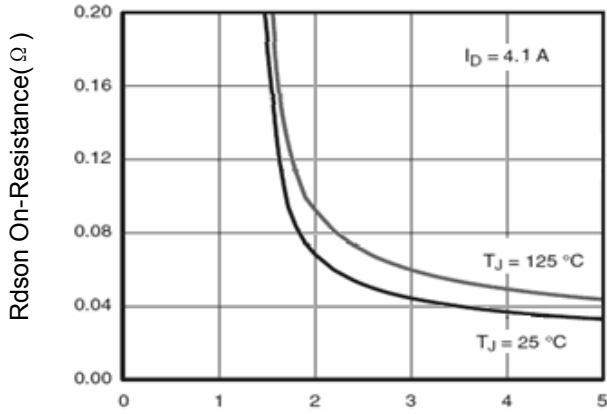

Vgs Gate-Source Voltage (V)
Figure 9 Rds(on) vs Vgs

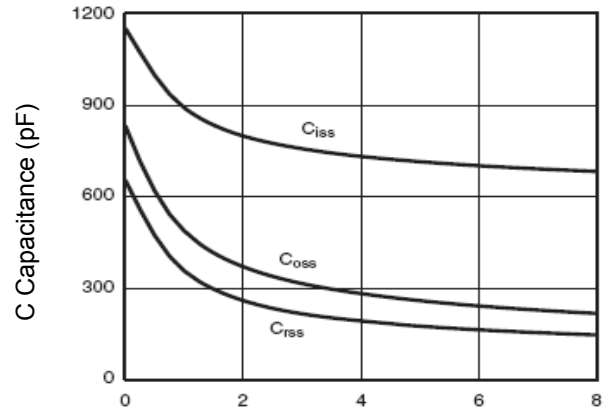

Vds Drain-Source Voltage (V)
Figure 10 Capacitance vs Vds

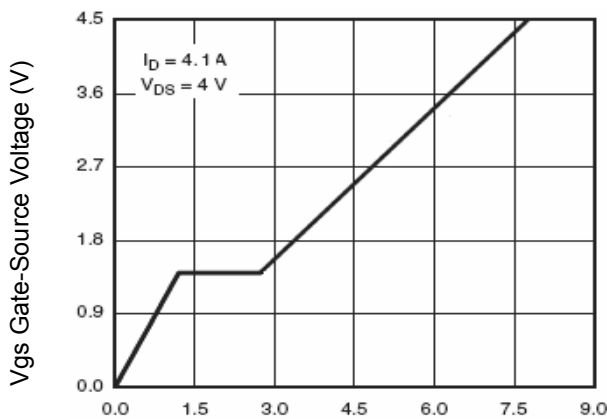

Qg Gate Charge (nC)
Figure 11 Gate Charge

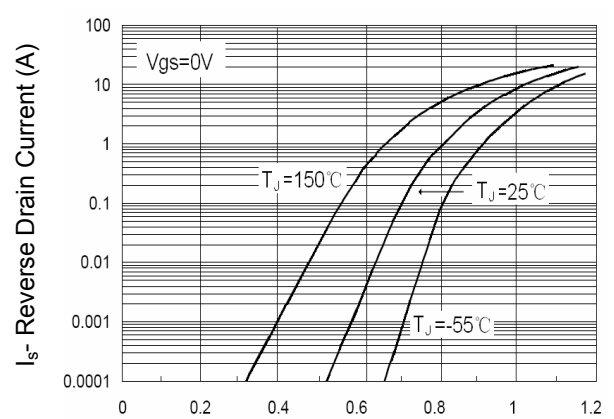

Vsd Source-Drain Voltage (V)
Figure 12 Source- Drain Diode Forward

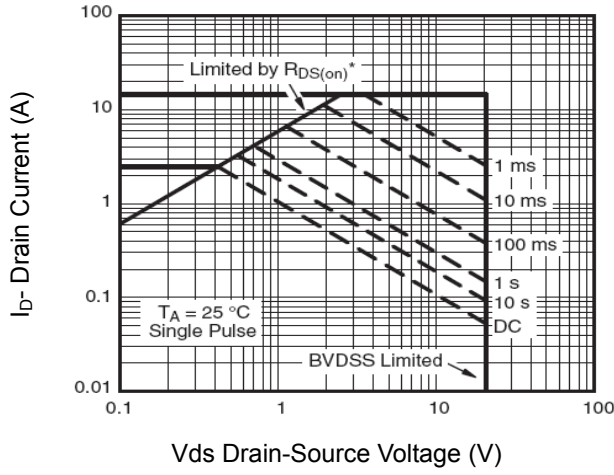

Figure 13 Safe Operation Area

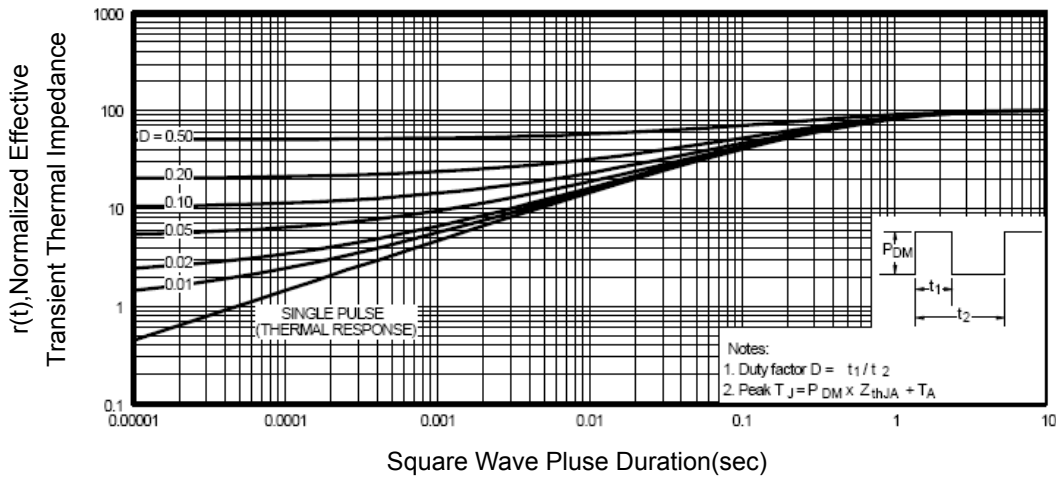

Figure 14 Normalized Maximum Transient Thermal Impedance

X-ON Electronics

Largest Supplier of Electrical and Electronic Components

Click to view similar products for [MOSFET](#) category:

Click to view products by [PUOLOP](#) manufacturer:

Other Similar products are found below :

[614233C](#) [648584F](#) [IRFD120](#) [IRFF430](#) [JANTX2N5237](#) [2N7000](#) [FCA20N60_F109](#) [FDZ595PZ](#) [AOD464](#) [2SK2267\(Q\)](#) [2SK2545\(Q,T\)](#)
[405094E](#) [423220D](#) [MIC4420CM-TR](#) [VN1206L](#) [614234A](#) [715780A](#) [SSM6J414TU,LF\(T](#) [751625C](#) [PSMN4R2-30MLD](#)
[TK31J60W5,S1VQ\(O](#) [2SK2614\(TE16L1,Q\)](#) [DMN1017UCP3-7](#) [EFC2J004NUZTDG](#) [FCAB21350L1](#) [P85W28HP2F-7071](#) [DMN1053UCP4-7](#)
[NTE2384](#) [NTE2969](#) [NTE6400A](#) [DMN2080UCB4-7](#) [DMN61D9UWQ-13](#) [US6M2GTR](#) [DMN31D5UDJ-7](#) [SSM6P54TU,LF](#) [DMP22D4UFO-](#)
[7B](#) [IPS60R3K4CEAKMA1](#) [DMN1006UCA6-7](#) [DMN16M9UCA6-7](#) [STF5N65M6](#) [STU5N65M6](#) [C3M0021120D](#) [DMN13M9UCA6-7](#)
[BSS340NWH6327XTSA1](#) [MCM3400A-TP](#) [DMTH10H4M6SPS-13](#) [IRF40SC240ARMA1](#) [IPS60R1K0PFD7SAKMA1](#)
[IPS60R360PFD7SAKMA1](#) [IPS60R600PFD7SAKMA1](#)