

Features

- 80V/100A
RDS(ON)=6.5mΩ (typ.)@ VGS=10V
- Lead free and Green Device Available
- Low Rds-on to Minimize Conductive Loss
- High avalanche Current
- 100% Avalanche Tested

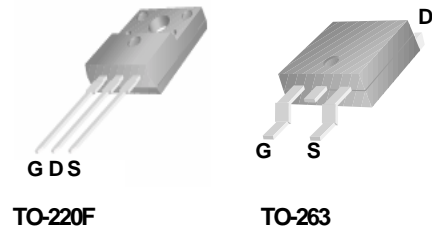
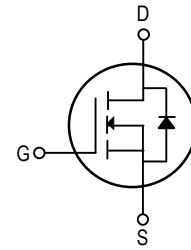

Application

- Power Supply
- DC-DC Converters
- UPS
- Battery Manageme

Absolute Maximum Ratings (T_A=25°C unless otherwise noted)

Symbol	Parameter	Maximum	Unit
V _{DSS}	Drain-to-Source Voltag	80	V
V _{GSS}	Gate-to-Source	±25	V
I _D ³	Continuous Drain Current	T _C =25°C	100
		T _C =100°C	70
I _{DM} ⁴	Pulsed Drain Current	400	A
EAS ⁵	Avalanche energy	313	mJ
PD	Maximum Power Dissipation	T _C =25°C	200
T _J , T _{STG}	Junction & Storage Temperature Range		-55~175
			°C

Thermal Characteristics

Symbol	Parameter	Typical	Unit
Rθjc	Thermal Resistance-Junction to Case	0.63	°C/W
Rθja	Thermal Resistance-Junction to Ambient	62.5	

Electrical Characteristics (TA=25°C unless otherwise noted)

Symbol	Parameter	Test Conditions	Min.	Typ	Max.	Unit
Static Characteristics						
BV_{DSS}	Drain-Source Breakdown Voltage	$V_{GS}=0V, I_D=250\mu A$	80	—	—	V
I_{DSS}	Zero Gate Voltage Drain Current	$V_{DS}=80V, V_{GS}=0V$	—	—	1	μA
$V_{GS(th)}$	Gate Threshold Voltage	$V_{DS}=V_{GS}, I_D=250\mu A$	2	3	4	V
I_{GSS}	Gate Leakage Current	$V_{GS}=\pm 25V, V_{DS}=0V$	—	—	± 100	nA
$R_{DS(on)}^1$	Drain-Source On-Resistance	$V_{GS}=10V, I_D=50A$	—	6.5	8.5	m Ω
			—	—	—	
Diode Characteristics						
V_{SD}^1	Diode Forward Voltage	$I_{SD}=50A, V_{GS}=0V$	—	0.9	1.3	V
I_S^3	Diode Continuous Forward Current		—	—	97	A
t_{rr}	Reverse Recovery Time	$I_S=50A,$	—	45	—	nS
Q_{rr}	Reverse Recovery Charge	$di/dt=100A/\mu s$	—	65	—	nC
Dynamic Characteristics²						
C_{iss}	Input Capacitance	$V_{GS}=0V, V_{DS}=50V$ Frequency=1MHz	—	3175	—	pF
C_{oss}	Output Capacitance		—	440	—	
C_{riss}	Reverse Transfer Capacitance		—	268	—	
$t_{d(on)}$	Turn-On Delay Time	$V_{DS}=40V, I_D=50A,$ $V_{GS}=10V, (Note 1, 4)$	—	49	—	nS
t_r	Rise Time		—	64	—	
$t_{d(off)}$	Turn-Off Delay Time		—	139	—	
t_f	Fall Time		—	48	—	
Gate Charge Characteristics²						
Q_g	Total Gate Charge	$V_{DS}=64V, I_D=50A,$ $V_{GS}=10V, (Note 1, 4)$	—	76	—	nC
Q_{gs}	Gate-to-Source Charge		—	21	—	
Q_{gd}	Gate-to-Drain Charge		—	24	—	

Note: 1: Pulse test; pulse width $\leq 300\mu s$, duty cycle $\leq 2\%$.

2: Guaranteed by design, not subject to production testing.

3: Package limitation current is 100A. Calculated continuous current based on maximum allowable junction temperature.

4: Repetitive rating, pulse width limited by max junction temperature.

5: Starting $T_J = 25^\circ C, L = 1mH, I_{AS} = 25A$.

Typical Characteristics

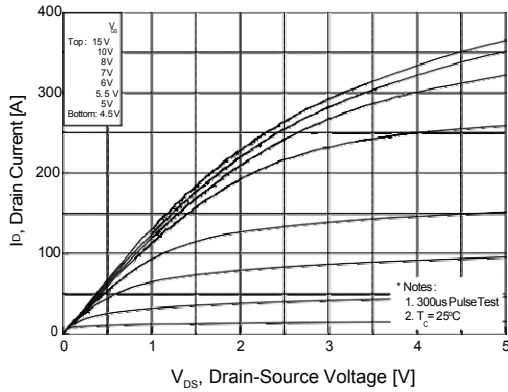

Figure 1. On Region Characteristics

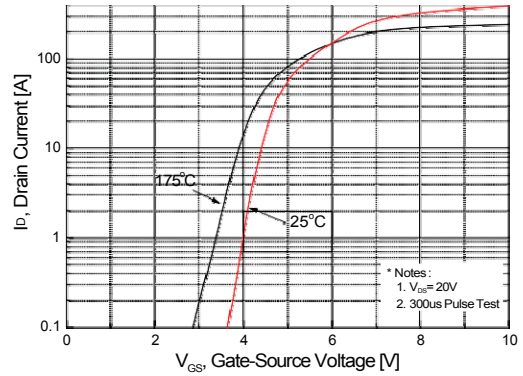

Figure 2. Transfer Characteristics

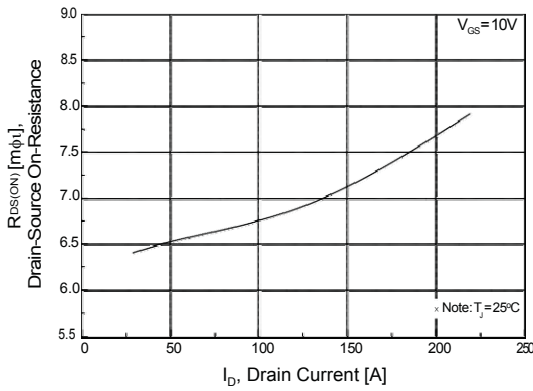

Figure 3. On Resistance Variation with Drain Current and Gate Voltage

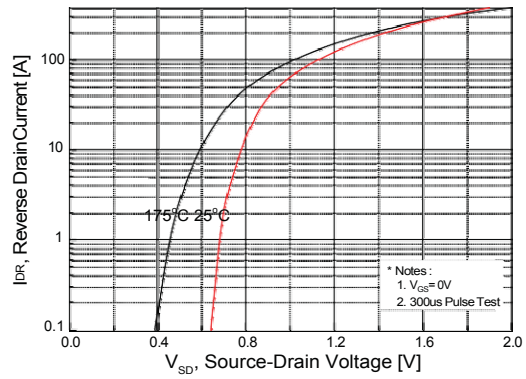

Figure 4. Body Diode Forward Voltage Variation with Source Current and Temperature

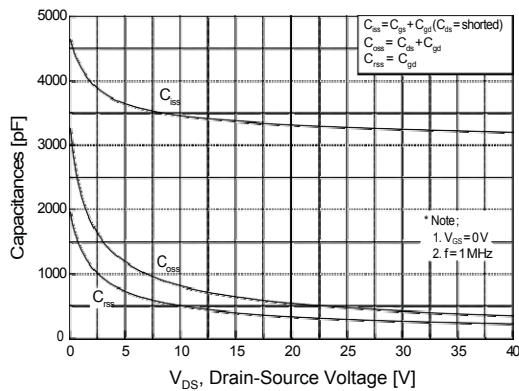

Figure 5. Capacitance Characteristics

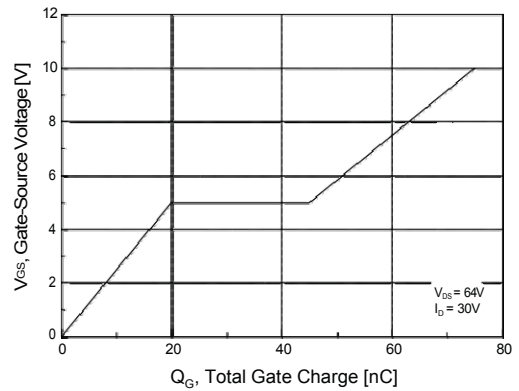

Figure 6. Gate Charge Characteristics

Typical Characteristics (continued)

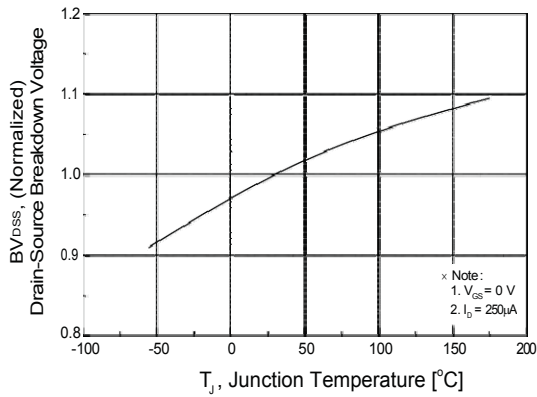

Figure 7. Breakdown Voltage Variation vs Temperature

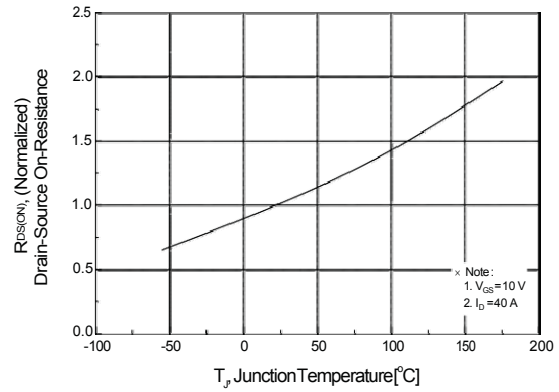

Figure 8. On-Resistance Variation vs Temperature

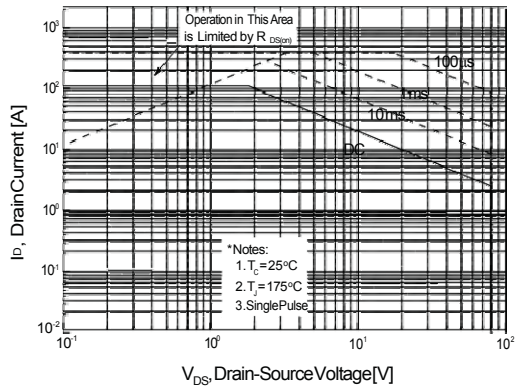

Figure 9. Maximum Safe Operating Area

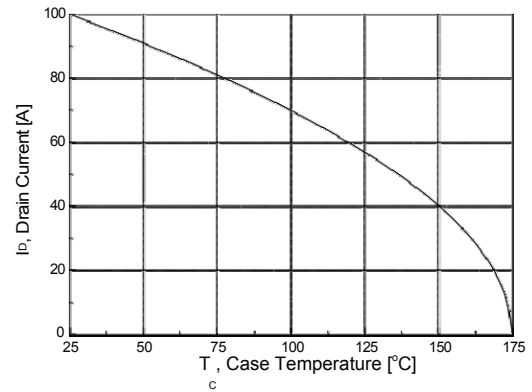

Figure 10. Maximum Drain Current vs Case Temperature

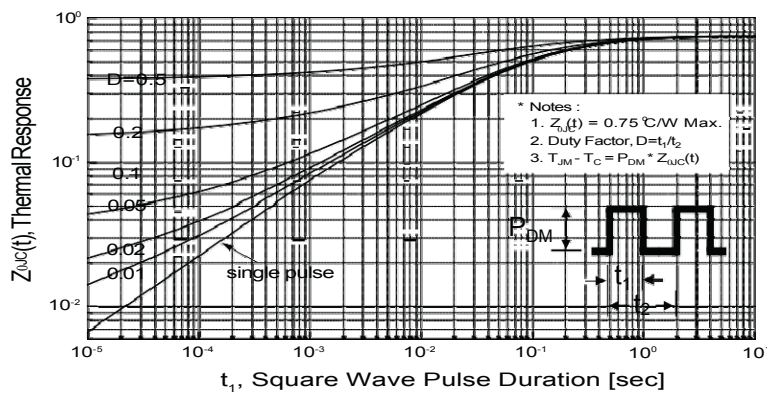
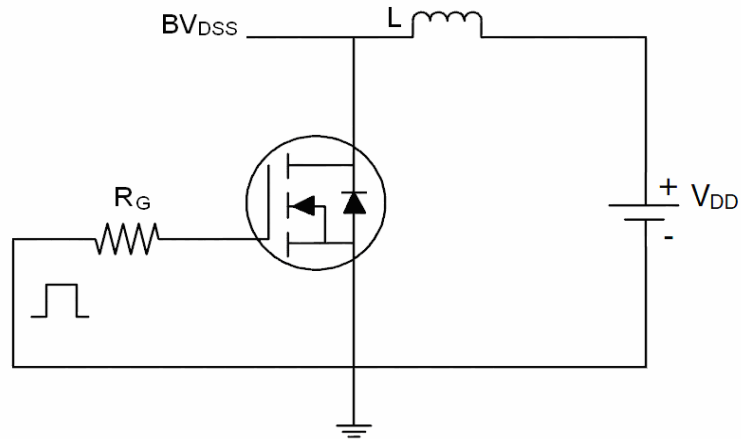

Figure 11. Transient Thermal Response Curve

Test Circuit

1) E_{AS} test Circuit



2) Gate charge test Circuit

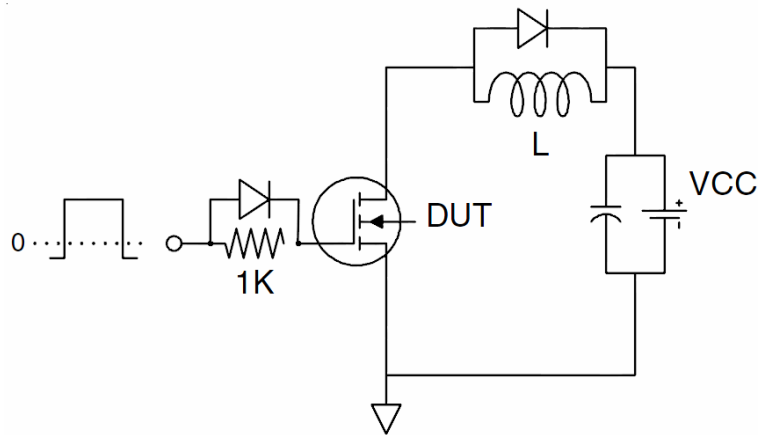

3) Switch Time Test Circuit

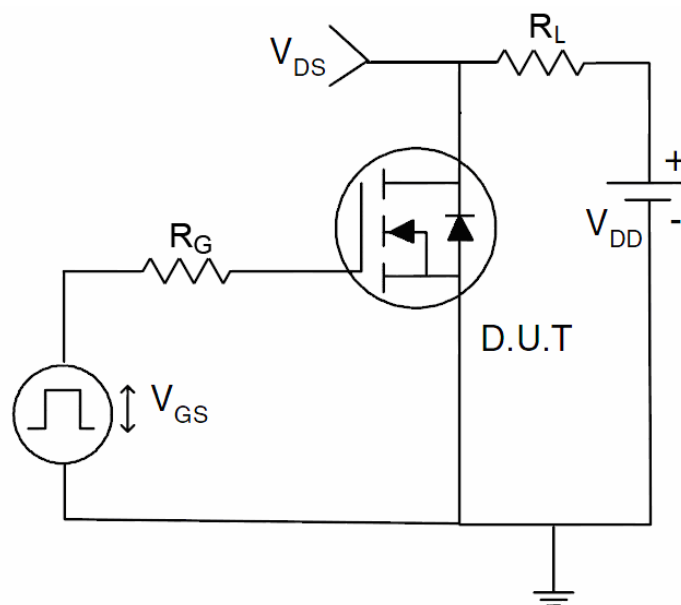

X-ON Electronics

Largest Supplier of Electrical and Electronic Components

Click to view similar products for [MOSFET](#) category:

Click to view products by [PUOLOP](#) manufacturer:

Other Similar products are found below :

[614233C](#) [648584F](#) [IRFD120](#) [IRFF430](#) [JANTX2N5237](#) [2N7000](#) [FCA20N60_F109](#) [FDZ595PZ](#) [AOD464](#) [2SK2267\(Q\)](#) [2SK2545\(Q,T\)](#)
[405094E](#) [423220D](#) [MIC4420CM-TR](#) [VN1206L](#) [614234A](#) [715780A](#) [SSM6J414TU,LF\(T](#) [751625C](#) [BSC884N03MS G](#) [BSF024N03LT3 G](#)
[PSMN4R2-30MLD](#) [TK31J60W5,S1VQ\(O](#) [2SK2614\(TE16L1,Q\)](#) [DMN1017UCP3-7](#) [EFC2J004NUZTDG](#) [FCAB21350L1](#) [P85W28HP2F-](#)
[7071](#) [DMN1053UCP4-7](#) [NTE2384](#) [NTE2969](#) [NTE6400A](#) [DMN2080UCB4-7](#) [DMN61D9UWQ-13](#) [US6M2GTR](#) [DMN31D5UDJ-7](#)
[SSM6P54TU,LF](#) [DMP22D4UFO-7B](#) [IPS60R3K4CEAKMA1](#) [DMN1006UCA6-7](#) [DMN16M9UCA6-7](#) [STF5N65M6](#) [STU5N65M6](#)
[C3M0021120D](#) [DMN13M9UCA6-7](#) [BSS340NWH6327XTSA1](#) [MCM3400A-TP](#) [DMTH10H4M6SPS-13](#) [IRF40SC240ARMA1](#)
[IPS60R1K0PFD7SAKMA1](#)