

Features

- 60V/120A
 $R_{DS(ON)}=4.2m\Omega(\text{typ.})@ V_{GS}=10V$
- Lead free and Green Device Available
- Low Rds-on to Minimize Conductive Loss
- High avalanche Current
- 100% Avalanche Tested

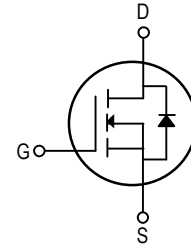

Application

- Power Supply
- DC-DC Converters
- UPS
- Battery Management System

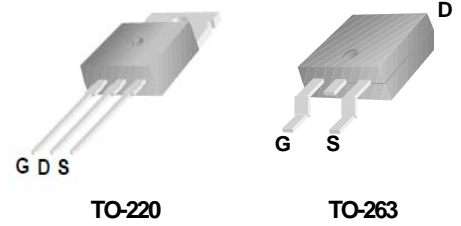

Absolute Maximum Ratings ($T_A=25^\circ\text{C}$ unless otherwise noted)

Symbol	Parameter	Maximum	Unit
V_{DSS}	Drain-to-Source Voltage	60	V
V_{GSS}	Gate-to-Source Voltage	± 25	V
I_D^3	Continuous Drain Current	$T_C=25^\circ\text{C}$	120
		$T_C=100^\circ\text{C}$	80
I_{DP}^4	Pulsed Drain Current	$T_C=25^\circ\text{C}$	480
EAS^5	Avalanche energy	684	mJ
PD	Maximum Power Dissipation	$T_C=25^\circ\text{C}$	188
T_J, T_{STG}	Junction & Storage Temperature Range	-55~175	$^\circ\text{C}$

Thermal Characteristics

Symbol	Parameter	Typical	Unit
$R_{\theta jc}$	Thermal Resistance-Junction to Case	0.67	$^\circ\text{C}/\text{W}$
$R_{\theta ja}$	Thermal Resistance-Junction to Ambient	62.5	

Electrical Characteristics (TA=25°C unless otherwise noted)

Symbol	Parameter	Test Conditions	Min.	Typ	Max.	Unit
Static Characteristics						
BV_{DSS}	Drain-Source Breakdown Voltage	$V_{GS}=0V, I_D=250\mu A$	60	—	—	V
I_{DSS}	Zero Gate Voltage Drain Current	$V_{DS}=60V, V_{GS}=0V$	—	—	1	μA
$V_{GS(th)}$	Gate Threshold Voltage	$V_{DS}=V_{GS}, I_D=250\mu A$	2	3	4	V
I_{GSS}	Gate Leakage Current	$V_{GS}=\pm 25V, V_{DS}=0V$	—	—	± 100	nA
$R_{DS(on)}^1$	Drain-Source On-Resistance	$V_{GS}=10V, I_D=60A$	—	4.2	5.6	m Ω
			—	—	—	
Diode Characteristics						
V_{SD}^1	Diode Forward Voltage	$I_{SD}=60A, V_{GS}=0V$	—	0.8	1.3	V
I_S^3	Diode Continuous Forward Current		—	—	60	A
t_{rr}	Reverse Recovery Time	$I_F=60A, dI/dt=100A/\mu s$	—	32	—	nS
Q_{rr}	Reverse Recovery Charge	s	—	60	—	nC
Dynamic Characteristics²						
C_{iss}	Input Capacitance	$V_{GS}=0V, V_{DS}30 V$ Frequency=1MHz	—	3130	—	pF
C_{oss}	Output Capacitance		—	521	—	
C_{riss}	Reverse Transfer Capacitance		—	304	—	
$t_{d(on)}$	Turn-On Delay Time	$V_{DD}=30V, I_D=60A,$ $V_{GS}=10V, R_G=5\Omega$	—	21	—	nS
t_r	Rise Time		—	56	—	
$t_{d(off)}$	Turn-Off Delay Time		—	53	—	
t_f	Fall Time		—	27	—	
Gate Charge Characteristics²						
Q_g	Total Gate Charge	$V_{DS}=48V, V_{GS}=10V$ $I_D=60A$	—	76	—	nC
Q_{gs}	Gate-to-Source Charge		—	18	—	
Q_{gd}	Gate-to-Drain Charge		—	31	—	

Note: 1: Pulse test; pulse width $\leq 300\mu s$, duty cycle $\leq 2\%$.

2: Guaranteed by design, not subject to production testing.

3: Package limitation current is 60A. Calculated continuous current based on maximum allowable junction temperature.

4: Repetitive rating, pulse width limited by max junction temperature.

5: Starting $T_J = 25^\circ C, L = 0.5mH, I_{AS} = 37A$.

Typical Characteristics

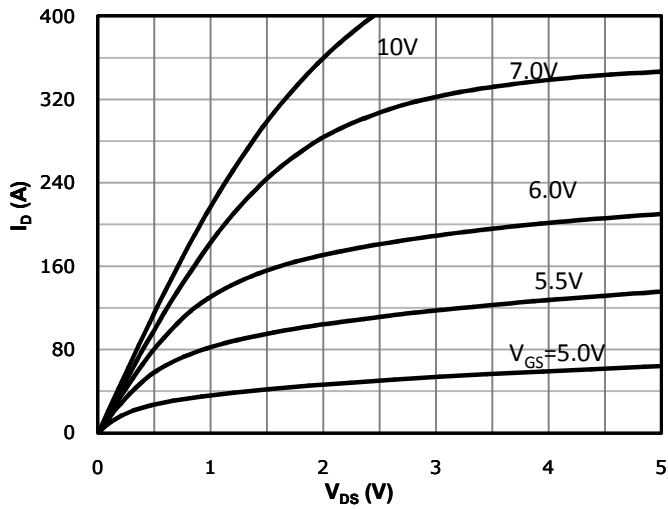

Fig 1: Output Characteristics

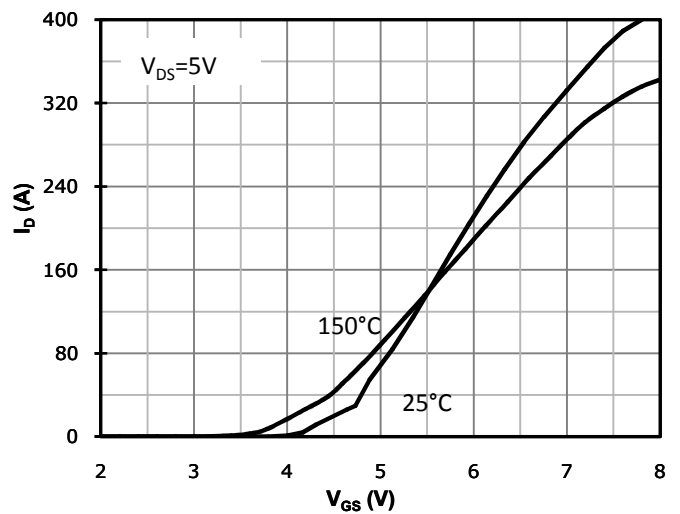

Fig 2: Transfer Characteristics

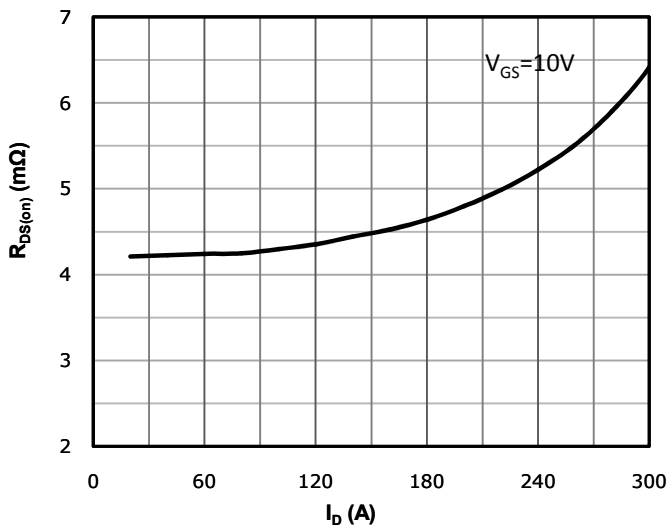

Fig 3: Rds(on) vs Drain Current and Gate Voltage

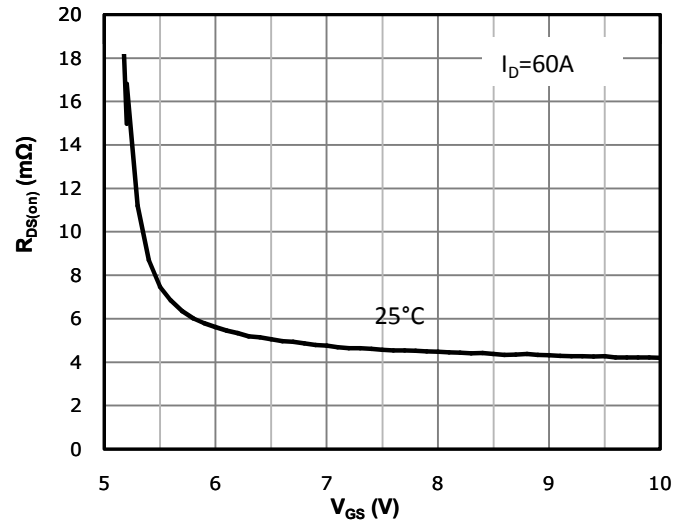

Fig 4: Rds(on) vs Gate Voltage

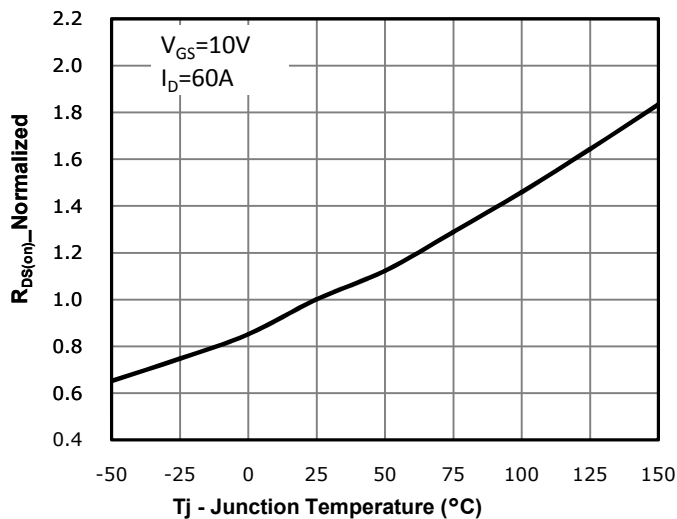

Fig 5: Rds(on) vs. Temperature

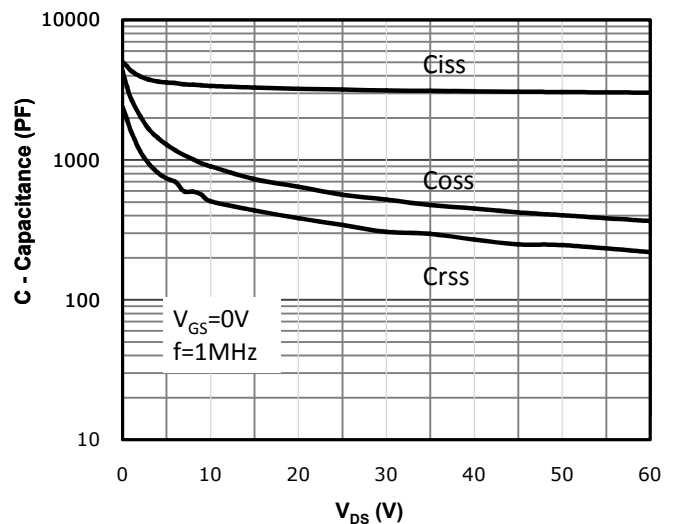

Fig 6: Capacitance Characteristics

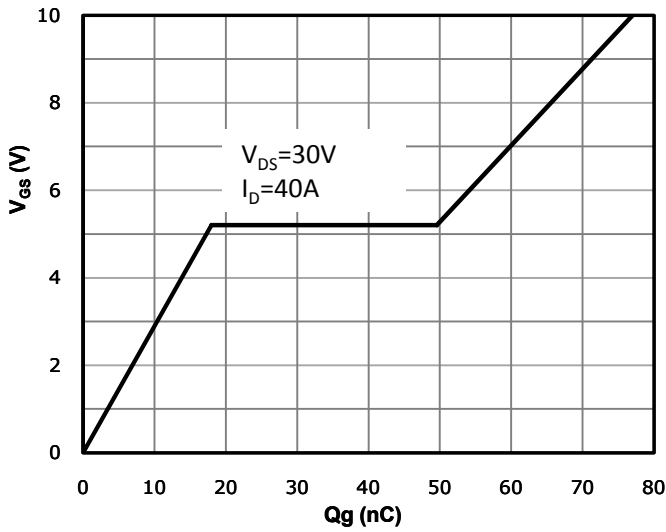

Fig 7: Gate Charge Characteristics

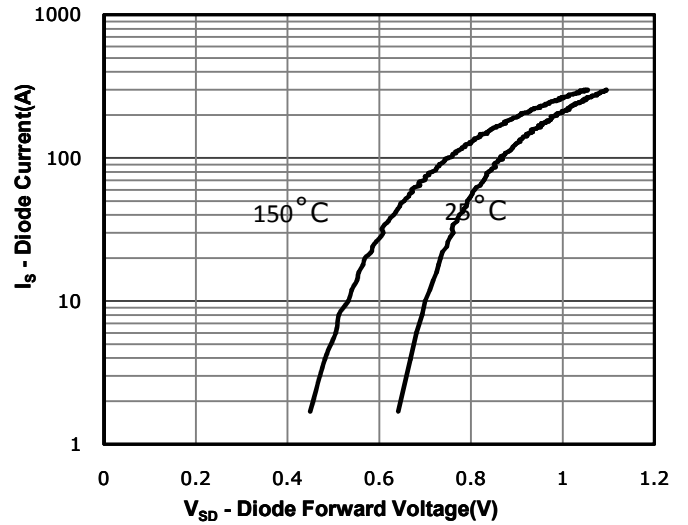

Fig 8: Body-diode Forward Characteristics

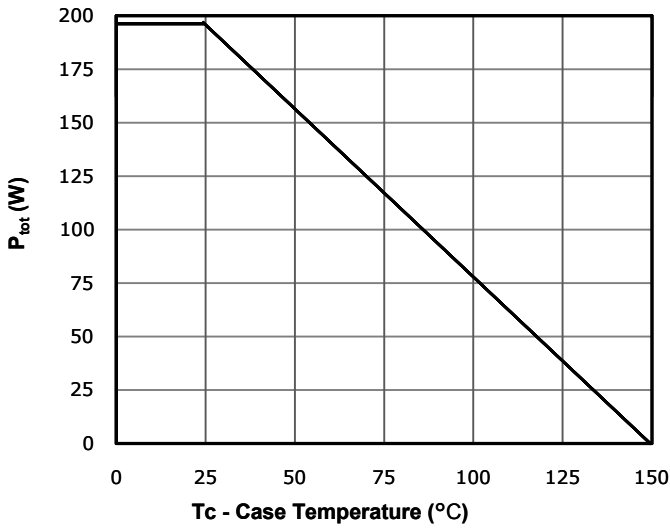

Fig 9: Power Dissipation

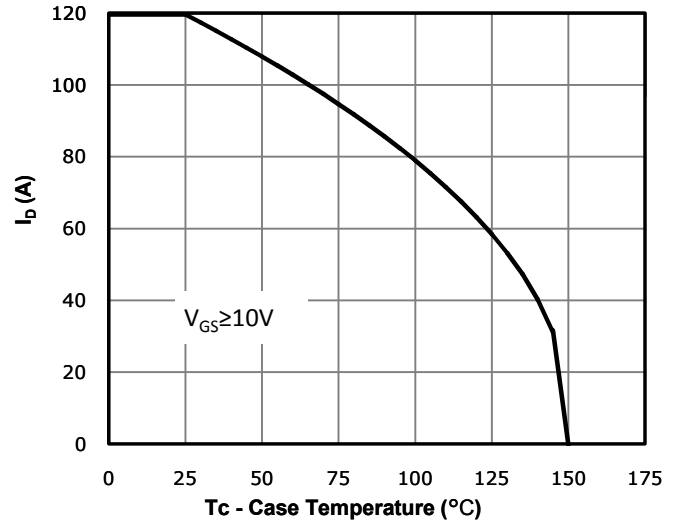

Fig 10: Drain Current Derating

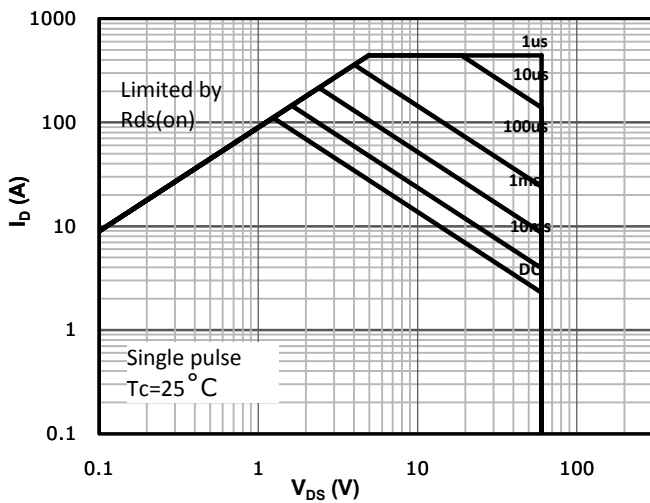
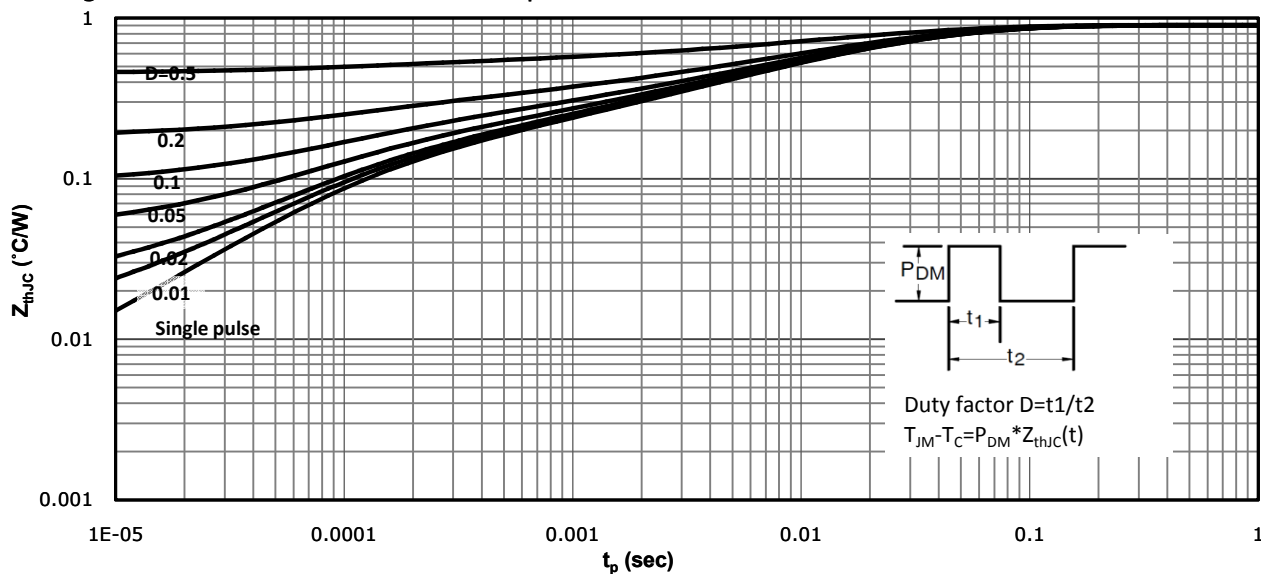

Fig 11: Safe Operating Area

Fig 12: Max. Transient Thermal Impedance



Test Circuit

1) E_{AS} test Circuit

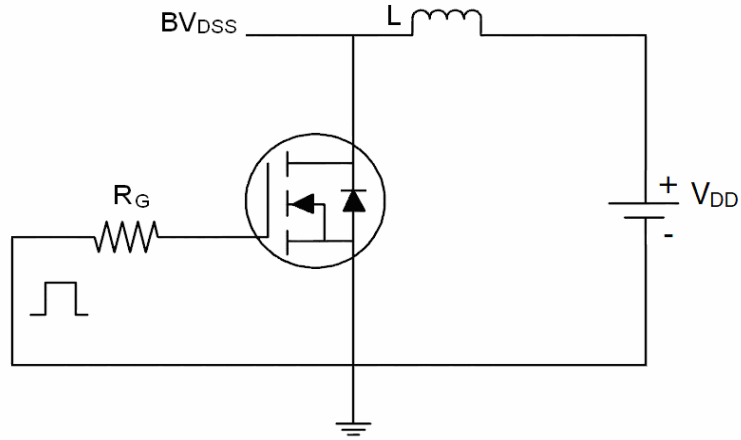

2) Gate charge test Circuit

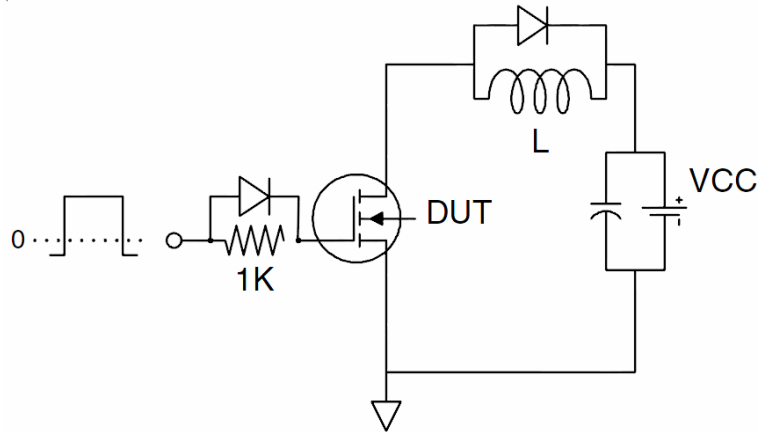

3) Switch Time Test Circuit

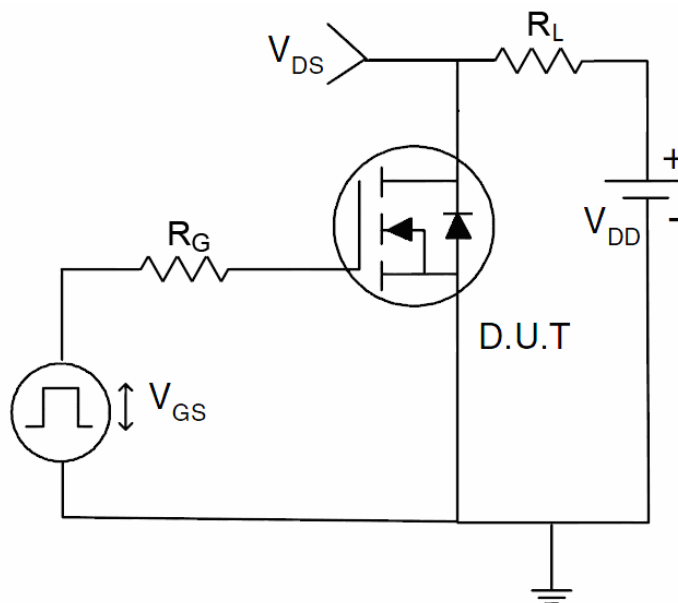

X-ON Electronics

Largest Supplier of Electrical and Electronic Components

Click to view similar products for [MOSFET](#) category:

Click to view products by [PUOLOP](#) manufacturer:

Other Similar products are found below :

[614233C](#) [648584F](#) [NTNS3A92PZT5G](#) [IRFD120](#) [IRFF430](#) [JANTX2N5237](#) [2N7000](#) [2SK2464-TL-E](#) [FCA20N60_F109](#) [FDZ595PZ](#) [AOD464](#)
[2SK2267\(Q\)](#) [2SK2545\(Q,T\)](#) [405094E](#) [423220D](#) [MIC4420CM-TR](#) [VN1206L](#) [614234A](#) [715780A](#) [SSM6J414TU,LF\(T](#) [751625C](#)
[IPP60R600P6XKSA1](#) [RJK60S5DPK-M0#T0](#) [PSMN4R2-30MLD](#) [TK31J60W5,S1VQ\(O](#) [2SK2614\(Te16L1,Q\)](#) [DMN1017UCP3-7](#)
[EFC2J004NUZTDG](#) [FCAB21350L1](#) [P85W28HP2F-7071](#) [DMN1053UCP4-7](#) [NTE2384](#) [NTE2969](#) [NTE6400A](#) [DMN61D9UWQ-13](#)
[US6M2GTR](#) [DMN31D5UDJ-7](#) [SSM6P54TU,LF](#) [DMP22D4UFO-7B](#) [IPS60R3K4CEAKMA1](#) [DMN1006UCA6-7](#) [DMN16M9UCA6-7](#)
[STF5N65M6](#) [STU5N65M6](#) [C3M0021120D](#) [DMN13M9UCA6-7](#) [BSS340NWH6327XTSA1](#) [MCM3400A-TP](#) [DMTH10H4M6SPS-13](#)
[IRF40SC240ARMA1](#)