

# 规格承认书

## SPECIFICATION

编号(No): .....

日期(Date): .....

客户 (Customer): .....

品名(Product Name): 片式NTC热敏电阻 Chip NTC thermistor

恭成料号 (QAMCN Part Number) : QN0402X103J3435HA

客户规格(Customer's Part Number): .....

客户承认 CUSTOMER CONFIRM			
承认章 STAMP	核准 APPROVE	审核 CHECK	经办人 SIGNATURE

### 恭成科技有限公司

## Quest for Advanced Materials Electronics Co., Ltd.

营销中心: 广东省深圳市龙华新区观澜银星科技大厦 518109

Marketing Center: Yinxing Technology Building, Guanlan, Longhua new district, Shenzhen 518109

电话 Tel: 0086-755-23732935 传真 Fax: 0086-755-23762516

制造中心: 河北省唐山市曹妃甸工业区中日生态园 063200

Manufactory: Sino-Japan Eco-industrial park, Caofeidian industrial district, Tangshan, Hebei, China 063200

电话 Tel: 0086-315-7332530

网址 Website: <https://www.qamcn.com>

邮箱 E-Mail: [qam@qamcn.com](mailto:qam@qamcn.com)

**1 外形尺寸 Shape and Dimensions**

- 尺寸：见图 1 和表 1
- PCB 焊盘：见图 2 和表 1
- Dimensions: See Fig.1 and Table 1.
- Recommended PCB pattern for reflow soldering: See Fig.2 and Table 1



图 1 Fig.1



图 2 Fig.2

表 1 (Table 1)

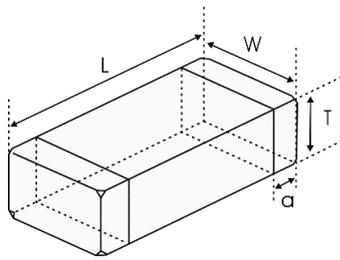
单位 unit: inch[mm]

类别 Type	L	W	T	a	A	B	C
0402 [1005]	0.039±0.006 [1.0±0.15]	0.020±0.006 [0.5±0.15]	0.020±0.006 [0.5±0.15]	0.010±0.004 [0.25±0.1]	[0.45-0.55]	[0.4-0.5]	[0.45-0.55]

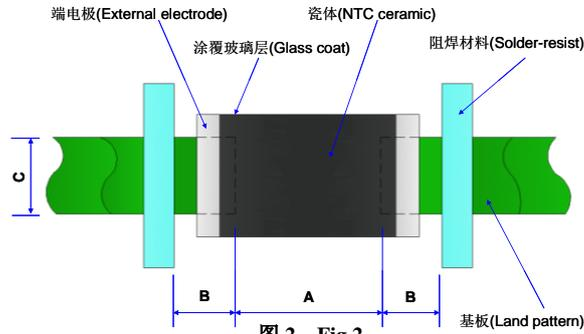
**2 产品标识 (料号) Product Identification(Part Number)**

QN   0402   X   103   J   3435   H   A  
 ①   ②   ③   ④   ⑤   ⑥   ⑦   ⑧

① 类别 Type	
QN	片式 NTC 热敏电阻器 Chip NTC Thermistor
② 外形尺寸(mm) External Dimensions (L×W×T)	
0201[0603]	0.60×0.30×0.30
0402[1005]	1.00×0.50×0.50
0603[1608]	1.60×0.80×0.80
0805[2012]	2.00×1.25×0.85
1206[3216]	3.20×1.60×0.85
③ 分隔符 Delimiter	
	X

④ 25℃的零功率电阻 Nominal Zero-Power Resistance	
222	2.2kΩ
103	10kΩ
474	470kΩ

⑤ 电阻值公差 Tolerance of Resistance	
F	±1%
G	±2%
H	±3%
J	±5%

⑥ B 值常数 B Constant	
3435	3435K
3950	3950K
4250	4250K

⑦ B 值公差 Tolerance of B Constant	
F	±1%
H	±3%

⑧ B 值计算方式 B constant calculation method	
A	25℃&85℃
B	25℃&50℃

**3 电气特性 Electrical Characteristics**

型号 Part No	电阻值 Resistance (25℃) (kΩ)	B 常数 B Constant (25/50℃) (K)	B 常数 B Constant (25/85℃) (K)	允许工作电流 Permissible Operating Current (25℃) (mA)	耗散系数 Dissipation Factor (mW/℃)	热时间常数 Thermal Time Constant (s)	额定功率 Rated Electric Power(25℃) (mW)	工作温度 Operating ambient temperature (℃)
QN0402X103J3435HA	10±5%	3380	3435±3%	0.31	1.0	<3	100	-40~+125

**4 检验和测试程序**

▪ **测试条件**

如无特别规定，检验和测试的标准大气环境条件如下：

- a. 环境温度：20±15℃；
- b. 相对湿度：65±20%；
- c. 气压：86 kPa~106 kPa

如果对测试结果有异议，则在下述条件下测试：

- a. 环境温度：25±2℃；
- b. 相对湿度：65±5%
- c. 气压：86kPa ~ 106kPa

▪ **检查设备**

外观检查：20 倍放大镜；  
阻值检查：热敏电阻测试仪

**4 Test and Measurement Procedures**

▪ **Test Conditions**

Unless otherwise specified, the standard atmospheric conditions for measurement/test as:

- a. Ambient Temperature: 20±15℃
- b. Relative Humidity: 65±20%
- c. Air Pressure: 86kPa to 106kPa

If any doubt on the results, measurements/tests should be made within the following limits:

- a. Ambient Temperature: 25±2℃
- b. Relative Humidity: 65±5%
- c. Air Pressure: 86kPa to 106kPa

▪ **Inspection Equipment**

Visual Examination: 20× magnifier  
Resistance value test: Thermistor resistance tester

**5 电性测试 Electrical Test**

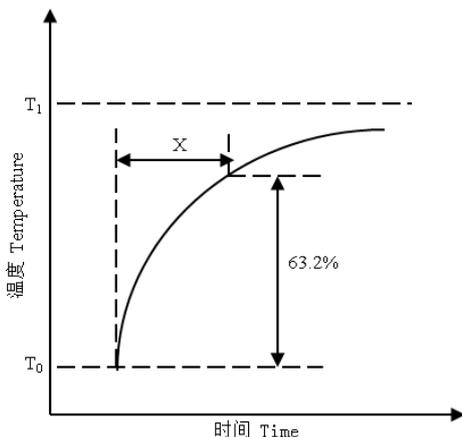
序号 No.	项目 Items	测试方法及备注 Test Methods and Remarks
1	25℃零功率电阻值 Nominal Zero-Power Resistance at 25℃(R25)	环境温度 Ambient temperature: 25±0.05℃ 测试功率 Measuring electric power: ≤0.1mW
2	B 值常数 Nominal B Constant	分别在环境温度 25±0.05℃, 50±0.05℃或 85±0.05℃下测量电阻值。 Measure the resistance at the ambient temperature of 25±0.05℃, 50±0.05℃ or 85±0.05℃. $B(25-50^{\circ}\text{C}) = \frac{\ln R_{25} - \ln R_{50}}{1/T_{25} - 1/T_{50}} \quad B(25-85^{\circ}\text{C}) = \frac{\ln R_{25} - \ln R_{85}}{1/T_{25} - 1/T_{85}}$ T: 绝对温度 (K) Absolute temperature (K)
3	热时间常数 Thermal Time Constant	在零功率条件下，当热敏电阻的环境温度发生急剧变化时，热敏电阻元件产生最初温度 T0 与最终温度 T1 两者温度差的 63.2%的温度变化所需要的时间，通常以秒(S)表示。 The total time for the temperature of the thermistor to change by 63.2% of the difference from ambient temperature T <sub>0</sub> (°C) to T <sub>1</sub> (°C) by the drastic change of the power applied to thermistor from Non-zero Power to Zero-Power state, normally expressed in second(S). 

4	耗散系数 Dissipation Factor	在一定环境温度下，NTC 热敏电阻通过自身发热使其温度升高 1℃ 时所需要的功率，通常以 mW/℃ 表示。可由下面公式计算： The required power which makes the NTC thermistor body temperature raise 1℃ through self-heated, normally expressed in milliwatts per degree Celsius (mW/℃). It can be calculated by the following formula: $\delta = \frac{W}{T-T_0}$
5	额定功率 Rated Power	在环境温度 25℃ 下因自身发热使表面温度升高 100℃ 所需要的功率。 The necessary electric power makes thermistor's temperature rise 100℃ by self-heating at ambient temperature 25℃.
6	允许工作电流 Permissible operating current	在静止空气中通过自身发热使其升温为 1℃ 的电流。 The current that keep body temperature of chip NTC on the PC board in still air rising 1℃ by self-heating.

**6 信赖性试验 Reliability Test**

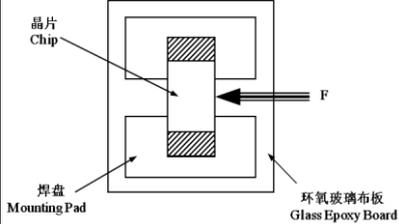
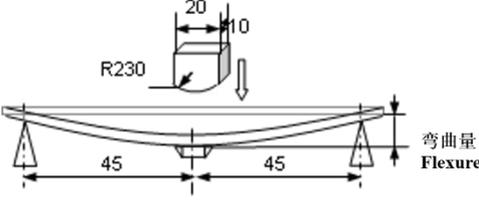
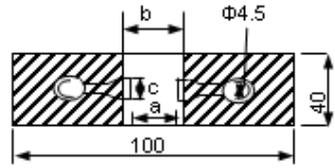
项目 Items	测试标准 Standard	测试方法及备注 Test Methods and Remarks	要求 Requirements																														
端头附着力 Terminal Strength	IEC 60068-2-21	<p>将晶片焊接在测试基板上（如右图所示的环氧玻璃布板），按箭头所示方向施加作用力； Solder the chip to the testing jig (glass epoxy board shown in the right) using eutectic solder. Then apply a force in the direction of the arrow.</p> <table border="1"> <tr> <th>尺寸 Size</th> <th>F</th> <th>保持时间 Duration</th> </tr> <tr> <td>0201, 0402, 0603</td> <td>5N</td> <td rowspan="2">10±1s</td> </tr> <tr> <td>0805</td> <td>10N</td> </tr> </table>	尺寸 Size	F	保持时间 Duration	0201, 0402, 0603	5N	10±1s	0805	10N	<p>端电极无脱落且瓷体无损伤。 No removal or split of the termination or other defects shall occur.</p> 																						
尺寸 Size	F	保持时间 Duration																															
0201, 0402, 0603	5N	10±1s																															
0805	10N																																
抗弯强度 Resistance to Flexure	IEC 60068-2-21	<p>将晶片焊接在测试基板上（如右图所示的环氧玻璃布板），按下图箭头所示方向施加作用力； Solder the chip to the test jig (glass epoxy board shown in the right) using a eutectic solder. Then apply a force in the direction shown as follow;</p>  <table border="1"> <tr> <th>尺寸 Size</th> <th>弯曲变形量 Flexure</th> <th>施压速度 Pressurizing Speed</th> <th>保持时间 Duration</th> </tr> <tr> <td>0201,</td> <td>1mm</td> <td rowspan="2">&lt;0.5mm/s</td> <td rowspan="2">10±1s</td> </tr> <tr> <td>0402, 0603, 0805</td> <td>2mm</td> </tr> </table>	尺寸 Size	弯曲变形量 Flexure	施压速度 Pressurizing Speed	保持时间 Duration	0201,	1mm	<0.5mm/s	10±1s	0402, 0603, 0805	2mm	<p>① 无外观损伤。 No visible damage. ② <math> \Delta R_{25}/R_{25}  \leq 2\%</math></p> <p>单位 unit: mm</p> <table border="1"> <tr> <th>类型 Type</th> <th>a</th> <th>b</th> <th>c</th> </tr> <tr> <td>0201</td> <td>0.25</td> <td>0.3</td> <td>0.3</td> </tr> <tr> <td>0402</td> <td>0.4</td> <td>1.5</td> <td>0.5</td> </tr> <tr> <td>0603</td> <td>1.0</td> <td>3.0</td> <td>1.2</td> </tr> <tr> <td>0805</td> <td>1.2</td> <td>4.0</td> <td>1.65</td> </tr> </table> 	类型 Type	a	b	c	0201	0.25	0.3	0.3	0402	0.4	1.5	0.5	0603	1.0	3.0	1.2	0805	1.2	4.0	1.65
尺寸 Size	弯曲变形量 Flexure	施压速度 Pressurizing Speed	保持时间 Duration																														
0201,	1mm	<0.5mm/s	10±1s																														
0402, 0603, 0805	2mm																																
类型 Type	a	b	c																														
0201	0.25	0.3	0.3																														
0402	0.4	1.5	0.5																														
0603	1.0	3.0	1.2																														
0805	1.2	4.0	1.65																														

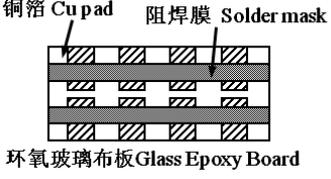
<p>振动 Vibration</p>	<p>IEC 60068-2-80</p>	<p>① 将晶片焊接在测试基板上（如右图所示的环氧玻璃布板）； Solder the chip to the testing jig (glass epoxy board shown in the left) using eutectic solder.</p> <p>② 晶片以全振幅为 1.5mm 进行振动，频率范围为 10Hz ~55 Hz； The chip shall be subjected to a simple harmonic motion having total amplitude of 1.5mm, the frequency being varied uniformly between the approximate limits of 10 and 55 Hz.</p> <p>③ 振动频率按 10Hz→55Hz→10Hz 循环，周期为 1 分钟，在空间三个互相垂直的方向上各振动 2 小时（共 6 小时）。 The frequency ranges from 10 to 55 Hz and return to 10 Hz shall be traversed in approximately 1 minute. This motion shall be applied for a period of 2 hours in each 3 mutually perpendicular directions (total of 6 hours).</p>	<p>无外观损伤。 No visible damage.</p> 															
<p>坠落 Dropping</p>	<p>IEC 60068-2-32</p>	<p>从 1m 的高度让晶片自由坠落至水泥地面 10 次。 Drop a chip 10 times on a concrete floor from a height of 1 meter.</p>	<p>无外观损伤。 No visible damage.</p>															
<p>可焊性 Solderability</p>	<p>IEC 60068-2-58</p>	<p>① 焊接温度 Solder temperature: 245±5℃. ② 浸渍时间 Duration: 3±0.3s. ③ 焊锡成分 Solder: 96.5Sn/3.0Ag/0.5Cu. ④ 助焊剂 Flux:（重量比）25%松香和 75%酒精 25% Resin and 75% ethanol in weight.</p>	<p>① 无外观损伤； No visible damage. ② 元件端电极的焊锡覆盖率不小于 95%。 Wetting shall exceed 95% coverage.</p>															
<p>耐焊性 Resistance to Soldering Heat</p>	<p>IEC 60068-2-58</p>	<p>① 焊接温度 Solder temperature: 260±5℃. ② 浸渍时间 Duration: 10±1s. ③ 焊锡成分 Solder: 96.5Sn/3.0Ag/0.5Cu. ④ 助焊剂 Flux:（重量比）25%松香和 75%酒精 25% Resin and 75% ethanol in weight. ⑤ 试验后标准条件下放置 1~2 小时后测量。 The chip shall be stabilized at normal condition for 1~2 hours before measuring.</p>	<p>① 无外观损伤； No visible damage. ② <math> \Delta R_{25}/R_{25}  \leq 2\%</math> ③ <math> \Delta B/B  \leq 1\%</math></p>															
<p>温度周期 Temperature cycling</p>	<p>IEC 60068-2-14</p>	<p>① 无负载于下表所示的环境条件下重复 5 次。 5 cycles of following sequence without loading.</p> <table border="1" data-bbox="491 1429 1040 1624"> <thead> <tr> <th>步骤 Step</th> <th>温度 Temperature</th> <th>时间 Time</th> </tr> </thead> <tbody> <tr> <td>1</td> <td>-40±5℃</td> <td>30±3min</td> </tr> <tr> <td>2</td> <td>25±2℃</td> <td>5±3min</td> </tr> <tr> <td>3</td> <td>125±2℃</td> <td>30±3min</td> </tr> <tr> <td>4</td> <td>25±2℃</td> <td>5±3min</td> </tr> </tbody> </table> <p>② 试验后标准条件下放置 1~2 小时后测量。 The chip shall be stabilized at normal condition for 1~2 hours before measuring.</p>	步骤 Step	温度 Temperature	时间 Time	1	-40±5℃	30±3min	2	25±2℃	5±3min	3	125±2℃	30±3min	4	25±2℃	5±3min	<p>① 无外观损伤； No visible damage. ② <math> \Delta R_{25}/R_{25}  \leq 2\%</math> ③ <math> \Delta B/B  \leq 1\%</math></p>
步骤 Step	温度 Temperature	时间 Time																
1	-40±5℃	30±3min																
2	25±2℃	5±3min																
3	125±2℃	30±3min																
4	25±2℃	5±3min																
<p>高温存放 Resistance to dry heat</p>	<p>IEC 60068-2-2</p>	<p>① 在 125±5℃ 空气中，无负载放置 1000±24 小时。 125±5℃ in air, for 1000±24 hours without loading. ② 试验后标准条件下放置 1~2 小时后测量。 The chip shall be stabilized at normal condition for 1~2 hours before measuring.</p>	<p>① 无外观损伤； No visible damage. ② <math> \Delta R_{25}/R_{25}  \leq 2\%</math> ③ <math> \Delta B/B  \leq 1\%</math></p>															

低温存放 Resistance to cold	IEC 60068-2-1	① 在-40±3℃空气中，无负载放置 1000±24 小时。 -40±3℃ in air, for 1000±24 hours without loading. ② 试验后标准条件下放置 1~2 小时后测量。 The chip shall be stabilized at normal condition for 1~2 hours before measuring.	① 无外观损伤； No visible damage. ② $ \Delta R25/R25  \leq 2\%$ ③ $ \Delta B/B  \leq 1\%$
湿热存放 Resistance to damp heat	IEC 60068-2-78	① 在 40±2℃，相对湿度 90~95%空气中，无负载放置 1000±24 小时。 40±2℃, 90~95%RH in air, for 1000±24 hours without loading. ② 试验后标准条件下放置 1~2 小时后测量。 The chip shall be stabilized at normal condition for 1~2 hours before measuring.	① 无外观损伤； No visible damage. ② $ \Delta R25/R25  \leq 2\%$ ③ $ \Delta B/B  \leq 1\%$
高温负荷 Resistance to high temperature load	IEC 60539-1 5.25.4	① 在 85±2℃空气中，施加允许工作电流 1000±48 小时。 85±2℃ in air with permissive operating current for 1000±48 hours ② 试验后标准条件下放置 1~2 小时后测量。 The chip shall be stabilized at normal condition for 1~2 hours before measuring.	① 无外观损伤； No visible damage. ② $ \Delta R25/R25  \leq 2\%$ ③ $ \Delta B/B  \leq 1\%$

**7 编带 Taping**

类型 Type	0201	0402	0603	0805
编带厚度 Tape thickness(mm)	0.5±0.15	0.5±0.15	0.8±0.15	0.85±0.2
编带材质 Tape material	纸带 Paper Tape			
每盘数量 Quantity per Reel	15K	10K	4K	4K

(1) 编带图 Taping Drawings

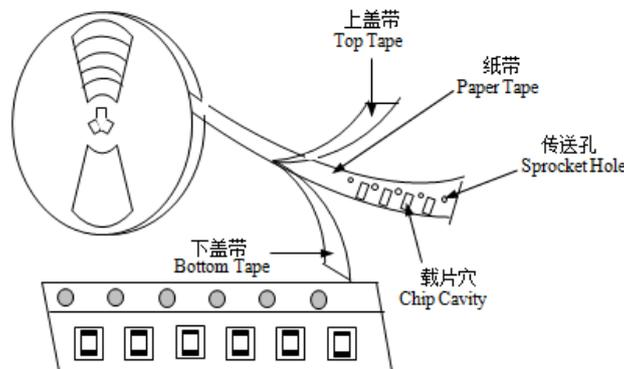

(2) 纸带尺寸 Paper Tape Dimensions (单位 Unit: mm)

QN0201 系列 QN0201 series

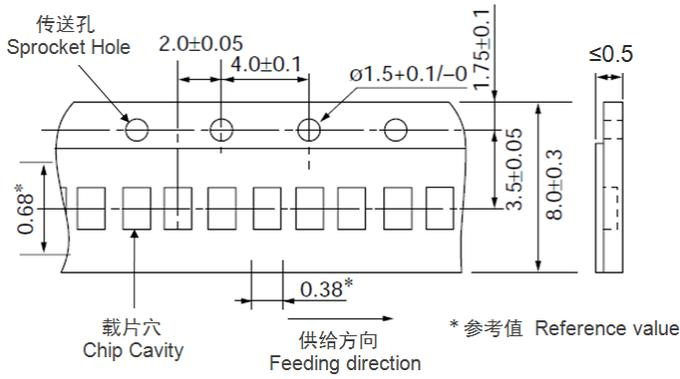

QN0402 系列 QN0402 series

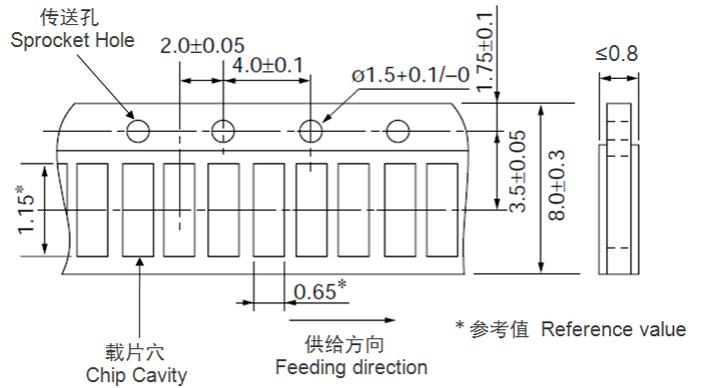

QN0603 系列 QN0603 series

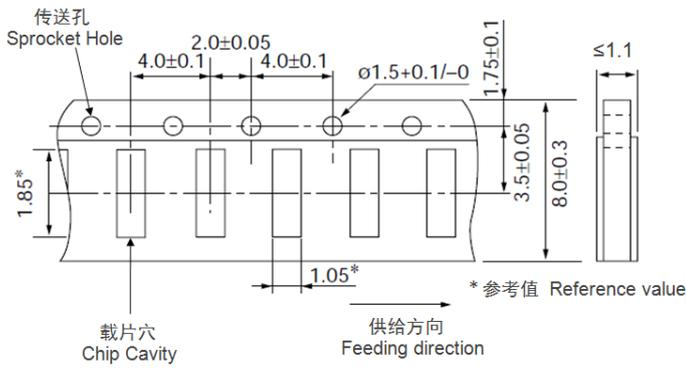

QN0805 系列 QN0805 series

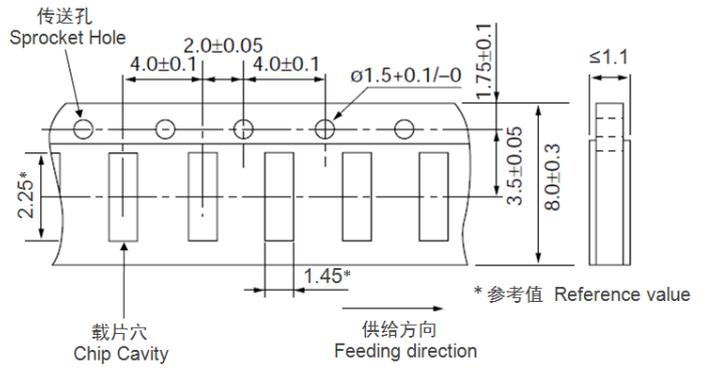

(3) 卷盘尺寸 Reel Dimensions (单位 Unit: mm)

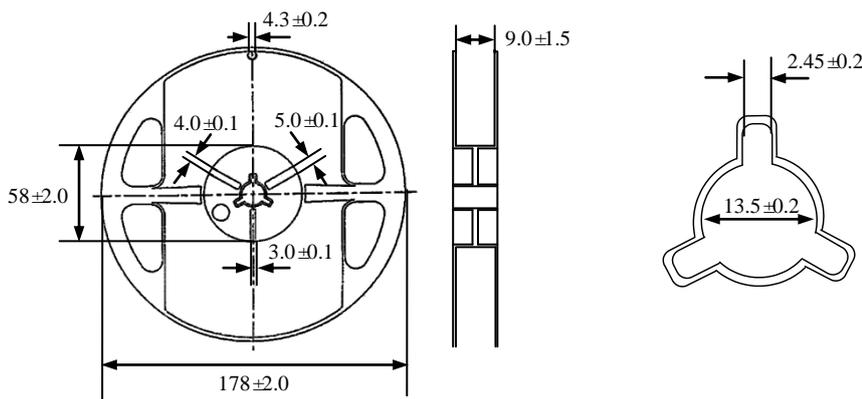

## 8 储存

- **储存条件**
  - a. 储存温度:  $-10^{\circ}\text{C} \sim 40^{\circ}\text{C}$
  - b. 相对湿度:  $\leq 75\% \text{RH}$
  - c. 避免接触粉尘、腐蚀性气氛和阳光
- **储存期限: 产品交付后 6 个月**

## 9 注意事项

- QN 系列热敏电阻不可在以下条件下工作或储存:
  - (1) 腐蚀性气体或还原性气体  
(氯气、硫化氢气体、氨气、硫酸气体、一氧化氮等)。
  - (2) 挥发性或易燃性气体
  - (3) 多尘条件
  - (4) 高压或低压条件
  - (5) 潮湿场所
  - (6) 存在盐水、油、化学液体或有机溶剂的场所
  - (7) 强烈振动
  - (8) 存在类似有害条件的其他场所
- QN 系列热敏电阻的陶瓷属于易碎材料, 使用时不可施加过大压力或冲击。
- QN 系列热敏电阻不可在超过目录规定的温度范围情况下工作。

## 8 Storage

- **Storage Conditions**
  - a. Storage Temperature:  $-10^{\circ}\text{C} \sim 40^{\circ}\text{C}$
  - b. Relative Humidity:  $\cong 75\% \text{RH}$
  - c. Keep away from corrosive atmosphere and sunlight.
- **Period of Storage: 6 Months after delivery**

## 9 Notes & Warnings

- The QN series thermistors shall not be operated and stored under the following environmental condition:
  - (1) Corrosive or deoxidized atmospheres  
(such as chlorine, sulfurated hydrogen, ammonia, sulfuric acid, nitric oxide and so on)
  - (2) Volatile or inflammable atmospheres
  - (3) Dusty condition
  - (4) Excessively high or low pressure condition
  - (5) Humid site
  - (6) Places with brine, oil, chemical liquid or organic solvent
  - (7) Intense vibration
  - (8) Places with analogously deleterious conditions
- The ceramic body of the QN series thermistors is fragile, no excessive pressure or impact shall be exerted on it.
- The QN series thermistors shall not be operated beyond the specified "Operating Temperature Range" in the catalog.

**10 建议焊接条件**

• **回流焊**

- 温升 1~2°C/sec.
- 预热：150~170°C/90±30 sec.
- 大于 240°C 时间：20~40sec
- 峰值温度：最高 260°C/10 sec.
- 焊锡：96.5Sn/3.0Ag/0.5Cu
- 回流焊：最多 2 次

**10 Recommended Soldering Technologies**

• **Re-flowing Profile**

- 1~2°C/sec. Ramp
- Pre-heating: 150~170°C/90±30 sec.
- Time above 240°C: 20~40 sec.
- Peak temperature: 260°C Max./10 sec.
- Solder paste: 96.5Sn/3.0Ag/0.5Cu
- Max.2 times for re-flowing

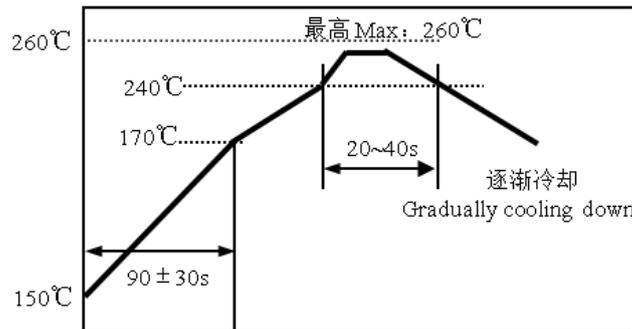

• **手工焊**

- 烙铁功率：最大 20W
- 预热：150°C/60sec.
- 烙铁头温度：最高 280°C
- 焊接时间：最多 3sec.
- 焊锡：96.5Sn/3.0Ag/0.5Cu
- 手工焊：最多 1 次

• **Iron Soldering Profile**

- Iron soldering power: Max.20W
- Pre-heating: 150°C/60sec.
- Soldering Tip temperature: 280°C Max.
- Soldering time: 3 sec Max.
- Solder paste: 96.5Sn/3.0Ag/0.5Cu
- Max.1 times for iron soldering

[注：不要使烙铁头接触到端头]

[Note: Take care not to apply the tip of the soldering iron to the terminal electrodes.]

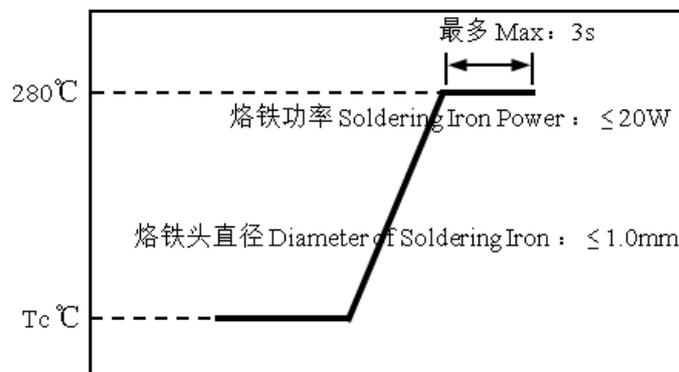

## 11 R-T 表 R-T table

## QN0402X103J3435HA

温度 Temp. (°C)	R 最小值 R_Min (Kohm)	R 中心值 R_Cent (Kohm)	R 最大值 R_Max (Kohm)	阻值公差 Res TOL.	温度公差 Temp. TOL.(°C)
-40	171.470	197.390	226.660	14.83%	2.53
-39	162.320	186.540	213.838	14.63%	2.51
-38	153.712	176.350	201.816	14.44%	2.50
-37	145.631	166.800	190.569	14.25%	2.49
-36	138.020	157.820	180.010	14.06%	2.47
-35	130.863	149.390	170.114	13.87%	2.46
-34	124.162	141.510	160.879	13.69%	2.44
-33	117.841	134.090	152.198	13.50%	2.43
-32	111.887	127.110	144.044	13.32%	2.42
-31	106.264	120.530	136.370	13.14%	2.40
-30	100.966	114.340	129.162	12.96%	2.39
-29	95.986	108.530	122.407	12.79%	2.37
-28	91.272	103.040	116.034	12.61%	2.36
-27	86.827	97.870	110.042	12.44%	2.34
-26	82.623	92.989	104.394	12.26%	2.33
-25	78.649	88.381	99.069	12.09%	2.31
-24	74.895	84.036	94.056	11.92%	2.29
-23	71.344	79.931	89.328	11.76%	2.28
-22	67.983	76.052	84.866	11.59%	2.26
-21	64.800	72.384	80.653	11.42%	2.25
-20	61.786	68.915	76.675	11.26%	2.23
-19	58.930	65.634	72.918	11.10%	2.21
-18	56.224	62.529	69.367	10.94%	2.20
-17	53.658	59.589	66.010	10.78%	2.18
-16	51.224	56.804	62.835	10.62%	2.16
-15	48.915	54.166	59.831	10.46%	2.14
-14	46.722	51.665	56.988	10.30%	2.13
-13	44.641	49.294	54.296	10.15%	2.11
-12	42.665	47.046	51.747	9.99%	2.09
-11	40.787	44.913	49.332	9.84%	2.07
-10	39.003	42.889	47.044	9.69%	2.06
-9	37.307	40.967	44.874	9.54%	2.04
-8	35.693	39.142	42.817	9.39%	2.02
-7	34.159	37.408	40.864	9.24%	2.00
-6	32.699	35.761	39.012	9.09%	1.98
-5	31.310	34.196	37.255	8.95%	1.96
-4	29.986	32.707	35.585	8.80%	1.94
-3	28.726	31.291	33.999	8.66%	1.93
-2	27.527	29.945	32.494	8.51%	1.91
-1	26.384	28.664	31.063	8.37%	1.89
0	25.295	27.445	29.703	8.23%	1.87
1	24.255	26.283	28.409	8.09%	1.85

温度 Temp. (°C)	R 最小值 R_Min (Kohm)	R 中心值 R_Cent (Kohm)	R 最大值 R_Max (Kohm)	阻值公差 Res TOL.	温度公差 Temp. TOL.(°C)
2	23.265	25.177	27.178	7.95%	1.83
3	22.320	24.124	26.008	7.81%	1.81
4	21.420	23.121	24.895	7.67%	1.79
5	20.560	22.165	23.836	7.54%	1.77
6	19.739	21.253	22.826	7.40%	1.75
7	18.955	20.384	21.865	7.27%	1.73
8	18.207	19.555	20.950	7.13%	1.71
9	17.492	18.764	20.078	7.00%	1.68
10	16.810	18.010	19.247	6.87%	1.66
11	16.158	17.290	18.455	6.74%	1.64
12	15.534	16.602	17.699	6.61%	1.62
13	14.938	15.946	16.979	6.48%	1.60
14	14.368	15.319	16.292	6.35%	1.58
15	13.823	14.720	15.636	6.22%	1.56
16	13.301	14.148	15.011	6.10%	1.53
17	12.802	13.601	14.413	5.97%	1.51
18	12.324	13.078	13.843	5.85%	1.49
19	11.867	12.578	13.298	5.72%	1.47
20	11.429	12.099	12.777	5.60%	1.45
21	11.010	11.642	12.280	5.48%	1.42
22	10.608	11.204	11.804	5.36%	1.40
23	10.223	10.785	11.350	5.24%	1.38
24	9.854	10.384	10.916	5.12%	1.35
25	9.500	10.000	10.500	5.00%	1.33
26	9.140	9.632	10.125	5.12%	1.37
27	8.796	9.280	9.766	5.24%	1.41
28	8.467	8.943	9.421	5.35%	1.45
29	8.152	8.619	9.090	5.47%	1.49
30	7.850	8.309	8.773	5.59%	1.53
31	7.561	8.012	8.468	5.70%	1.57
32	7.284	7.727	8.176	5.82%	1.62
33	7.018	7.453	7.895	5.93%	1.66
34	6.764	7.191	7.626	6.04%	1.70
35	6.520	6.939	7.366	6.16%	1.74
36	6.287	6.698	7.118	6.27%	1.78
37	6.063	6.466	6.878	6.38%	1.83
38	5.848	6.243	6.649	6.49%	1.87
39	5.642	6.029	6.428	6.61%	1.91
40	5.444	5.824	6.215	6.72%	1.96
41	5.254	5.627	6.011	6.83%	2.00
42	5.072	5.437	5.814	6.94%	2.05
43	4.897	5.255	5.625	7.05%	2.09
44	4.729	5.080	5.443	7.16%	2.14
45	4.567	4.911	5.268	7.26%	2.18
46	4.412	4.749	5.099	7.37%	2.23

温度 Temp. (°C)	R 最小值 R_Min (Kohm)	R 中心值 R_Cent (Kohm)	R 最大值 R_Max (Kohm)	阻值公差 Res TOL.	温度公差 Temp. TOL.(°C)
47	4.263	4.593	4.937	7.48%	2.27
48	4.120	4.443	4.780	7.59%	2.32
49	3.982	4.299	4.630	7.69%	2.36
50	3.849	4.160	4.485	7.80%	2.41
51	3.722	4.027	4.345	7.90%	2.46
52	3.600	3.898	4.210	8.01%	2.50
53	3.482	3.774	4.080	8.11%	2.55
54	3.368	3.654	3.955	8.22%	2.60
55	3.259	3.539	3.834	8.32%	2.65
56	3.154	3.429	3.717	8.43%	2.69
57	3.053	3.322	3.605	8.53%	2.74
58	2.956	3.219	3.497	8.63%	2.79
59	2.862	3.119	3.392	8.73%	2.84
60	2.771	3.024	3.291	8.84%	2.89
61	2.684	2.931	3.193	8.94%	2.94
62	2.600	2.842	3.099	9.04%	2.99
63	2.519	2.756	3.008	9.14%	3.04
64	2.441	2.673	2.920	9.24%	3.09
65	2.366	2.593	2.835	9.34%	3.14
66	2.293	2.516	2.753	9.44%	3.19
67	2.223	2.441	2.674	9.54%	3.24
68	2.156	2.369	2.598	9.64%	3.29
69	2.091	2.300	2.524	9.73%	3.34
70	2.028	2.233	2.452	9.83%	3.40
71	1.967	2.168	2.383	9.93%	3.45
72	1.908	2.105	2.316	10.03%	3.50
73	1.852	2.044	2.251	10.12%	3.55
74	1.797	1.986	2.189	10.22%	3.61
75	1.744	1.929	2.128	10.31%	3.66
76	1.693	1.874	2.069	10.41%	3.71
77	1.644	1.821	2.013	10.50%	3.77
78	1.596	1.770	1.958	10.60%	3.82
79	1.550	1.720	1.904	10.69%	3.87
80	1.506	1.673	1.853	10.79%	3.93
81	1.463	1.626	1.803	10.88%	3.98
82	1.421	1.581	1.755	10.97%	4.04
83	1.381	1.538	1.708	11.07%	4.10
84	1.342	1.496	1.662	11.16%	4.15
85	1.304	1.455	1.619	11.25%	4.21
86	1.268	1.416	1.576	11.34%	4.26
87	1.233	1.377	1.535	11.43%	4.32
88	1.199	1.340	1.495	11.53%	4.38
89	1.166	1.304	1.456	11.62%	4.43
90	1.134	1.270	1.418	11.71%	4.49
91	1.103	1.236	1.382	11.80%	4.55

温度 Temp. (°C)	R 最小值 R_Min (Kohm)	R 中心值 R_Cent (Kohm)	R 最大值 R_Max (Kohm)	阻值公差 Res TOL.	温度公差 Temp. TOL.(°C)
92	1.073	1.204	1.347	11.89%	4.61
93	1.044	1.172	1.312	11.98%	4.66
94	1.016	1.141	1.279	12.06%	4.72
95	0.989	1.112	1.247	12.15%	4.78
96	0.962	1.083	1.215	12.24%	4.84
97	0.937	1.055	1.185	12.33%	4.90
98	0.912	1.028	1.155	12.42%	4.96
99	0.888	1.002	1.127	12.50%	5.02
100	0.865	0.976	1.099	12.59%	5.08
101	0.842	0.951	1.072	12.68%	5.14
102	0.820	0.927	1.046	12.76%	5.20
103	0.799	0.904	1.020	12.85%	5.26
104	0.779	0.882	0.996	12.94%	5.32
105	0.759	0.860	0.972	13.02%	5.38
106	0.739	0.838	0.948	13.11%	5.45
107	0.721	0.818	0.926	13.19%	5.51
108	0.702	0.798	0.904	13.28%	5.57
109	0.685	0.778	0.882	13.36%	5.63
110	0.668	0.759	0.861	13.44%	5.70
111	0.651	0.741	0.841	13.53%	5.76
112	0.635	0.723	0.822	13.61%	5.82
113	0.619	0.706	0.802	13.69%	5.89
114	0.604	0.689	0.784	13.77%	5.95
115	0.589	0.673	0.766	13.86%	6.01
116	0.575	0.657	0.748	13.94%	6.08
117	0.561	0.641	0.731	14.02%	6.14
118	0.548	0.626	0.715	14.10%	6.21
119	0.534	0.612	0.699	14.18%	6.27
120	0.522	0.598	0.683	14.26%	6.34
121	0.509	0.584	0.668	14.34%	6.41
122	0.497	0.570	0.653	14.42%	6.47
123	0.486	0.557	0.638	14.50%	6.54
124	0.474	0.545	0.624	14.58%	6.61
125	0.463	0.532	0.610	14.66%	6.67

## X-ON Electronics

Largest Supplier of Electrical and Electronic Components

*Click to view similar products for [NTC Thermistors](#) category:*

*Click to view products by [QAMcn](#) manufacturer:*

Other Similar products are found below :

[GA10K4D25](#) [GAG22K7MCD419](#) [118-253FAJ-P01](#) [121-202EAC-P01](#) [123-802EAJ-P01](#) [128-105NDP-Q02](#) [129-202VME-S01](#) [135-103LZF-J02](#) [135-503LAD-J01](#) [B57620C472K962](#) [B57620C5103K062](#) [B59970C0080A070](#) [199-303KAF-A02](#) [GA100K6MBD1](#) [B57423V2473H062](#) [B57471V2474H062](#) [B57620C5102J062](#) [B57620C5223J062](#) [111-802EAJ-901](#) [112-103FAG-H02](#) [111-182CAG-H01](#) [112-103FAF-H01](#) [112-202EAJ-B02](#) [118-202CAJ-P01](#) [NTC0805J100K](#) [B57442V5103J62](#) [B59100M1140A070](#) [B57401V2103H62](#) [NTC0805J3K3](#) [PTCTL8NR100HBE](#) [194303KEVA01](#) [NTCACAPE3C90193](#) [GAG10K3976B1](#) [B57250V2104F360](#) [GAG10K3976A1](#) [NXRT15WB473FA1B040](#) [50070974-003-01](#) [B57250V2473F560](#) [189-602LDR-A01](#) [B57621C5472K062](#) [135-105QAF-J02](#) [NTCASCWE3222J](#) [B57421V2153J062](#) [B57230V2103H260](#) [B57471V2684H062](#) [B57471V2333H062](#) [126-153YJC-B01](#) [NTCS0603E3333FHT](#) [GA10K4D67](#) [118-802EAJ-P01](#)