

## Applications

- Usable Bandwidth of 74 MHz (CH1-12)
- High-power WLAN Access Points and Small Cells
- Band-edge filtering of WiFi signal emissions at 2390 MHz and 2483.5 MHz
- WiFi bandpass filter that enables the coexistence of 4G (LTE/TD-LTE) & WiFi signals
- ISM band applications such as Smart Meters
- Portable Hotspots and Mobile Routers

## Product Features

- Industry leading small size: 1.70 x 1.30 x 0.46 mm
- Performance over -40 to +95° C
- High Rejection at 2390 MHz, 2483.5 MHz, B38/B40/B7/B41
- Ceramic chip-scale Package (CSP)
- Hermetically sealed
- RoHS compliant, Pb-free 

## General Description

The 885135 is a high-performance, high power Bulk Acoustic Wave (BAW) band-pass filter with extremely steep skirts, simultaneously exhibiting low loss in the WiFi band and high rejection in the band-edge and adjacent LTE /TD-LTE bands.

The 885135 enables coexistence of WiFi and LTE signals within the same device or in close proximity to one another. Its unique power handling capability allows for implementation into high performance high power access points and small cell base stations.

The 885135 uses common module packaging techniques to achieve the industry standard 1.7 x 1.32 x 0.46 mm footprint. The filter exhibits industry leading power handling capabilities up to 1 W.

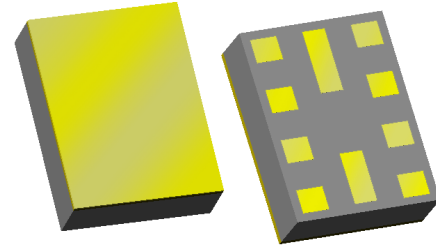

CSP-1713 package: 1.70 x 1.30 x 0.46 mm

## Functional Block Diagram

Top View

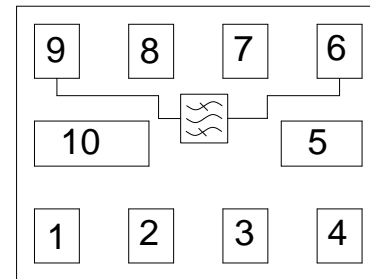

## Pin Configuration

Pin No.	Label
9	Input
6	Output
1,2,3,4,5,7,8,10	Case Ground

## Ordering Information

Part No.	Description
885135	Packaged part
885135-EVB	Evaluation board

Standard T/R size = 15,000 units/reel

## Absolute Maximum Ratings

Parameter	Rating
Storage Temperature <sup>(1)</sup>	-55 to +125 °C
Operating Temperature	-40 to +95 °C

1. Operation of this device outside the parameter ranges given may cause permanent damage.

## Electrical Specifications <sup>(1)</sup>

Conditions unless otherwise noted: Device Temperature = -40 °C to +95 °C.

Parameter <sup>(2)</sup>	Conditions	Min	Typ <sup>(3)</sup>	Max	Units
Insertion Loss <sup>(4)</sup>	2402.5 – 2421.5 MHz (WiFi Ch.1)	-	1.2	1.7	dB
	2407.5 – 2426.5 MHz (WiFi Ch.2)		0.9	1.2	
	2412.5 – 2461.5 MHz (WiFi Ch.3-9)		0.8	1.1	
	2447.5 – 2466.5 MHz (WiFi Ch.10)		0.8	1.1	
	2452.5 – 2471.5 MHz (WiFi Ch.11)		0.9	1.3	
	2457.5 – 2476.5 MHz (WiFi Ch. 12)		1.1	1.7	
Amplitude Variation	2402.5 – 2421.5 MHz (WiFi Ch.1)	-	1.3	2.8	dB
	2407.5 – 2426.5 MHz (WiFi Ch.2)		0.7	1.2	
	2412.5 – 2461.5 MHz (WiFi Ch.3-9)		0.4	0.8	
	2447.5 – 2466.5 MHz (WiFi Ch.10)		0.3	0.7	
	2452.5 – 2471.5 MHz (WiFi Ch.11)		0.5	1.1	
	2457.5 – 2476.5 MHz (WiFi Ch. 12)		1.1	3.5	
Input/Output VSWR	2402.5 – 2476.5 MHz	-	1.5 <sup>(6)</sup>	2.0 <sup>(6)</sup>	-
Attenuation	100 – 2300 MHz	22	23	-	dB
	2300 – 2370 MHz <sup>(5)</sup>	20	25		
	2370 – 2390 MHz <sup>(5)</sup>	16	19		
	2483.5 – 2500 MHz <sup>(5)</sup> (-20 °C to +25 °C)	6	20		
	2483.5 – 2500 MHz <sup>(5)</sup> (+25 °C to +95 °C)	15	20		
	2500 – 2520 MHz <sup>(5)</sup>	24	33		
	2520 – 2570 MHz <sup>(5)</sup>	29	32		
	2570 – 2620 MHz <sup>(5)</sup>	26	28		
	2620 – 2690 MHz <sup>(5)</sup>	25	28		
4800 – 5000 MHz	25	29			
Source/Load Impedance <sup>(7)</sup>		-	50	-	Ω

### Notes:

- In production, devices will be tested at room temperature to a guard-banded specification to ensure electrical compliance over temperature
- Electrical margin has been built into the design to account for the variations due to temperature drift and manufacturing tolerances
- Only at +25 °C.
- Data is the integrated value of the linear s-parameter over a 19 MHz range in the indicated band at the specified temperature.
- Data is the integrated value of the linear s-parameter over a 5 MHz range at the specified temperature.
- An external impedance matching network with ±3% tolerance will be necessary to achieve the stated specifications.
- This is the optimum impedance in order to achieve the performance shown

## Electrical Specifications <sup>(1)</sup>

Conditions unless otherwise noted: Device Temperature = -30 °C to +85 °C.

Parameter <sup>(2)</sup>	Conditions	Min	Typ <sup>(3)</sup>	Max	Units
Insertion Loss <sup>(4)</sup>	2402.5 – 2421.5 MHz (WiFi Ch.1)	-	1.2	1.6	dB
	2407.5 – 2426.5 MHz (WiFi Ch.2)		0.9	1.2	
	2412.5 – 2461.5 MHz (WiFi Ch.3 - 9)		0.8	1.1	
	2447.5 – 2466.5 MHz (WiFi Ch.10)		0.8	1.1	
	2452.5 – 2471.5 MHz (WiFi Ch.11)		0.9	1.3	
	2457.5 – 2476.5 MHz (WiFi Ch.12)		1.1	1.6	
Amplitude Variation	2402.5 – 2421.5 MHz (WiFi Ch.1)	-	1.3	2.6	dB
	2407.5 – 2426.5 MHz (WiFi Ch.2)		0.7	1.1	
	2412.5 – 2461.5 MHz (WiFi Ch.3 - 9)		0.4	0.8	
	2447.5 – 2466.5 MHz (WiFi Ch.10)		0.3	0.7	
	2452.5 – 2471.5 MHz (WiFi Ch.11)		0.5	1.1	
	2457.5 – 2476.5 MHz (WiFi Ch.12)		1.1	3.1	
Input/Output VSWR	2402.5 – 2476.5 MHz	-	1.5 <sup>(6)</sup>	2.0 <sup>(6)</sup>	-
Attenuation	100 – 2300 MHz	22	23	-	dB
	2300 – 2370 MHz <sup>(5)</sup>	20	25		
	2370 – 2390 MHz <sup>(5)</sup>	16	19		
	2483.5 – 2500 MHz <sup>(5)</sup> (-20 °C to +25 °C)	6	20		
	2483.5 – 2500 MHz <sup>(5)</sup> (+25 °C to +85 °C)	15	20		
	2500 – 2520 MHz <sup>(5)</sup>	24	33		
	2520 – 2570 MHz <sup>(5)</sup>	29	32		
	2570 – 2620 MHz <sup>(5)</sup>	26	28		
2620 – 2690 MHz <sup>(5)</sup>	25	28			
4800 – 5000 MHz	25	29			
Source/Load Impedance <sup>(7)</sup>		-	50	-	Ω

### Notes:

1. In production, devices will be tested at room temperature to a guard-banded specification to ensure electrical compliance over temperature
2. Electrical margin has been built into the design to account for the variations due to temperature drift and manufacturing tolerances
3. Only at +25 °C.
4. Data is the integrated value of the linear s-parameter over a 19 MHz range in the indicated band at the specified temperature.
5. Data is the integrated value of the linear s-parameter over a 5 MHz range at the specified temperature.
6. An external impedance matching network with ±3 % tolerance will be necessary to achieve the stated specifications.
7. This is the optimum impedance in order to achieve the performance shown

## Electrical Specifications <sup>(1)</sup>

Conditions unless otherwise noted: Device Temperature = 0 °C to +70 °C.

Parameter <sup>(2)</sup>	Conditions	Min	Typ <sup>(3)</sup>	Max	Units
Insertion Loss <sup>(4)</sup>	2402.5 – 2421.5 MHz (WiFi Ch.1)		1.2	1.5	dB
	2407.5 – 2426.5 MHz (WiFi Ch.2)		0.9	1.2	
	2412.5 – 2461.5 MHz (WiFi Ch.3-9)		0.8	1.1	
	2447.5 – 2466.5 MHz (WiFi Ch.10)		0.8	1.0	
	2452.5 – 2471.5 MHz (WiFi Ch.11)		0.9	1.2	
	2457.5 – 2476.5 MHz (WiFi Ch. 12)		1.1	1.5	
Amplitude Variation	2402.5 – 2421.5 MHz (WiFi Ch.1)		1.3	2.3	dB
	2407.5 – 2426.5 MHz (WiFi Ch.2)		0.7	1.1	
	2412.5 – 2461.5 MHz (WiFi Ch.3-9)		0.4	0.7	
	2447.5 – 2466.5 MHz (WiFi Ch.10)		0.3	0.6	
	2452.5 – 2471.5 MHz (WiFi Ch.11)		0.5	1.3	
	2457.5 – 2476.5 MHz (WiFi Ch. 12)		1.1	2.6	
Input/Output VSWR	2402.5 – 2471.5 MHz	-	1.5 <sup>(6)</sup>	2.0 <sup>(6)</sup>	-
Attenuation	100 – 2300 MHz	22	23		dB
	2300 – 2370 MHz <sup>(5)</sup>	20	25		
	2370 – 2390 MHz <sup>(5)</sup>	16	19		
	2483.5 – 2500 MHz <sup>(5)</sup> ( 0 °C to +25 °C)	9	20		
	2483.5 – 2500 MHz <sup>(5)</sup> ( +25 °C to +70 °C)	15	20	-	
	2500 – 2520 MHz <sup>(5)</sup>	23	33		
	2520 – 2570 MHz <sup>(5)</sup>	30	32		
	2570 – 2620 MHz <sup>(5)</sup>	26	28		
	2620 – 2690 MHz <sup>(5)</sup>	25	28		
4800 – 5000 MHz	25	29			
Source/Load Impedance <sup>(7)</sup>		-	50	-	Ω

Notes:

1. In production, devices will be tested at room temperature to a guard-banded specification to ensure electrical compliance over temperature
2. Electrical margin has been built into the design to account for the variations due to temperature drift and manufacturing tolerances
3. Only at +25 °C.
4. Data is the integrated value of the linear s-parameter over a 19 MHz range in the indicated band at the specified temperature.
5. Data is the integrated value of the linear s-parameter over a 5 MHz range at the specified temperature.
6. An external impedance matching network with ±3 % tolerance will be necessary to achieve the stated specifications.
7. This is the optimum impedance in order to achieve the performance shown

**Evaluation Board**

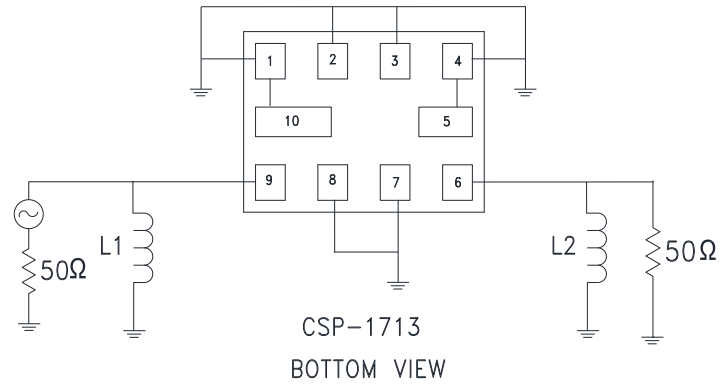
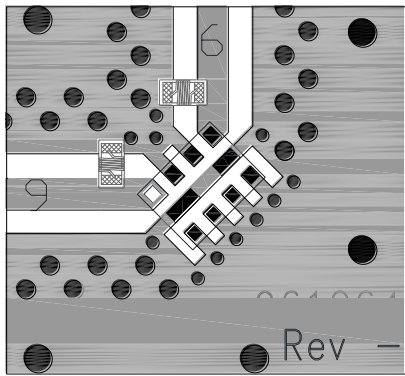

**Notes:**

1. Matching component values shown are for the specified TriQuint evaluation board. Value adjustment may be required in end user product circuits depending on component manufacturer and PCB material.
2. PCB: .500 x.500 x .062; Construction: ½ oz Cu Top Layer; TLY-5A (.0075) ½ oz Cu Middle Layer, FR4; ½ oz Cu Bottom Layer. (dimensions are in inches)

**Bill of Material**

Reference Des.	Value	Description	Manuf.	Part Number
L1	15 nH	Chip Inductor, 0402, ± 3 %	Murata	LQW15AN15NH00
L2	15 nH	Chip Inductor, 0402, ± 3 %	Murata	LQW15AN15NH00
SMA	N/A	SMA connector	Radiall USA	9602-1111-018
PCB	N/A	3-layer	Multiple	961064

**PCB Mounting Pattern**

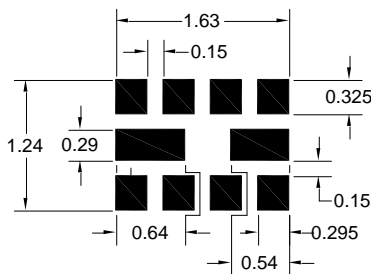

**Notes:**

1. All dimensions are in millimeters. Angles are in degrees.
2. This drawing specifies the mounting pattern used on the TriQuint evaluation board for this product. Some modification may be necessary to suit end user assembly materials and processes.

**Performance Plots**

Test conditions unless otherwise noted: Temp= +25 °C

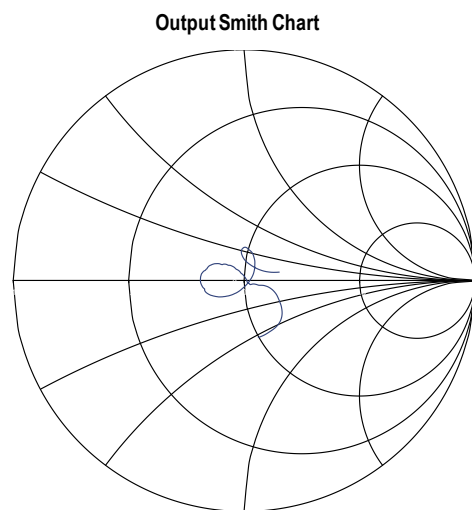
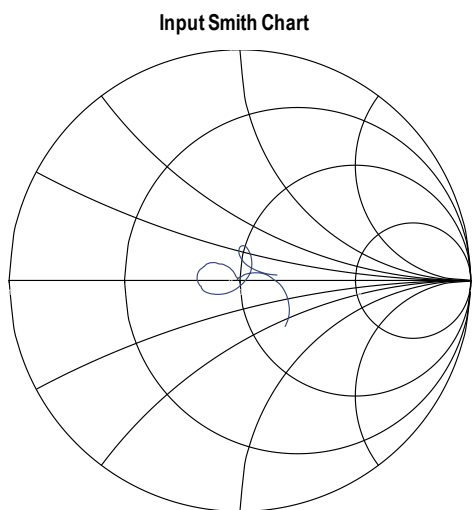
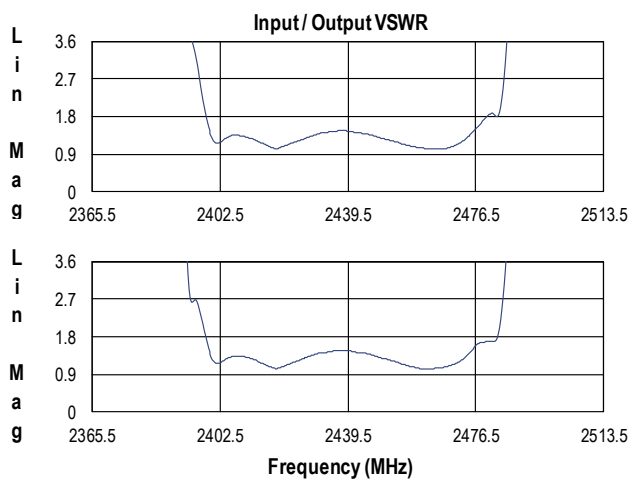
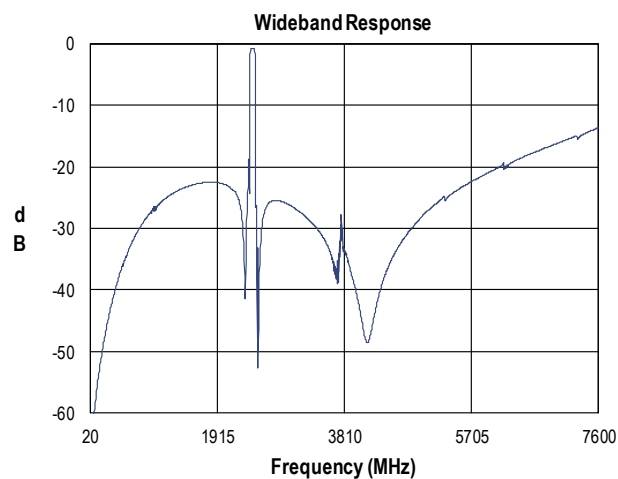
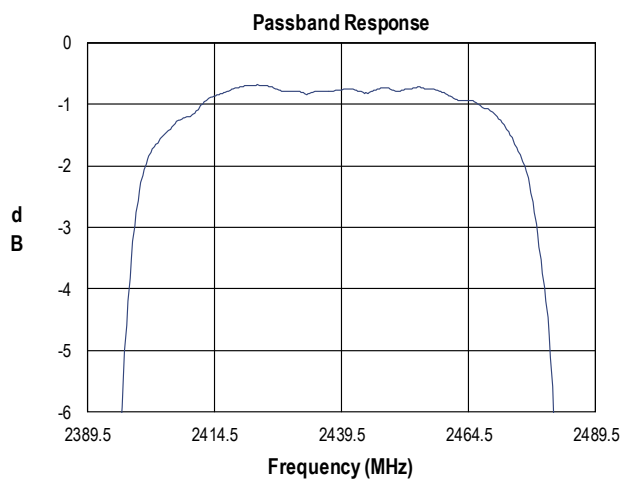
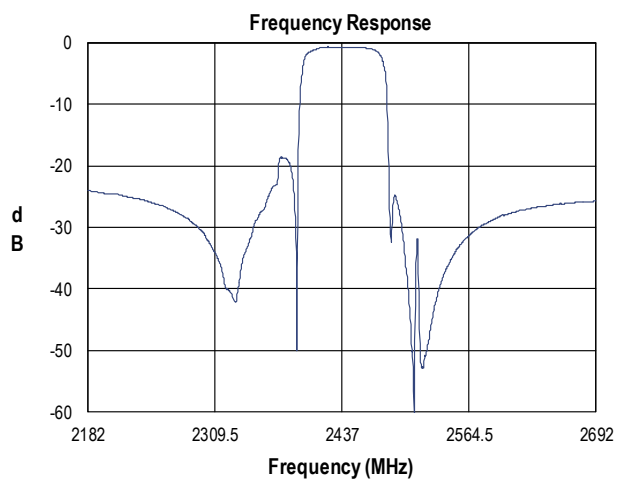

**Package Information, Marking and Dimensions**

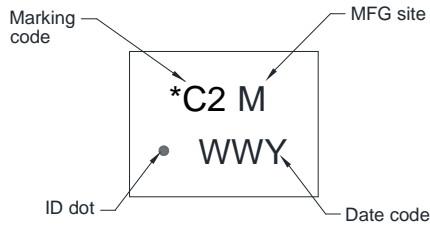

Package Style: CSP-1713  
 Dimensions: 1.7 x 1.3 x 0.50 mm

Package for Surface Mount Technology  
 Terminations: Au plating 0.5 - 1.0 μm, over a 2-6 μm Ni Plating  
 Approximate weight 3.96 mg

All dimensions shown are nominal in millimeters.  
 Unless otherwise specified all tolerances are ±0.05mm except length and width that are specified as ±0.1mm

The Marking Code is correlated with the Part Number  
 M=Manufacturing Site Code (Blank for Apopka, C for Costa Rica)  
 The Date Code consists of:  
 WW = 2 digit week  
 Y=The last digit of the year

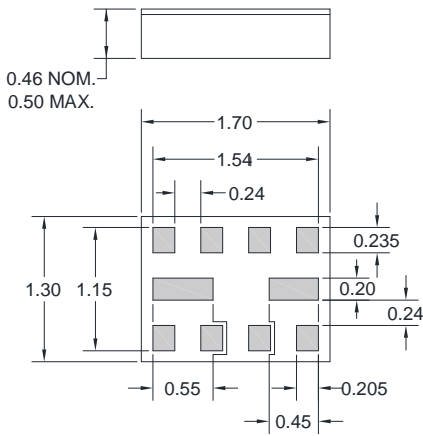

- Notes:
1. All dimensions shown are typical in millimeters
  2. An asterisk (\*) in front of the marking code indicates prototype.

**Tape and Reel information**

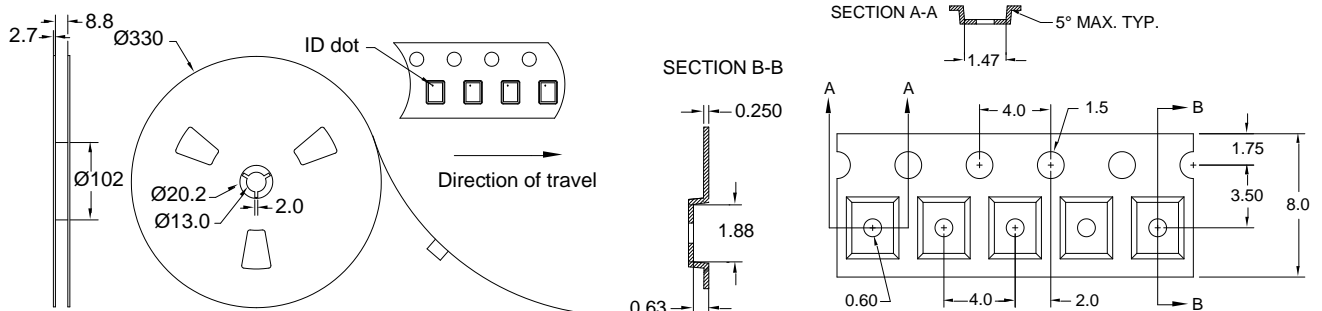

Standard T/R size=15,000 units/reel. All dimensions are in millimeters.

## Product Compliance Information

### ESD Sensitivity Ratings



Caution! ESD-Sensitive Device

### MSL Rating

Not applicable. Hermetic package.

### Solderability

Compatible with the latest version of J-STD-020, lead free solder, 260°C

Refer to [Soldering Profile](#) for recommended guidelines.

### RoHs Compliance

This part is compliant with EU 2002/95/EC RoHS directive (Restrictions on the Use of Certain Hazardous Substances in Electrical and Electronic Equipment).

This product also has the following attributes:

- Halogen Free (Chlorine, Bromine)
- Antimony Free
- TBBP-A (C<sub>15</sub>H<sub>12</sub>Br<sub>4</sub>O<sub>2</sub>) Free
- PFOS Free
- SVHC Free

## Contact Information

For the latest specifications, additional product information, worldwide sales and distribution locations, and information about TriQuint:

**Web:** [www.triquint.com](http://www.triquint.com)  
**Email:** [info-sales@tqs.com](mailto:info-sales@tqs.com)

**Tel:** +1.407.886.8860  
**Fax:** +1.407.886.7061

For technical questions and application information: **Email:** [flapplication.engineering@tqs.com](mailto:flapplication.engineering@tqs.com)

## Important Notice

The information contained herein is believed to be reliable. TriQuint makes no warranties regarding the information contained herein. TriQuint assumes no responsibility or liability whatsoever for any of the information contained herein. TriQuint assumes no responsibility or liability whatsoever for the use of the information contained herein. The information contained herein is provided "AS IS, WHERE IS" and with all faults, and the entire risk associated with such information is entirely with the user. All information contained herein is subject to change without notice. Customers should obtain and verify the latest relevant information before placing orders for TriQuint products. The information contained herein or any use of such information does not grant, explicitly or implicitly, to any party any patent rights, licenses, or any other intellectual property rights, whether with regard to such information itself or anything described by such information.

TriQuint products are not warranted or authorized for use as critical components in medical, life-saving, or life-sustaining applications, or other applications where a failure would reasonably be expected to cause severe personal injury or death.



## X-ON Electronics

Largest Supplier of Electrical and Electronic Components

*Click to view similar products for [Signal Conditioning](#) category:*

*Click to view products by [Qorvo](#) manufacturer:*

Other Similar products are found below :

[MAPDCC0001](#) [MAPDCC0004](#) [PD0409J5050S2HF](#) [880157](#) [HHS-109-PIN](#) [DC1417J5005AHF](#) [AFS14A30-2185.00-T3](#) [AFS14A35-1591.50-T3](#) [DS-323-PIN](#) [B39321R801H210](#) [1A0220-3](#) [JP510S](#) [LFB212G45SG8C341](#) [LFB322G45SN1A504](#) [LFL182G45TC3B746](#) [SF2159E](#) [30057](#) [FM-104-PIN](#) [CER0813B](#) [MAPDCC0005](#) [3A325](#) [40287](#) [41180](#) [ATB3225-75032NCT](#) [BD0810N50100AHF](#) [BD2425J50200AHF](#) [C5060J5003AHF](#) [JHS-115-PIN](#) [JP503AS](#) [DC0710J5005AHF](#) [DC2327J5005AHF](#) [DC3338J5005AHF](#) [43020](#) [LFB2H2G60BB1C106](#) [LFL15869MTC1B787](#) [X3C19F1-20S](#) [XC3500P-20S](#) [10013-20](#) [SF2194E](#) [CDBLB455KCAX39-B0](#) [TGL2208-SM, EVAL](#) [RF1353C](#) [1E1305-3](#) [1F1304-3S](#) [1G1304-30](#) [B0922J7575AHF](#) [2020-6622-20](#) [10017-3](#) [TP-103-PIN](#) [BD1222J50200AHF](#)