

General Description

The 885136 is a high-performance, high power Bulk Acoustic Wave (BAW) band-pass filter with extremely steep skirts, simultaneously exhibiting low loss in the WiFi band and high rejection in the band-edge and adjacent LTE /TD-LTE bands.

The 885136 enables coexistence of WiFi and LTE signals within the same device or in close proximity to one another. Its unique power handling capability allows for implementation into high performance high power access points and small cell base stations.

The 885136 uses common module packaging techniques to achieve the industry standard 1.1 x 0.9 x 0.50 mm footprint.

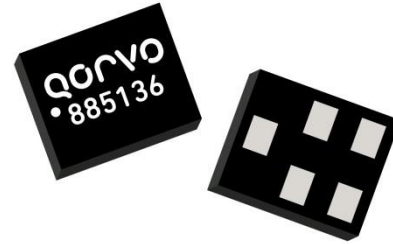

1.1 X 0.9 X 0.50 mm

Product Features

- Industry leading small size: 1.1 x 0.9 x 0.50 mm
- Performance over -40 to +95° C
- High Rejection at 2390 MHz, 2483.5 MHz, B38/B40/B7/B41
- Single Ended Operation
- RoHS Compliant, Pb-Free



Functional Block Diagram

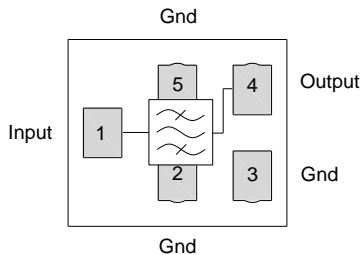

Top View

Pin Configuration - Single Ended

Pin No.	Label
1	Input
4	Output
2,3,5	Ground

Applications

- Usable Bandwidth of 69 MHz (CH1-11)
- High-power WLAN Access Points and Small Cells
- Band-edge filtering of WiFi signal emissions at 2390 MHz and 2483.5 MHz
- WiFi bandpass filter that enables the coexistence of 4G (LTE/TD-LTE) & WiFi signals
- ISM band applications such as Smart Meters
- Portable Hotspots and Mobile Routers

Ordering Information

Part No.	Description
885136	Packaged Part
885136-EVB	Evaluation board

Standard T/R size = 15,000 units/reel

Absolute Maximum Ratings

Parameter	Rating ⁽¹⁾
Storage Temperature	-40 to +125 °C
Operating Temperature	-40 to +105 °C
Max RF Signal, CW, 25 °C, 20msec	+39 dBm

Note:

(1) Exceeding any one or a combination of the Maximum Rating conditions may cause permanent damage to the device. Extended application of Maximum Rating conditions to the device may reduce device reliability.

Minimum Lifetime Ratings

Conditions ⁽¹⁾	Rating
+30 dBm, +85 °C	>300K Hrs.
+27 dBm, +95 °C	>1.1M Hrs.
+25 dBm, +105 °C	>2.9M Hrs.

Note:

(1) Average input power using a WLAN OFDM signal applied to Pin 1 only at the specified ambient temperature (power handling and nonlinear characteristics are not symmetric). Signal modulation was 802.11n, MCS7, PAR = 10 dB, 100% duty cycle.

Electrical Specifications ⁽¹⁾

Test conditions unless otherwise noted: ⁽²⁾ Temp= -40 °C to +95 °C

Parameter ⁽³⁾	Conditions	Min	Typ ⁽⁴⁾	Max	Units
Insertion Loss ⁽⁵⁾	2402.5 – 2421.5 MHz (WiFi Ch.1)		1.2	1.7	dB
	2407.5 – 2426.5 MHz (WiFi Ch.2)		1.0	1.2	
	2412.5 – 2461.5 MHz (WiFi Ch.3 - 9)	-	0.8	1.1	
	2447.5 – 2466.5 MHz (WiFi Ch.10)		0.9	1.2	
	2452.5 – 2471.5 MHz (WiFi Ch.11)		1.0	1.6	
Amplitude Variation	2402.5 – 2421.5 MHz (WiFi Ch.1)		1.5	3.0	dB p-p
	2407.5 – 2426.5 MHz (WiFi Ch.2)	-	0.8	1.5	
	2412.5 – 2461.5 MHz (WiFi Ch.3 - 9)	-	0.5	1.1	
	2447.5 – 2466.5 MHz (WiFi Ch.10)		0.5	1.2	
	2452.5 – 2471.5 MHz (WiFi Ch.11)		1.0	3.5	
Absolute Attenuation ⁽⁶⁾	100 – 2300 MHz	20	23		dB
	2300 – 2370 MHz ⁽⁶⁾	25	28		
	2370 – 2390 MHz ⁽⁶⁾	25	31		
	2483.5 – 2500 MHz ⁽⁶⁾	15	24		
	2500 – 2520 MHz ⁽⁶⁾	20	25	-	
	2520 – 2570 MHz ⁽⁶⁾	25	31		
	2570 – 2620 MHz ⁽⁶⁾	24	28		
	2620 – 2690 MHz ⁽⁶⁾	23	27		
4800 – 5000 MHz	28	31			
Input/Output VSWR ⁽⁷⁾	2402.5 – 2471.5 MHz	-	1.5	2.0:1	-
Source Impedance ⁽⁸⁾	single-ended	-	50	-	Ω
Load Impedance ⁽⁸⁾	single-ended	-	50	-	Ω

Notes:

- All specifications are based on the Qorvo schematic for the reference design shown on page 5.
- In production, devices will be tested at room temperature to a guardbanded specification to ensure electrical compliance over temperature.
- Electrical margin has been built into design to account the variations due to temperature drift and manufacturing tolerances..
- Only at 25 °C.
- Data is the integrated value of the linear s-parameter over a 19 MHz range in the indicated band at the specified temperature.
- Data is the integrated value of the linear s-parameter over 5 MHz range at the specified temperature.
- An external impedance matching network with ±3 % tolerance will be necessary to achieve the stated specifications.
- This is the optimum impedance in order to achieve the performance shown.

Electrical Specifications ⁽¹⁾

Test conditions unless otherwise noted: ⁽²⁾ Temp= -30 °C to +85 °C

Parameter ⁽³⁾	Conditions	Min	Typ ⁽⁴⁾	Max	Units
Insertion Loss ⁽⁵⁾	2402.5 – 2421.5 MHz (WiFi Ch.1)	-	1.2	1.6	dB
	2407.5 – 2426.5 MHz (WiFi Ch.2)		1.0	1.2	
	2412.5 – 2461.5 MHz (WiFi Ch.3 - 9)		0.8	1.1	
	2447.5 – 2466.5 MHz (WiFi Ch.10)		0.9	1.2	
	2452.5 – 2471.5 MHz (WiFi Ch.11)		1.0	1.6	
Amplitude Variation	2402.5 – 2421.5 MHz (WiFi Ch.1)	-	1.5	2.8	dB p-p
	2407.5 – 2426.5 MHz (WiFi Ch.2)		0.8	1.4	
	2412.5 – 2461.5 MHz (WiFi Ch.3 - 9)	-	0.5	1.0	
	2447.5 – 2466.5 MHz (WiFi Ch.10)		0.5	1.2	
	2452.5 – 2471.5 MHz (WiFi Ch.11)		1.0	3.0	
Absolute Attenuation ⁽⁶⁾	100 – 2300 MHz	20	23	-	dB
	2300 – 2370 MHz ⁽⁶⁾	25	28		
	2370 – 2390 MHz ⁽⁶⁾	28	31		
	2483.5 – 2500 MHz ⁽⁶⁾	20	25		
	2500 – 2520 MHz ⁽⁶⁾	20	25		
	2520 – 2570 MHz ⁽⁶⁾	25	31		
	2570 – 2620 MHz ⁽⁶⁾	24	28		
	2620 – 2690 MHz ⁽⁶⁾	23	27		
4800 – 5000 MHz	28	31			
Input/Output VSWR ⁽⁷⁾	2402.5 – 2471.5 MHz	-	1.5	1.8:1	-
Source Impedance ⁽⁸⁾	single-ended	-	50	-	Ω
Load Impedance ⁽⁸⁾	single-ended	-	50	-	Ω

Notes:

1. All specifications are based on the Qorvo schematic for the reference design shown on page 5.
2. In production, devices will be tested at room temperature to a guardbanded specification to ensure electrical compliance over temperature.
3. Electrical margin has been built into design to account the variations due to temperature drift and manufacturing tolerances..
4. Only at 25 °C.
5. Data is the integrated value of the linear s-parameter over a 19 MHz range in the indicated band at the specified temperature.
6. Data is the integrated value of the linear s-parameter over 5 MHz range at the specified temperature.
7. An external impedance matching network with ±3 % tolerance will be necessary to achieve the stated specifications.
8. This is the optimum impedance in order to achieve the performance shown.

Electrical Specifications ⁽¹⁾

Test conditions unless otherwise noted: ⁽²⁾ Temp= 0 °C to +70 °C

Parameter ⁽³⁾	Conditions	Min	Typ ⁽⁴⁾	Max	Units
Insertion Loss ⁽⁵⁾	2402.5 – 2421.5 MHz (WiFi Ch.1)	-	1.2	1.5	dB
	2407.5 – 2426.5 MHz (WiFi Ch.2)		1.0	1.2	
	2412.5 – 2461.5 MHz (WiFi Ch.3 - 9)		0.8	1.1	
	2447.5 – 2466.5 MHz (WiFi Ch.10)		0.9	1.1	
	2452.5 – 2471.5 MHz (WiFi Ch.11)		1.0	1.5	
Amplitude Variation	2402.5 – 2421.5 MHz (WiFi Ch.1)	-	1.5	2.5	dB p-p
	2407.5 – 2426.5 MHz (WiFi Ch.2)		0.8	1.3	
	2412.5 – 2461.5 MHz (WiFi Ch.3 - 9)		0.5	1.0	
	2447.5 – 2466.5 MHz (WiFi Ch.10)		0.5	1.0	
	2452.5 – 2471.5 MHz (WiFi Ch.11)		1.0	2.5	
Absolute Attenuation ⁽⁶⁾	100 – 2300 MHz	20	23	-	dB
	2300 – 2370 MHz ⁽⁶⁾	25	28		
	2370 – 2390 MHz ⁽⁶⁾	28	31		
	2483.5 – 2500 MHz ⁽⁶⁾	20	25		
	2500 – 2520 MHz ⁽⁶⁾	20	25		
	2520 – 2570 MHz ⁽⁶⁾	25	31		
	2570 – 2620 MHz ⁽⁶⁾	24	28		
	2620 – 2690 MHz ⁽⁶⁾	23	27		
4800 – 5000 MHz	28	31			
Input/Output VSWR ⁽⁷⁾	2402.5 – 2471.5 MHz	-	1.5	1.8:1	-
Source Impedance ⁽⁸⁾	single-ended	-	50	-	Ω
Load Impedance ⁽⁸⁾	single-ended	-	50	-	Ω

Notes:

1. All specifications are based on the Qorvo schematic for the reference design shown on page 5.
2. In production, devices will be tested at room temperature to a guardbanded specification to ensure electrical compliance over temperature.
3. Electrical margin has been built into design to account the variations due to temperature drift and manufacturing tolerances..
4. Only at 25 °C.
5. Data is the integrated value of the linear s-parameter over a 19 MHz range in the indicated band at the specified temperature.
6. Data is the integrated value of the linear s-parameter over 5 MHz range at the specified temperature.
7. An external impedance matching network with ±3 % tolerance will be necessary to achieve the stated specifications.
8. This is the optimum impedance in order to achieve the performance shown.

Evaluation Board – 885136-EVB

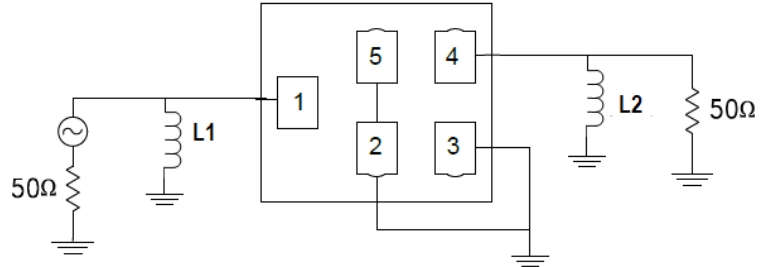
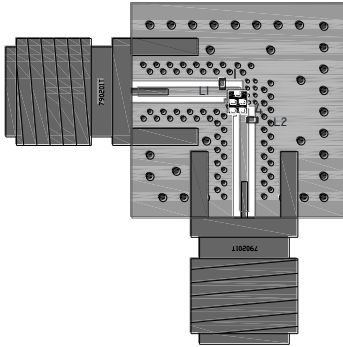

Notes:

1. Matching component values shown are for the specified Qorvo evaluation board. Value adjustment may be required in end user product circuits depending on component manufacturer and PCB material.
2. Top, middle & bottom layers: 1 oz. copper. Substrates: FR4 dielectric 0.31" thick. Finish plating: Nickel: 3-8 μm thick, Gold: 0.03-0.2 μm thick. Hole plating: Copper min .0008 μm thick.

Bill of Material – 885136-EVB

Reference Des.	Value	Description	Manuf.	Part Number
U1	-	2437 MHz BAW Filter	Qorvo	885136
L1	15nH	0201 chip Inductor, $\pm 3\%$	Murata	LQP03TN15NH02
L2	15nH	0201 chip Inductor, $\pm 3\%$	Murata	LQP03TN15NH02
SMA	-	SMA connector	Radiall	9602-1111-018
PCB	-	3-layer	Qorvo	961094-04

PCB Mounting Pattern

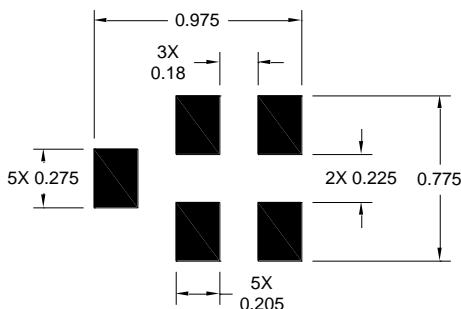

Notes:

1. All dimensions are in millimeters. Angles are in degrees.
2. This drawing specifies the mounting pattern used on the Qorvo evaluation board for this product. Some modification may be necessary to suit end user assembly materials and processes.

Performance Plots

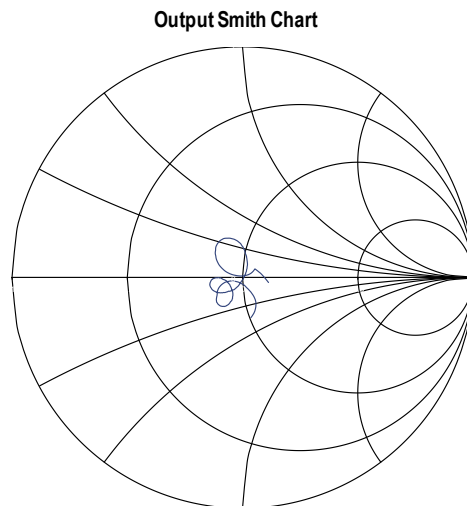
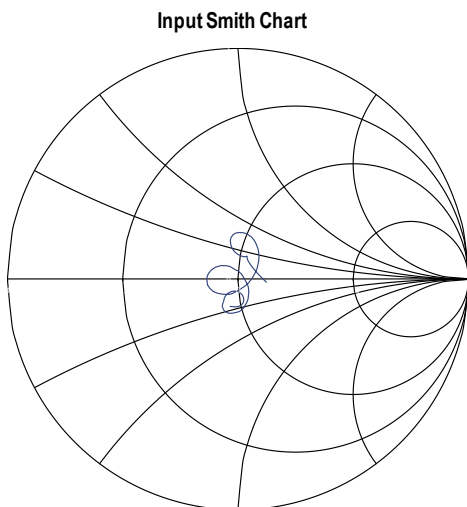
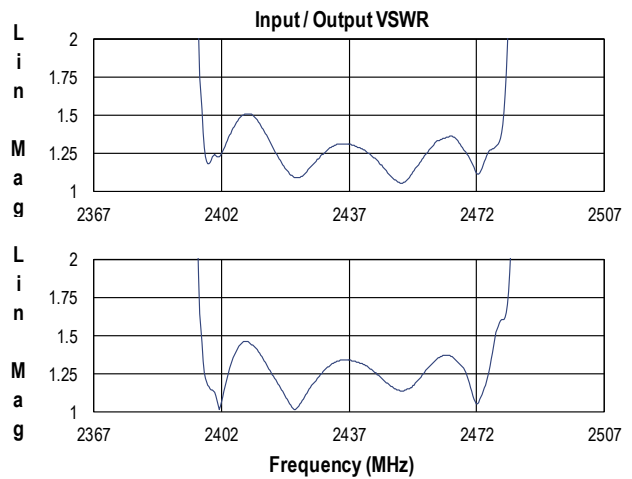
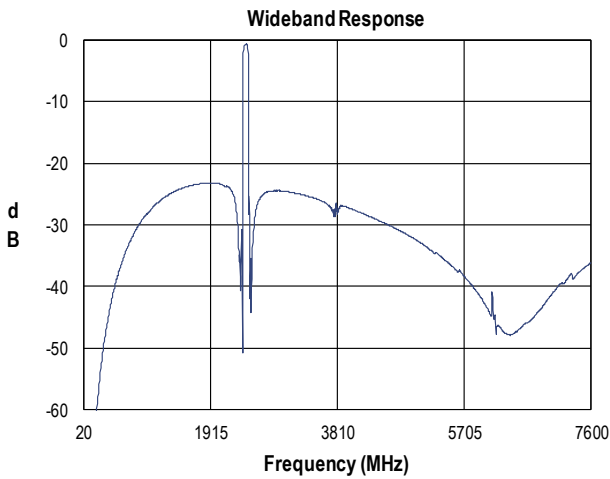
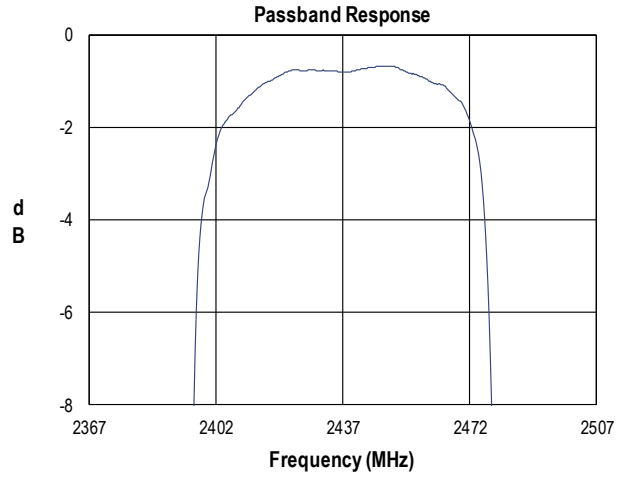
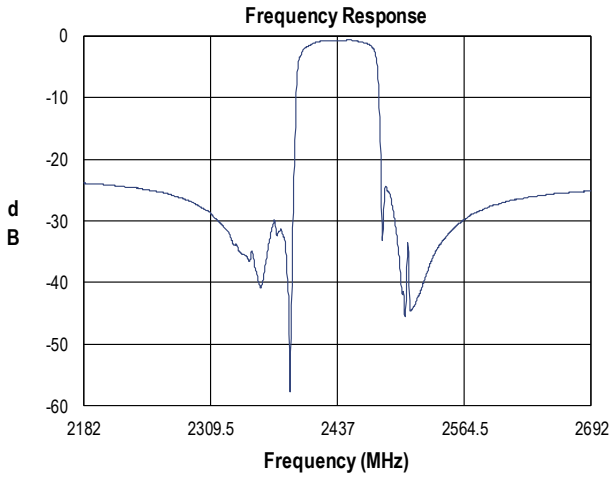

Package Information

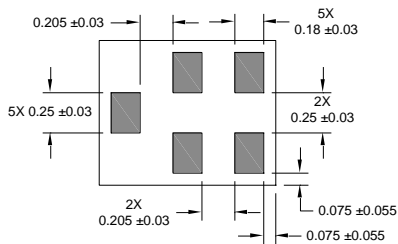
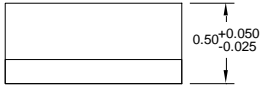
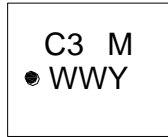

Package Style: ULC1109A
Dimensions: 1.1 x 0.9 x 0.50 mm

Package for Surface Mount Technology
Terminations: Au plating 0.5 - 1.0µm, over a 2- 6µm Ni Plating
Approximate weight 1.37mg

The date code consists of: M = manufacturing site code WW = 2 digit week and Y = last digit of year.

Notes:

1. All dimensions shown are typical in millimeters.
2. An asterisk (*) in front of the marking code indicates prototype.

Tape and Reel information

Standard T/R size = 15,000 units/reel. All dimensions are in millimeters

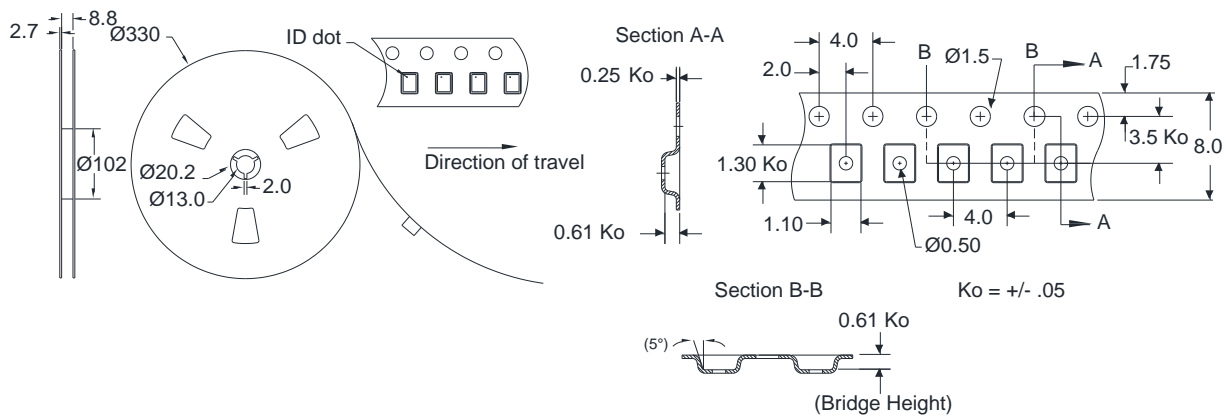

Handling Precautions

Parameter	Rating	Standard
ESD – Human Body Model (HBM)	Class 1C	ESDA / JEDEC JS-001
ESD – Charge Device Model (CDM)	Class C3	ESDA/JEDEC JS-002
MSL – Moisture Sensitivity Level	Level 3	JEDEC Standard IPC/JEDEC J-STD-020



Caution!
ESD-Sensitive Device

Solderability

Compatible with both lead-free (260°C max. reflow temp.) and tin/lead (245°C max. reflow temp.) soldering processes. Solder profiles available upon request.

Refer to [Soldering Profile](#) for recommended guidelines

RoHS Compliance

This part is compliant with 2011/65/EU RoHS directive (Restrictions on the Use of Certain Hazardous Substances in Electrical and Electronic Equipment) as amended by Directive 2015/863/EU. This product also has the following attributes:

- Lead Free
- Halogen Free (Chlorine, Bromine)
- Antimony Free
- TBBP-A (C₁₅H₁₂Br₄O₂) Free
- PFOS Free
- SVHC Free
- Qorvo Green

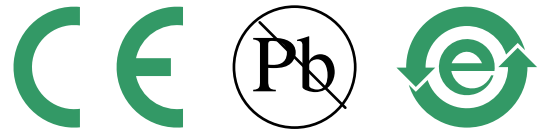

Contact Information

For the latest specifications, additional product information, worldwide sales and distribution locations:

Web: www.qorvo.com

Tel: 1-844-890-8163

Email: customer.support@qorvo.com

For technical questions and application information: Email: fapplication.engineering@qorvo.com

Important Notice

The information contained herein is believed to be reliable; however, Qorvo makes no warranties regarding the information contained herein and assumes no responsibility or liability whatsoever for the use of the information contained herein. All information contained herein is subject to change without notice. Customers should obtain and verify the latest relevant information before placing orders for Qorvo products. The information contained herein or any use of such information does not grant, explicitly or implicitly, to any party any patent rights, licenses, or any other intellectual property rights, whether with regard to such information itself or anything described by such information. **THIS INFORMATION DOES NOT CONSTITUTE A WARRANTY WITH RESPECT TO THE PRODUCTS DESCRIBED HEREIN, AND QORVO HEREBY DISCLAIMS ANY AND ALL WARRANTIES WITH RESPECT TO SUCH PRODUCTS WHETHER EXPRESS OR IMPLIED BY LAW, COURSE OF DEALING, COURSE OF PERFORMANCE, USAGE OF TRADE OR OTHERWISE, INCLUDING THE IMPLIED WARRANTIES OF MERCHANTABILITY AND FITNESS FOR A PARTICULAR PURPOSE.**

Without limiting the generality of the foregoing, Qorvo products are not warranted or authorized for use as critical components in medical, life-saving, or life-sustaining applications, or other applications where a failure would reasonably be expected to cause severe personal injury or death.

Copyright 2016 © Qorvo, Inc. | Qorvo is a registered trademark of Qorvo, Inc.

X-ON Electronics

Largest Supplier of Electrical and Electronic Components

Click to view similar products for [Signal Conditioning](#) category:

Click to view products by [Qorvo](#) manufacturer:

Other Similar products are found below :

[MAPDCC0001](#) [MAPDCC0004](#) [PD0409J5050S2HF](#) [880157](#) [HHS-109-PIN](#) [DC1417J5005AHF](#) [AFS14A30-2185.00-T3](#) [AFS14A35-1591.50-T3](#) [DS-323-PIN](#) [B39321R801H210](#) [1A0220-3](#) [JP510S](#) [LFB212G45SG8C341](#) [LFB322G45SN1A504](#) [LFL182G45TC3B746](#) [SF2159E](#) [30057](#) [FM-104-PIN](#) [CER0813B](#) [MAPDCC0005](#) [3A325](#) [40287](#) [41180](#) [ATB3225-75032NCT](#) [BD0810N50100AHF](#) [BD2425J50200AHF](#) [C5060J5003AHF](#) [JHS-115-PIN](#) [JP503AS](#) [DC0710J5005AHF](#) [DC2327J5005AHF](#) [DC3338J5005AHF](#) [43020](#) [LFB2H2G60BB1C106](#) [LFL15869MTC1B787](#) [X3C19F1-20S](#) [XC3500P-20S](#) [10013-20](#) [SF2194E](#) [CDBLB455KCAX39-B0](#) [TGL2208-SM, EVAL](#) [RF1353C](#) [1E1305-3](#) [1F1304-3S](#) [1G1304-30](#) [B0922J7575AHF](#) [2020-6622-20](#) [10017-3](#) [TP-103-PIN](#) [BD1222J50200AHF](#)