

Features

- ▶ Ultra low noise performance
- ▶ High linearity
- ▶ All positive supply voltages
- ▶ Pb-free RoHs compliant 4x4 QFN package

Description

The CMD163C4 is a high dynamic range GaAs MMIC low noise amplifier housed in a leadless 4x4 mm surface mount package. The CMD163C4 is ideally suited for military, space and communications systems where small size and high linearity are needed. The device is optimized for 21 GHz and delivers greater than 23 dB of gain with a corresponding output 1 dB compression point of +18 dBm and noise figure of 1.7 dB. The CMD163C4 is a 50 ohm matched design which eliminates the need for external DC blocks and RF port matching.

Functional Block Diagram

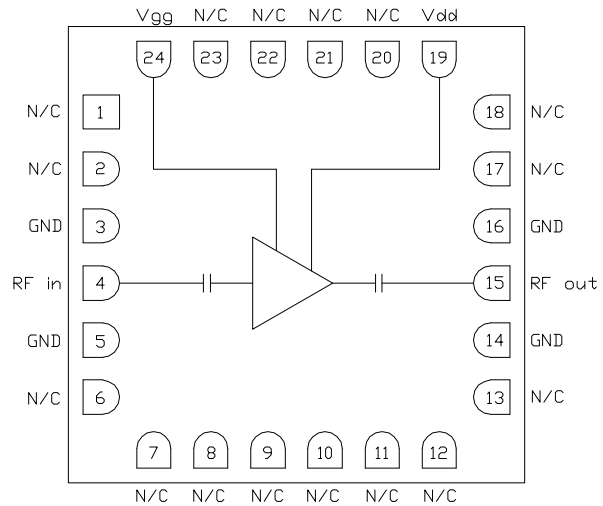

Electrical Performance - $V_{dd} = 4.0\text{ V}$, $V_{gg} = 3.0\text{ V}$, $T_A = 25\text{ }^\circ\text{C}$, $F=21\text{ GHz}$

Parameter	Min	Typ	Max	Units
Frequency Range	17 - 27			GHz
Gain		23		dB
Noise Figure		1.7		dB
Input Return Loss		10		dB
Output Return Loss		11		dB
Output P1dB		17.5		dBm
Supply Current		120		mA



CMD163C4

17-27 GHz Low Noise Amplifier

Specifications

Absolute Maximum Ratings

Parameter	Rating
Drain Voltage, V _{dd}	4.5 V
Gate Voltage, V _{gg}	4.0 V
RF Input Power	+20 dBm
Channel Temperature, T _{ch}	150 °C
Power Dissipation, P _{diss}	600 mW
Thermal Resistance	108 °C/W
Operating Temperature	-40 to 85 °C
Storage Temperature	-55 to 150 °C

Operation of this device outside the maximum ratings may cause permanent damage.

Recommended Operating Conditions

Parameter	Min	Typ	Max	Units
V _{dd}	2.0	4.0	4.25	V
I _{dd}		120		mA
V _{gg}	0	3.0	4.0	V

Electrical performance is measured at specific test conditions. Electrical specifications are not guaranteed over all recommended operating conditions.

Electrical Specifications, V_{dd} = 4.0 V, V_{gg} = 3.0 V, T_A = 25 °C

Parameter	Min	Typ	Max	Min	Typ	Max	Units
Frequency Range	17 - 27			17.7 - 23.6			GHz
Gain	17	23	27	19	23	27	dB
Noise Figure		1.8	2.8		1.8	2.3	dB
Input Return Loss		8			10		dB
Output Return Loss		12			12		dB
Output P1dB		18			18		dBm
Output IP3		25			25		dBm
Supply Current	70	120	150	70	120	150	mA
Gain Temperature Coefficient		0.015			0.015		dB/°C
Noise Figure Temperature Coefficient		0.01			0.01		dB/°C

ver 1.3 1017

Typical Performance

Broadband Performance, $V_{dd} = 4.0\text{ V}$, $V_{gg} = 3.0\text{ V}$, $I_{dd} = 120\text{ mA}$, $T_A = 25\text{ }^\circ\text{C}$

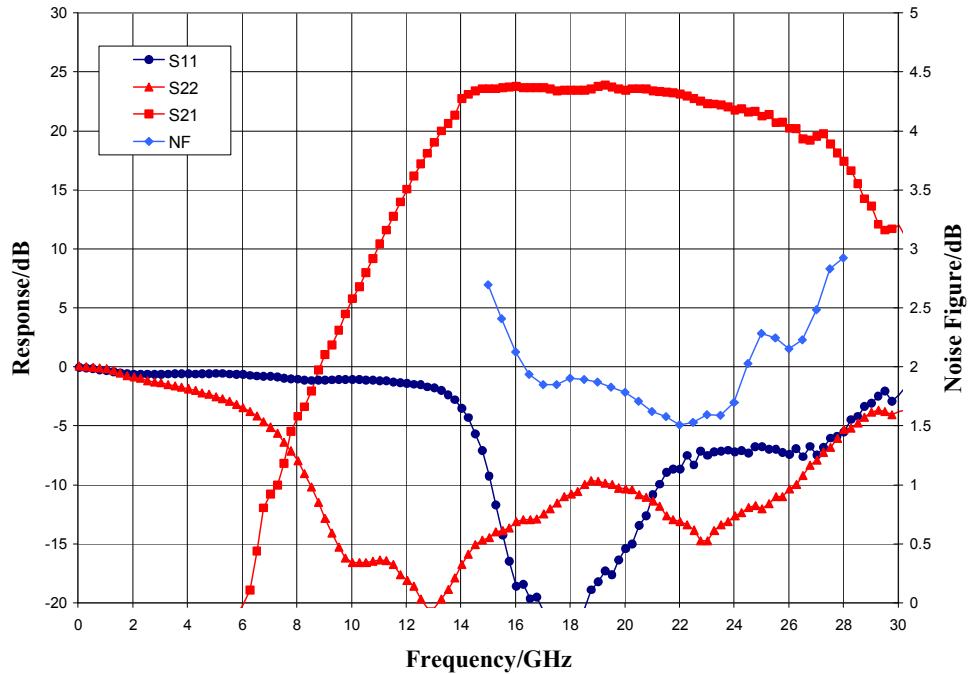

Narrow-band Performance, $V_{dd} = 4.0\text{ V}$, $V_{gg} = 3.0\text{ V}$, $I_{dd} = 120\text{ mA}$, $T_A = 25\text{ }^\circ\text{C}$

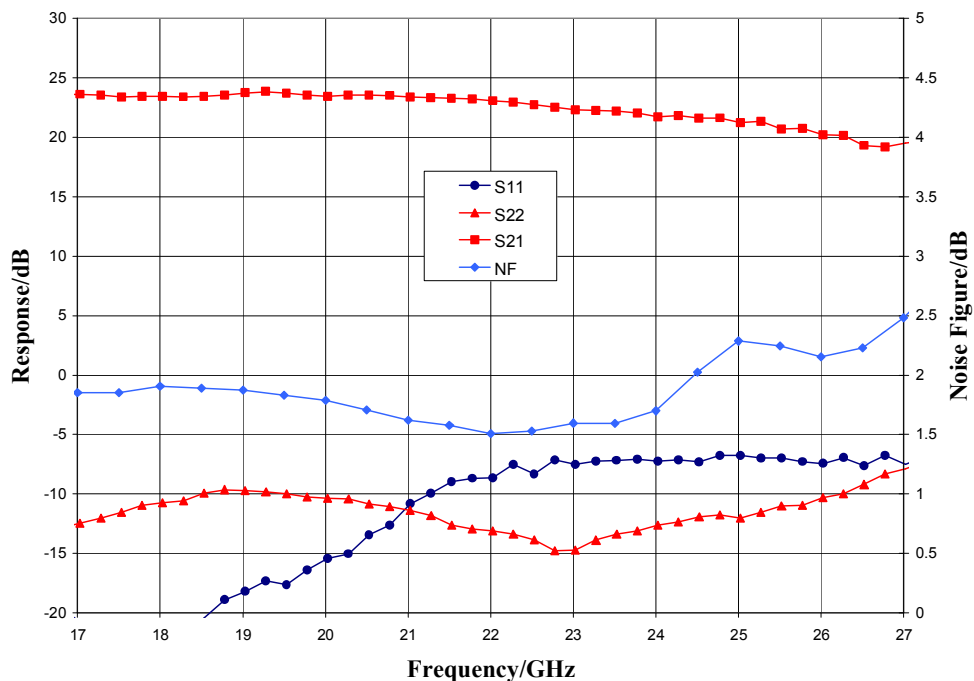

ver 1.3 1017

Typical Performance

Gain vs. Temperature, $V_{dd} = 4.0\text{ V}$, $V_{gg} = 3.0\text{ V}$

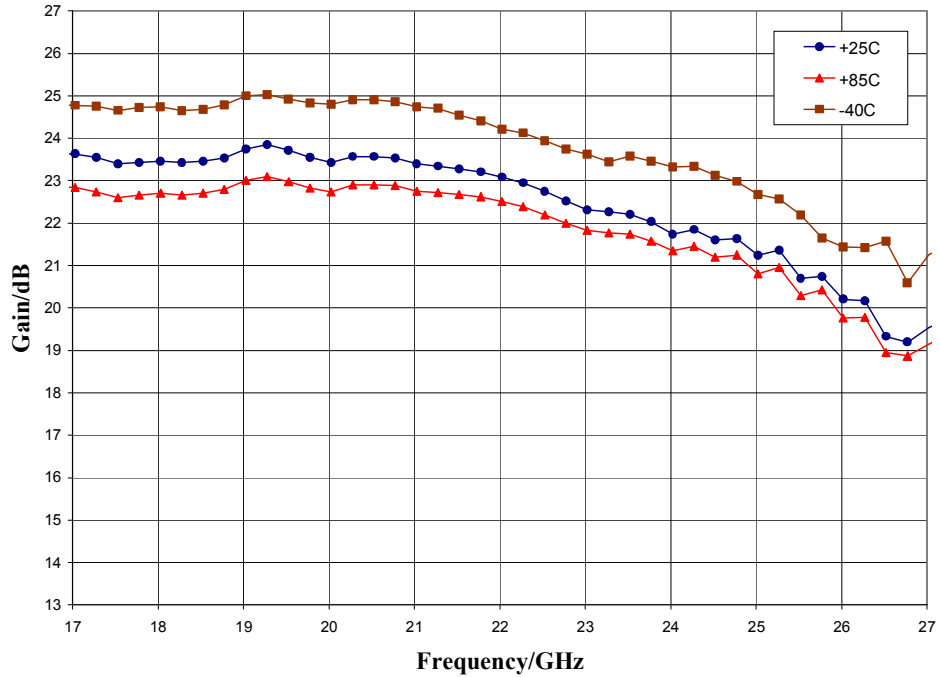

Noise Figure vs. Temperature, $V_{dd} = 4.0\text{ V}$, $V_{gg} = 3.0\text{ V}$

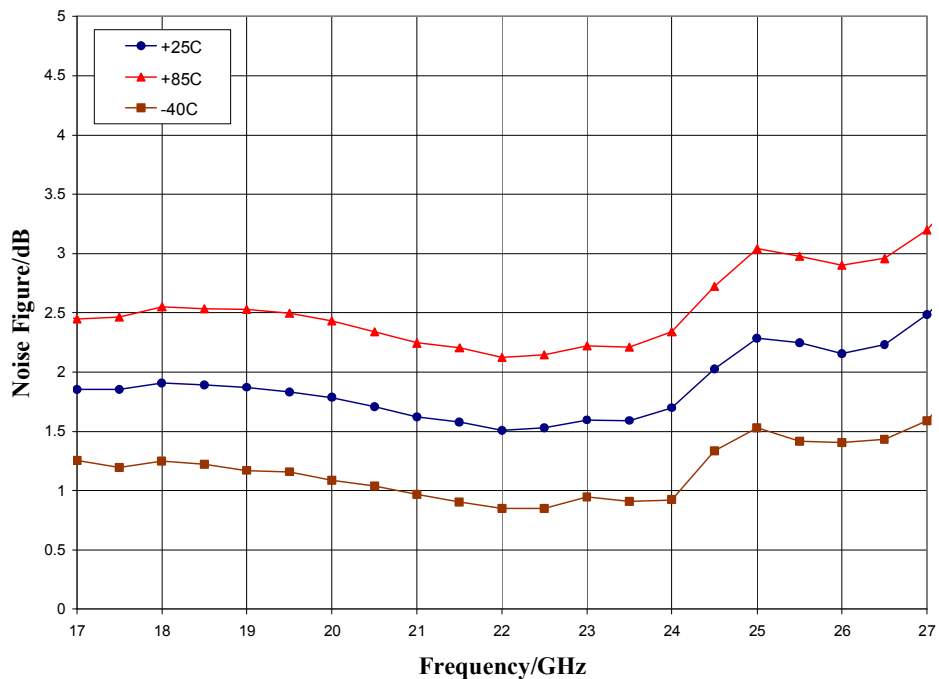

ver 1.3 1017

Typical Performance

Output Power, $V_{dd} = 4.0\text{ V}$, $V_{gg} = 3.0\text{ V}$, $T_A = 25\text{ }^\circ\text{C}$

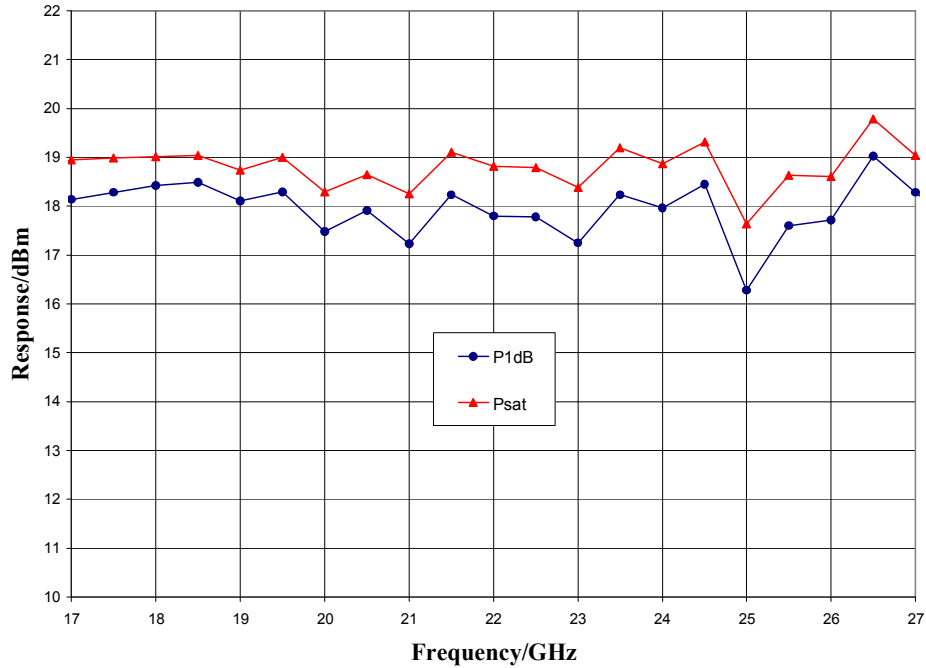

P1dB vs. Temperature, $V_{dd} = 4.0\text{ V}$, $V_{gg} = 3.0\text{ V}$

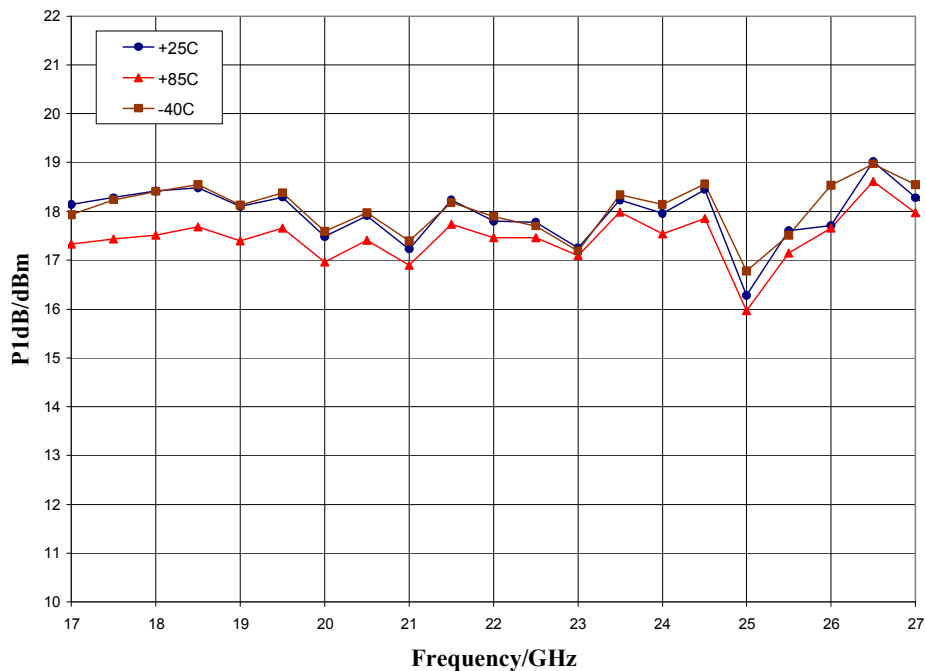

ver 1.3 1017

Typical Performance

Output IP3 vs. Temperature, $V_{dd} = 4.0\text{ V}$, $V_{gg} = 3.0\text{ V}$

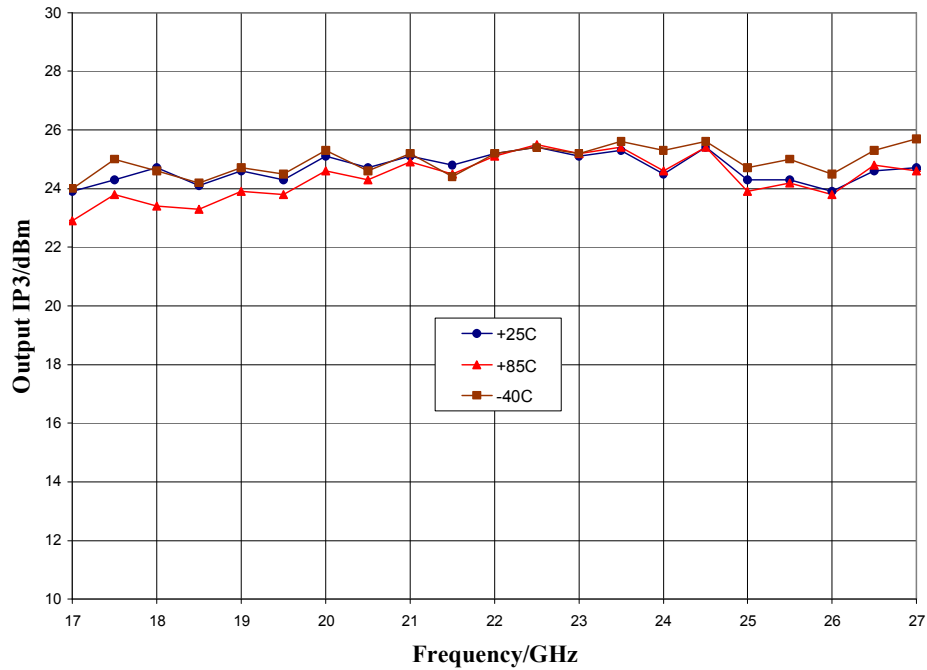

Mechanical Information

Package Information and Dimensions

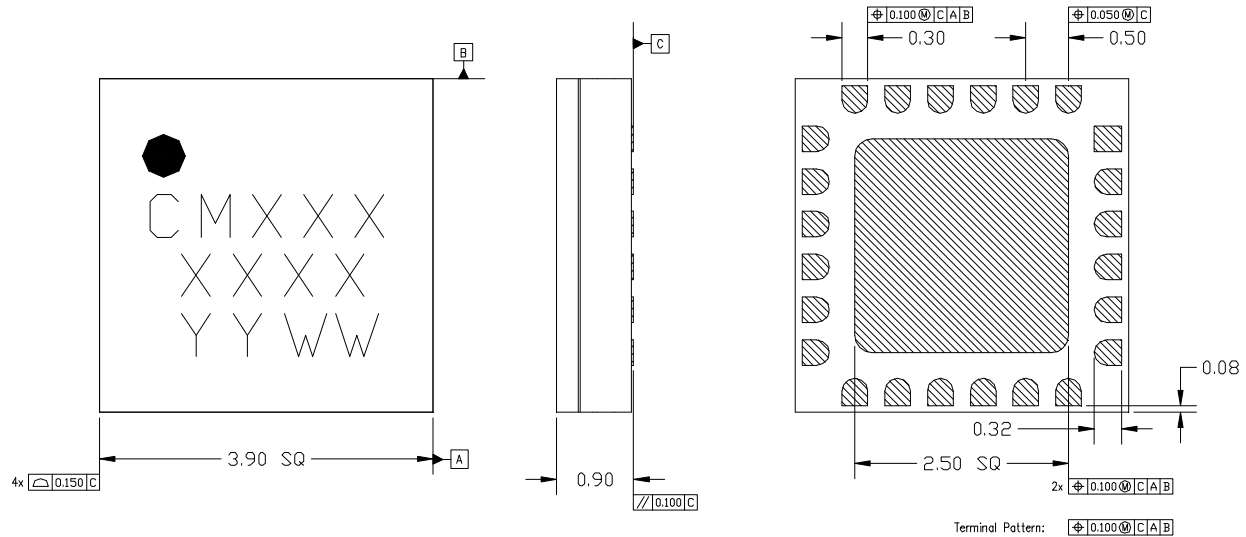

- NOTES:
1. ALL DIMENSIONS SHOWN IN mm.
 2. MATERIAL: BLACK ALUMINA
 3. LEAD FINISH:
 - 3.1. Ni: 8.89um MAX, 1.27um MIN
 - 3.2. Pd: 0.17um MAX, 0.07um MIN
 - 3.3. Au: 0.254um MAX, 0.03um MIN
 4. MARKING
 - 4.1. LINE 1: PART NUMBER
 - 4.1.1. EXAMPLE: CMD163C4 SHALL BE MARKED AS CM191
 - 4.2. LINE 2: LOT NUMBER
 - 4.3. LINE 3: DATE CODE - LAST 2 DIGITS OF THE YEAR OF MANUFACTURE FOLLOWED BY A 2 DIGIT WEEK CODE
 5. ALTERNATE PIN #1 IDENTIFIER IS A SINGLE SQUARE PAD
 6. ALTERNATE DIE PADDLE MAY HAVE CHAMFERED CORNERS

Recommended PCB Land Pattern

Custom MMIC Design Services recommends that the user develop the land pattern that will provide the best design for proper solder reflow and device attach for their specific application. Please review Custom MMIC Application Note AN 105 for a recommended land pattern approach.



Recommended Solder Reflow Profile

Custom MMIC Design Services recommends screen printing with belt furnace reflow to ensure proper solder reflow and device attach. Please review Custom MMIC Application Note AN 102 for a recommended solder reflow profile.

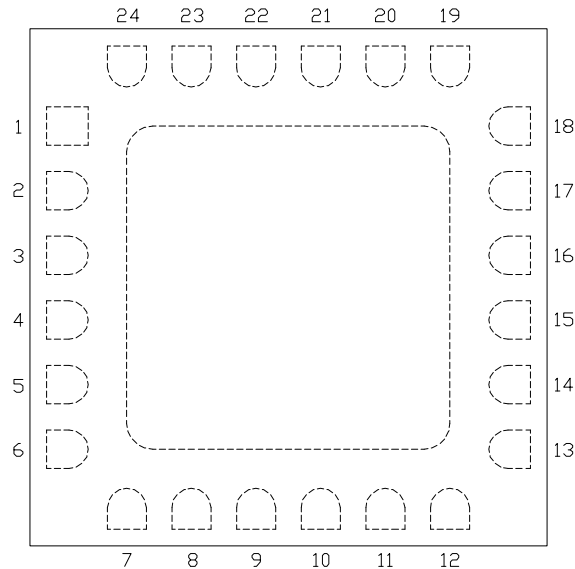
Pin Description

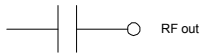
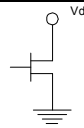
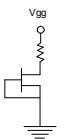

Functional Description

Pin	Function	Description	Schematic
1, 2, 6-13, 17, 18, 20-23	N/C	No connection required. These pins may be connected to RF/DC ground	
3, 5, 14, 16 and die paddle	Ground	Connect to RF/DC ground	
4	RF in	DC blocked and 50 ohm matched	
15	RF out	DC blocked and 50 ohm matched	
19	Vdd	Power supply voltage Decoupling and bypass caps required	
24	Vgg	Power supply voltage Decoupling and bypass caps required	

Applications Information

Application Circuit

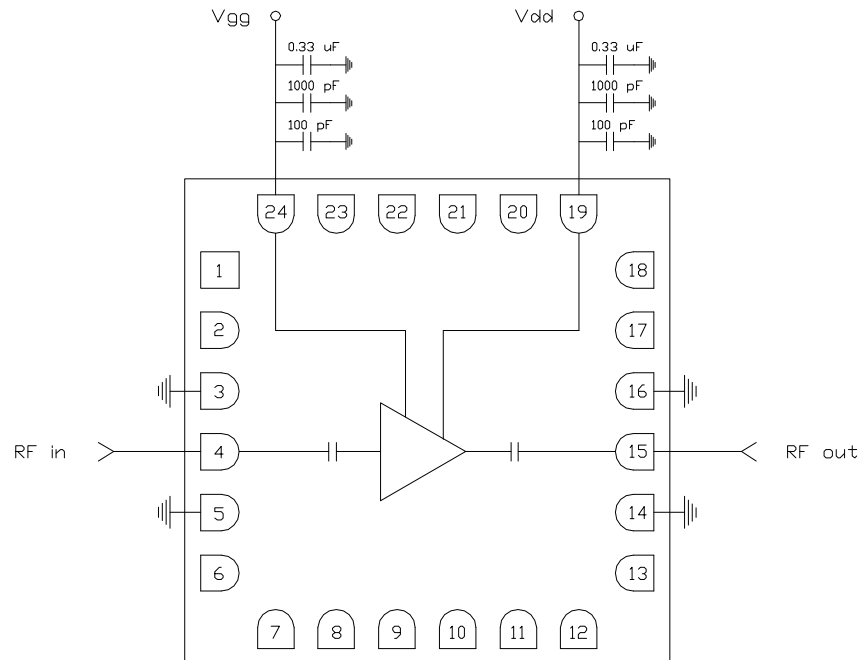

Biasing and Operation

The CMD163C4 is biased with a positive drain supply and positive gate supply. Performance is optimized when the drain voltage is set to +4.0 V, though it may be set to a minimum of +2.0 V and a maximum of +4.25 V. The recommended gate voltage is +3.0 V.

Turn ON procedure:

1. Apply drain voltage V_{dd} and set to +4 V
2. Apply gate voltage V_{gg} and set to +3 V

Turn OFF procedure:

1. Turn off gate voltage V_{gg}
2. Turn off drain voltage V_{dd}

RF power can be applied at any time.

GaAs MMIC devices are susceptible to damage from Electrostatic Discharge. Proper precautions should be observed during handling, assembly and test.

ver 1.3 1017

Applications Information

Evaluation Board

The circuit board shown has been developed for optimized assembly at Custom MMIC. A sufficient number of via holes should be used to connect the top and bottom ground planes. As surface mount processes vary, careful process development is recommended.

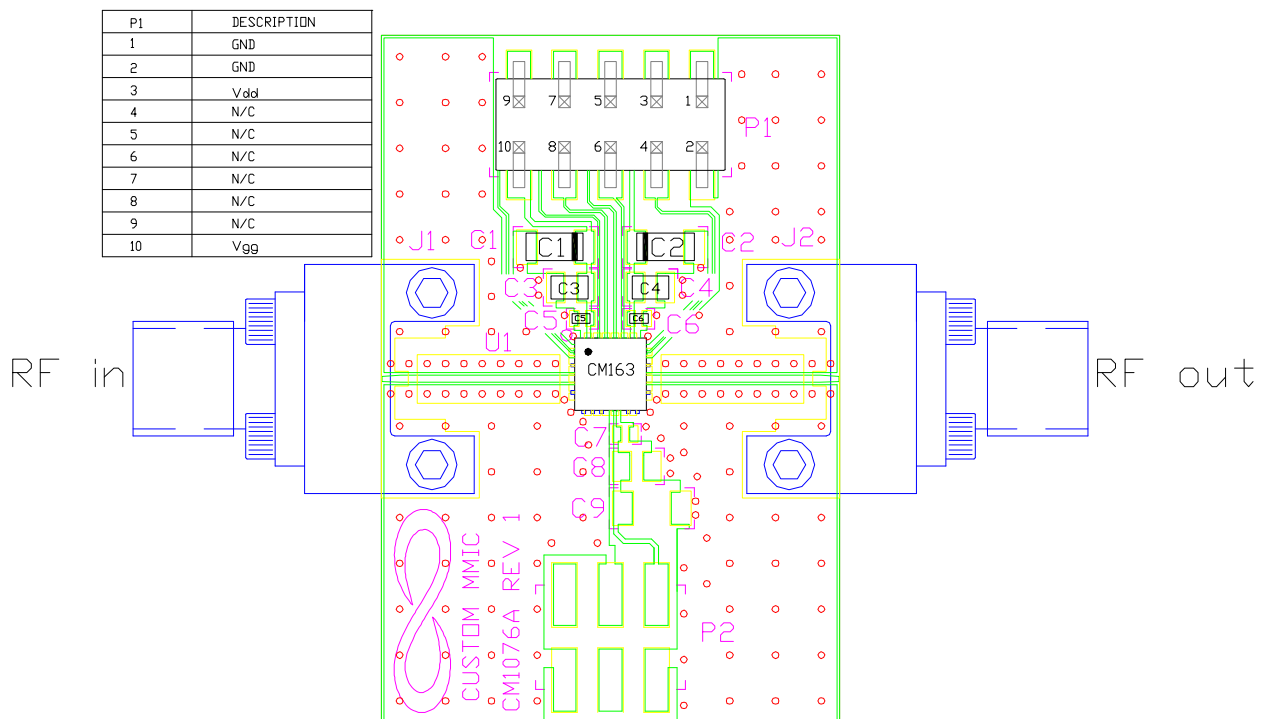

Designator	Value	Description
J1, J2		SMA End Launch Connector
P1		10 Pin Header
C1, C2	0.33 μ F	Capacitor, Tantalum
C3, C4	1000 pF	Capacitor, 0603
C5, C6	100 pF	Capacitor, 0402
U1		CMD163C4 Low Noise Amplifier
PCB		CM1076A Evaluation PCB

ver 1.3 1017

X-ON Electronics

Largest Supplier of Electrical and Electronic Components

Click to view similar products for [RF Amplifier](#) category:

Click to view products by [Qorvo](#) manufacturer:

Other Similar products are found below :

[A82-1](#) [BGA622H6820XTSA1](#) [BGA 728L7 E6327](#) [BGB719N7ESDE6327XTMA1](#) [HMC397-SX](#) [HMC405](#) [HMC561-SX](#) [HMC8120-SX](#)
[HMC8121-SX](#) [HMC-ALH382-SX](#) [HMC-ALH476-SX](#) [SE2433T-R](#) [SMA3101-TL-E](#) [SMA39](#) [A66-1](#) [A66-3](#) [A67-1](#) [LX5535LQ](#) [LX5540LL](#)
[MAAM02350](#) [HMC3653LP3BETR](#) [HMC549MS8GETR](#) [HMC-ALH435-SX](#) [SMA101](#) [SMA32](#) [SMA411](#) [SMA531](#) [SST12LP17E-XX8E](#)
[SST12LP19E-QX6E](#) [WPM0510A](#) [HMC5929LS6TR](#) [HMC5879LS7TR](#) [HMC1126](#) [HMC1087F10](#) [HMC1086](#) [HMC1016](#) [SMA1212](#)
[MAX2689EWS+T](#) [MAAMSS0041TR](#) [MAAM37000-A1G](#) [LTC6430AIUF-15#PBF](#) [CHA5115-QDG](#) [SMA70-2](#) [SMA4011](#) [A231](#) [HMC-](#)
[AUH232](#) [LX5511LQ](#) [LX5511LQ-TR](#) [HMC7441-SX](#) [HMC-ALH310](#)