

### Product Overview

The CMD172 is wideband GaAs MMIC absorptive Voltage-Variable Attenuator (VVA) die which operates from 18 to 40 GHz. The VVA uses a single DC control voltage of -3V to 0V to control RF signal levels over a 37 dB dynamic range. The CMD172 has an extremely low insertion loss of 1.6 dB and is a 50 ohm matched design which eliminates the need for RF port matching. The CMD172 offers full passivation for increased reliability and moisture protection.

### Functional Block Diagram

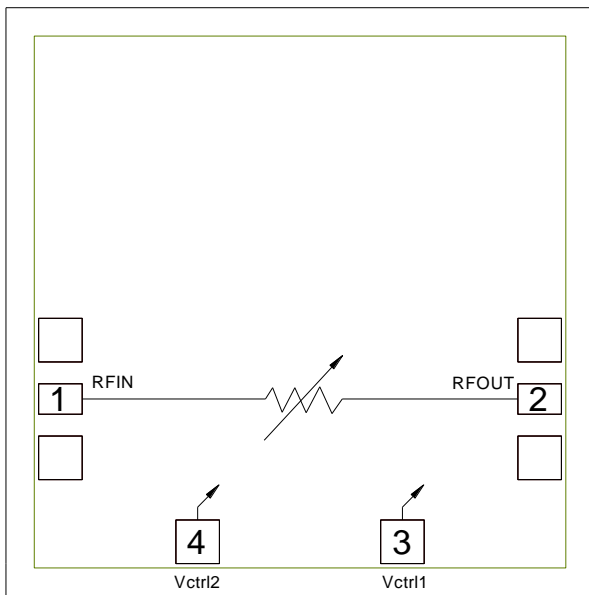

### Key Features

- Ultra Wideband Performance
- Low Insertion Loss
- Wide Attenuation Range
- Small Die Size

### Ordering Information

Part No.	Description
CMD172	50 pcs gel pack

### Electrical Performance ( $V_{ctrl} = -3.0\text{ V to }0\text{ V}$ , $T_A = 25^\circ\text{ C}$ , $F = 30\text{ GHz}$ )

Parameter	Min	Typ	Max	Units
Frequency Range		18 - 40		GHz
Insertion Loss		1.6		dB
Attenuation Range		37		dB
Input Return Loss		12		dB
Output Return Loss		12		dB
Input IP3		25		dBm

## Absolute Maximum Ratings

Parameter	Rating
Control Voltage, $V_{ctl}$	-8 V
RF Input Power (at maximum attenuation)	+25 dBm
Operating Temperature	-55 to 85° C
Storage Temperature	-55 to 150° C
Thermal Resistance, $Q_{JC}$ (maximum attenuation)	202° C/W

Exceeding any one or combination of the maximum ratings may cause permanent damage to the device.

## Recommended Operating Conditions

Parameter	Min	Typ	Max	Units
$V_{ctl}$	-5.0	-3.0	0	V

Electrical performance is measured at specific test conditions. Electrical specifications are not guaranteed over all recommended operating conditions.

## Electrical Specifications ( $V_{ctl} = -3.0$ V to 0 V, $T_A = 25^\circ$ C)

Parameter	Min	Typ	Max	Min	Typ	Max	Min	Typ	Max	Units
Frequency Range	18 - 30			30 - 35			35 - 40			GHz
Insertion Loss		1.5	2		1.8	2.5		2.2	3.3	dB
Attenuation Range	33	38		32	37		30	37		dB
Input Return Loss		12			12			10		dB
Output Return Loss		12			12			10		dB
Input IP3		27			24			22		dBm

Typical Performance

Attenuation vs. Frequency over Control Voltage,  $T_A = 25^\circ C$

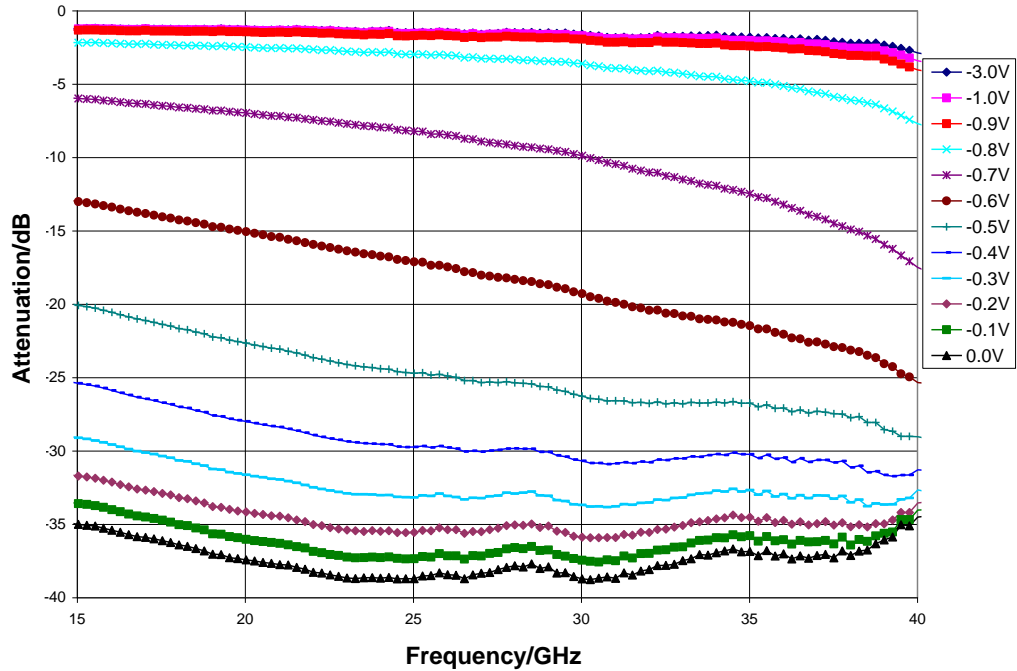

Normalized Attenuation vs. Frequency over Control Voltage,  $T_A = 25^\circ C$

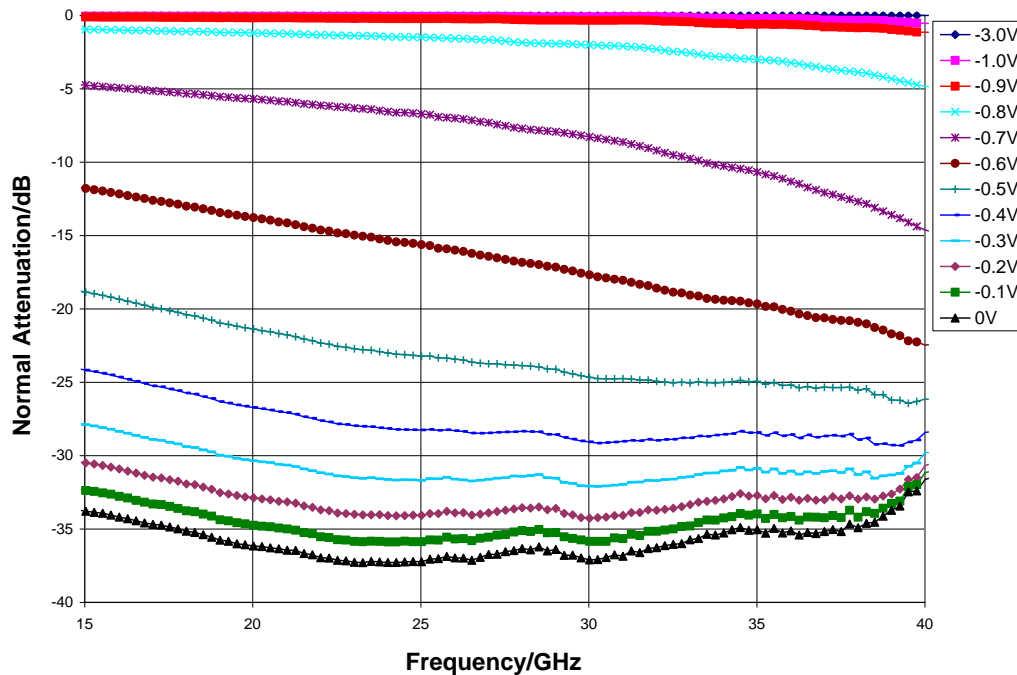

Typical Performance

Attenuation over Temperature, Insertion Loss State

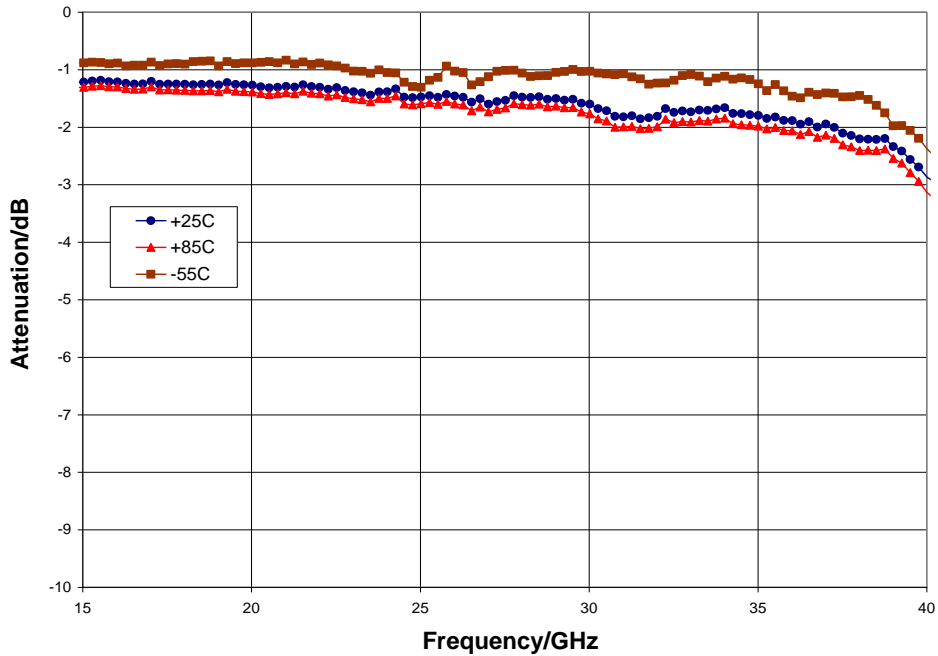

Attenuation vs. Control Voltage over Temperature @ 30 GHz

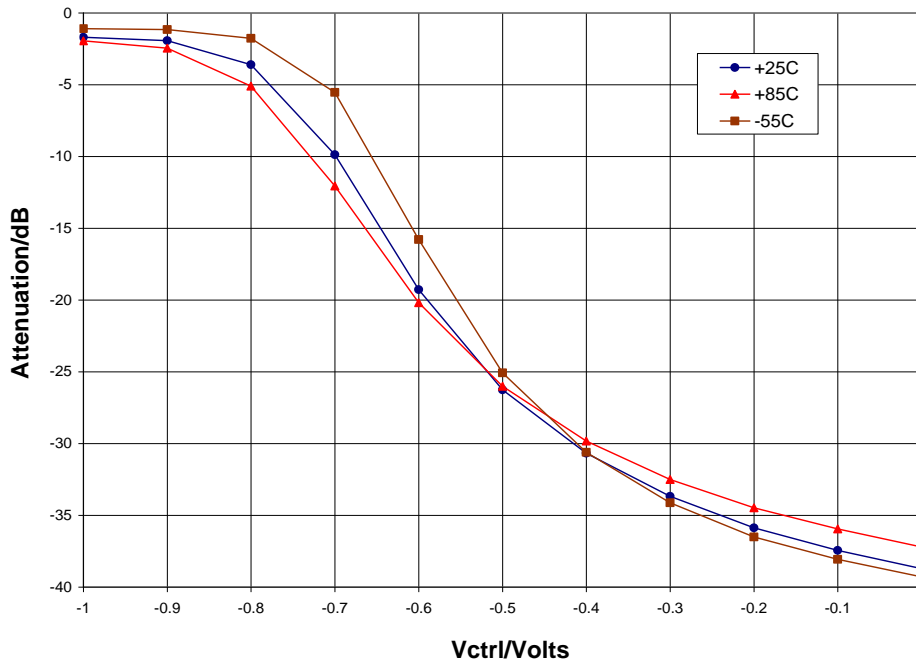

Typical Performance

Return Loss vs. Control Voltage,  $T_A = 25^\circ\text{C}$

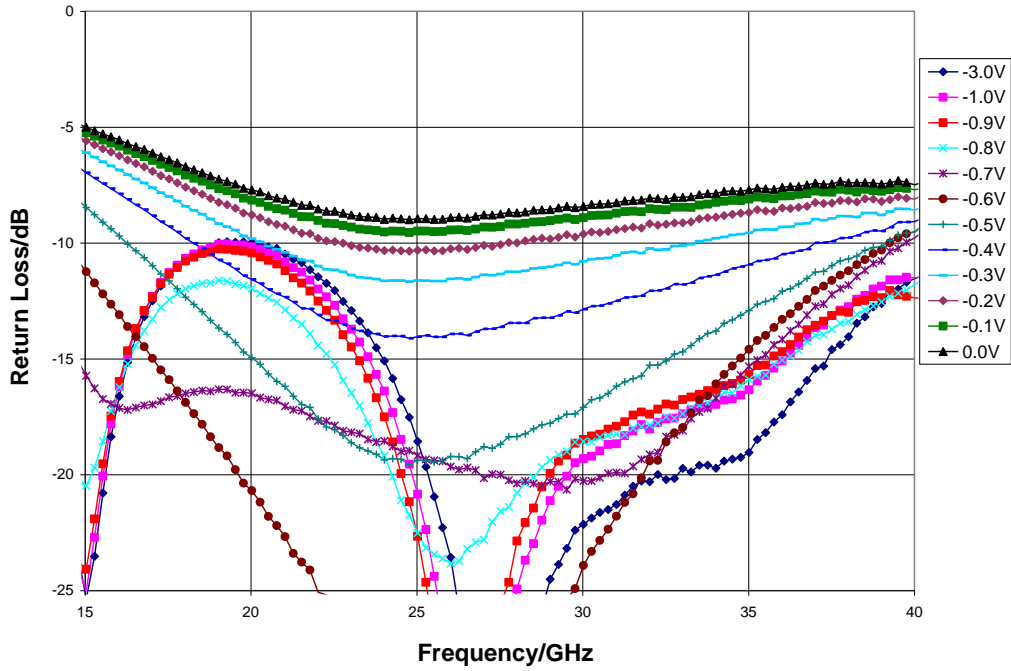

Input IP3 over Control Voltage

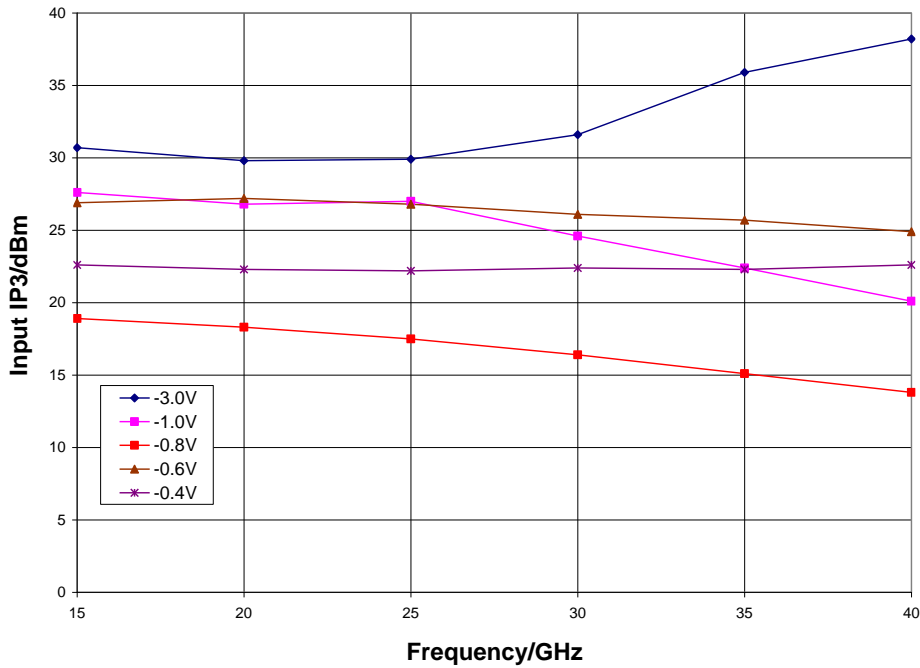

Typical Performance

Input P1dB over Control Voltage

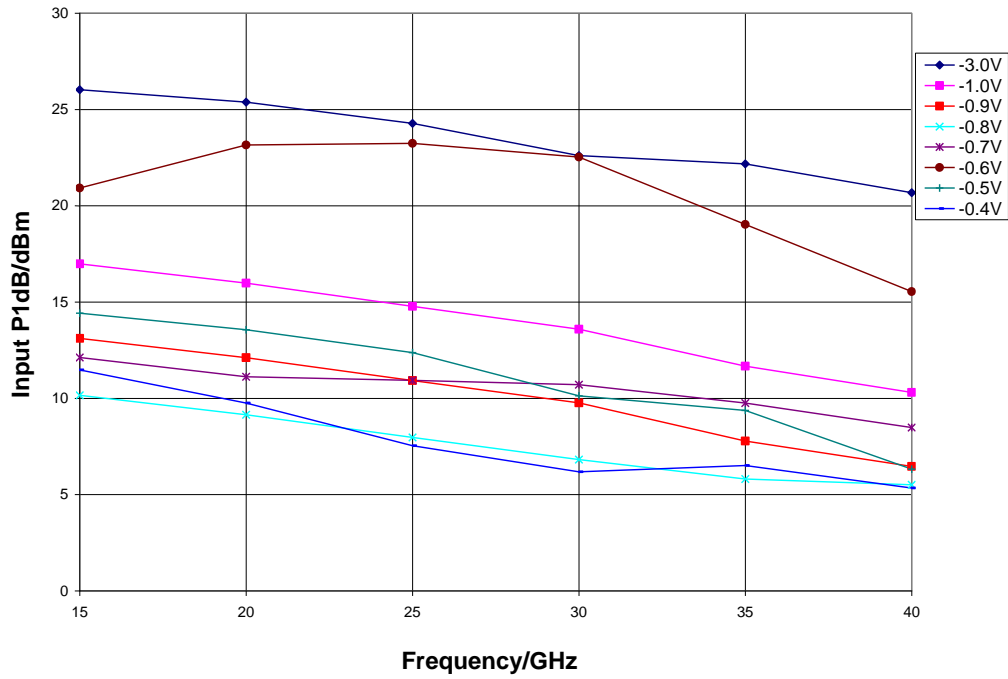

Mechanical Information

Die Outline (all dimensions in microns)

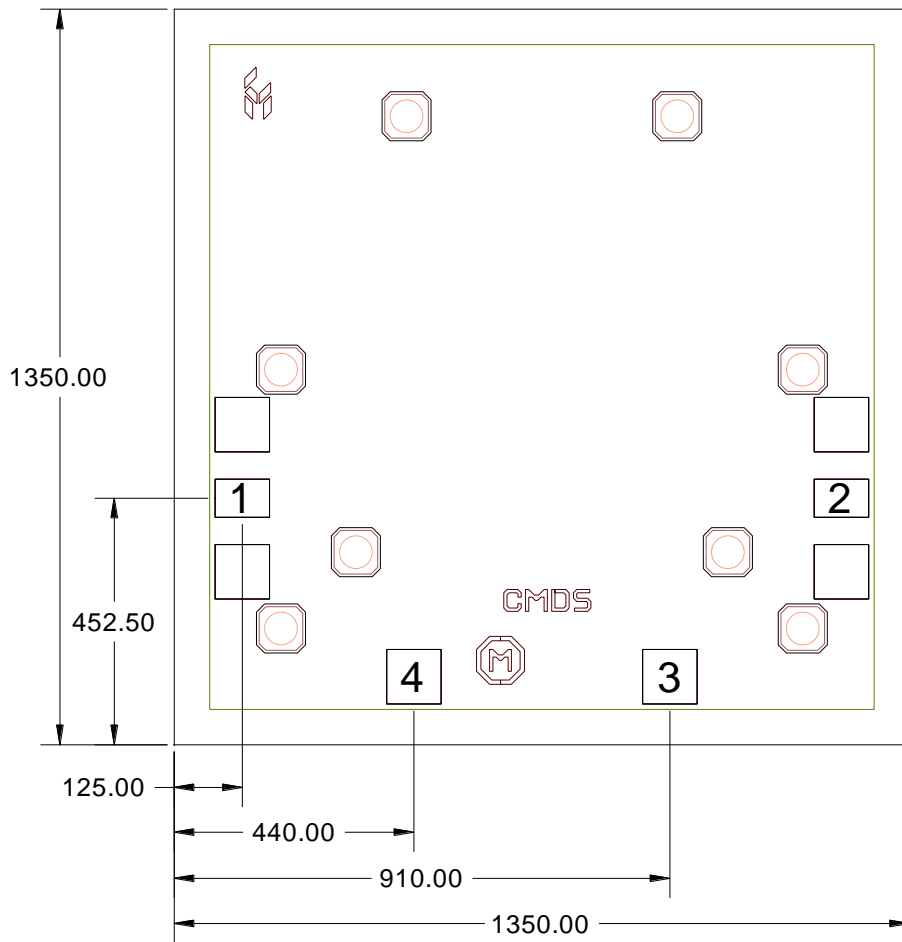

Notes:

1. No connection required for unlabeled pads
2. Backside is RF and DC ground
3. Backside and bond pad metal: Gold
4. Die is 85 microns thick
5. DC bond pads (3, 4) are 100 x 100 microns
6. RF bond pads (1, 2) are 70 x 100 microns

Pad Description

Pad Diagram

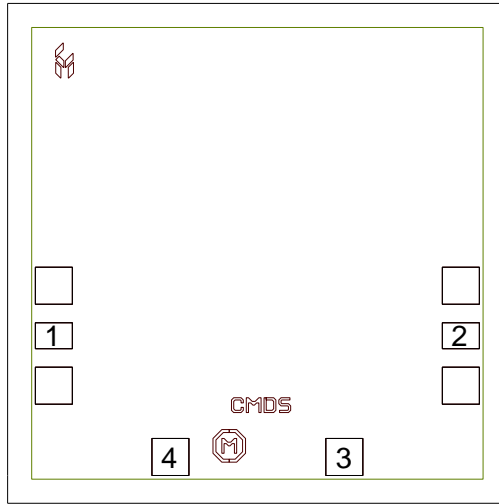

Functional Description

Pad	Function	Description	Schematic
1	RF in	DC blocked and 50 ohm matched	RF in
2	RF out	DC blocked and 50 ohm matched	RF out
3	V <sub>ctrl1</sub>	Control voltage 1	V <sub>ctrl1</sub>
4	V <sub>ctrl2</sub>	Control voltage 2	V <sub>ctrl2</sub>
Backside	Ground	Connect to RF / DC ground	



Applications Information

Assembly Guidelines

The backside of the CMD172 is RF ground. Die attach should be accomplished with electrically and thermally conductive epoxy only. Eutectic attach is not recommended. Standard assembly procedures should be followed for high frequency devices. The top surface of the semiconductor should be made planar to the adjacent RF transmission lines, and the RF decoupling capacitors placed in close proximity to the DC connections on chip.

RF connections should be made as short as possible to reduce the inductive effect of the bond wire. Use of a 0.8 mil thermosonic wedge bonding is highly recommended as the loop height will be minimized. The RF input and output require a single bond wire as shown.

The semiconductor is 85 um thick and should be handled by the sides of the die or with a custom collet. Do not make contact directly with the die surface as this will damage the monolithic circuitry. Handle with care.

Assembly Diagram

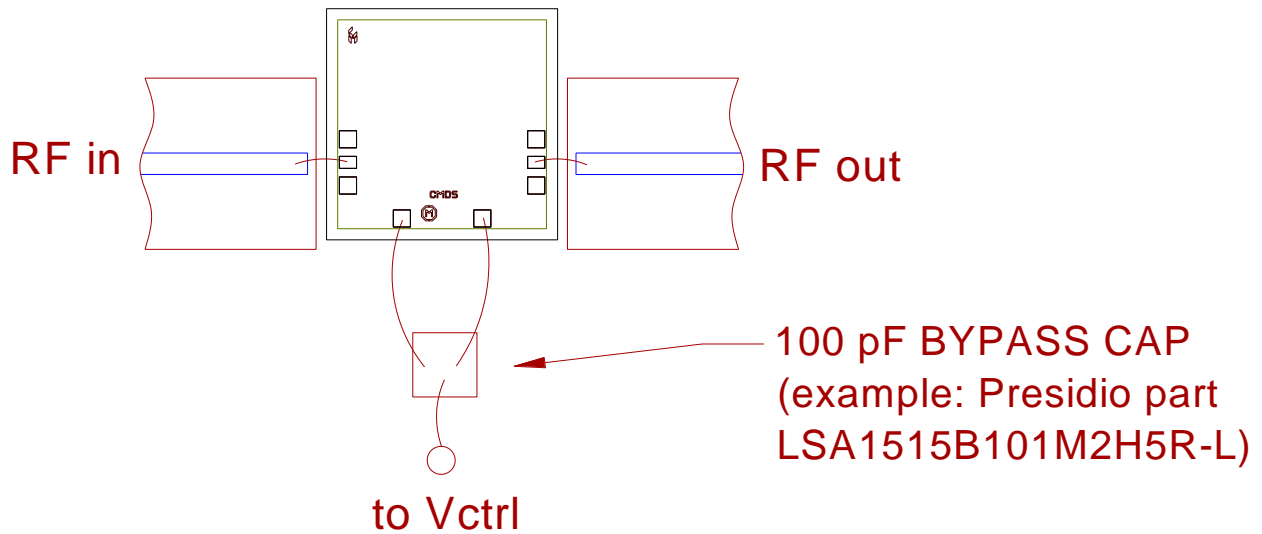

GaAs MMIC devices are susceptible to damage from Electrostatic Discharge. Proper precautions should be observed during handling, assembly and test.

## Applications Information

---

### Biasing and Operation

The CMD172 has two control voltages ( $V_{ctrl1}$  and  $V_{ctrl2}$ ) that should be connected together. Full attenuation range is achieved when  $V_{ctrl}$  is varied from -3 V to 0 V.

RF power can be applied at any time.

## RoHS Compliance

---

This part is compliant with 2011/65/EU RoHS directive (Restrictions on the Use of Certain Hazardous Substances in Electrical and Electronic Equipment) as amended by Directive 2015/863/EU.

This product also has the following attributes:

- Lead Free
- Antimony Free
- TBBP-A ( $C_{15}H_{12}Br_4O_2$ ) Free
- SVHC Free
- PFOS Free
- Halogen Free



## Important Notice

---

The information contained in this Data Sheet and any associated documents (“Data Sheet Information”) is believed to be reliable; however, Qorvo makes no warranties regarding the Data Sheet Information and assumes no responsibility or liability whatsoever for the use of said information. All Data Sheet Information is subject to change without notice. Customers should obtain and verify the latest relevant Data Sheet Information before placing orders for Qorvo® products. Data Sheet Information or the use thereof does not grant, explicitly, implicitly or otherwise any rights or licenses to any third party with respect to patents or any other intellectual property whether with regard to such Data Sheet Information itself or anything described by such information.

DATA SHEET INFORMATION DOES NOT CONSTITUTE A WARRANTY WITH RESPECT TO THE PRODUCTS DESCRIBED HEREIN, AND QORVO HEREBY DISCLAIMS ANY AND ALL WARRANTIES WITH RESPECT TO SUCH PRODUCTS WHETHER EXPRESS OR IMPLIED BY LAW, COURSE OF DEALING, COURSE OF PERFORMANCE, USAGE OF TRADE OR OTHERWISE, INCLUDING THE IMPLIED WARRANTIES OF MERCHANTABILITY AND FITNESS FOR A PARTICULAR PURPOSE. Without limiting the generality of the foregoing, Qorvo® products are not warranted or authorized for use as critical components in medical, life-saving, or life-sustaining applications, or other applications where a failure would reasonably be expected to cause severe personal injury or death. Applications described in the Data Sheet Information are for illustrative purposes only. Customers are responsible for validating that a particular product described in the Data Sheet Information is suitable for use in a particular application.

© 2020 Qorvo US, Inc. All rights reserved. This document is subject to copyright laws in various jurisdictions worldwide and may not be reproduced or distributed, in whole or in part, without the express written consent of Qorvo US, Inc. | QORVO® is a registered trademark of Qorvo US, Inc.

## X-ON Electronics

Largest Supplier of Electrical and Electronic Components

*Click to view similar products for [Attenuators](#) category:*

*Click to view products by [Qorvo](#) manufacturer:*

Other Similar products are found below :

[HMC305SLP4ETR](#) [MAAD-009195-000100](#) [TGL4201-00](#) [TGL4201-02](#) [TGL4201-03](#) [TGL4201-06](#) [TGL4201-10](#) [ATN3590-15](#) [20-50TPC](#)  
[D10AA5Z4](#) [18AH-01](#) [18AH-08](#) [ATN3580-20](#) [ATN3590-09](#) [20-50RP](#) [MASW-008322-000000](#) [MAATCC0009TR](#) [PCAF-10](#) [EXB-](#)  
[24AT9AR5X](#) [ATN3580-06](#) [ATN3580-10](#) [HMC539ALP3ETR](#) [ATN3580-02](#) [ATN3590-07](#) [SKY12408-321LF](#) [ATN3580-03](#)  
[WA04P005XBTL](#) [HMC-VVD104-SX](#) [WA04P007XCTL](#) [SKY12236-11](#) [MAATSS0018TR-3000](#) [HMC656-SX](#) [WA04P001XBTL](#) [MAAV-](#)  
[007941-TR3000](#) [WA04P004XBTL](#) [WA04P002XBTL](#) [C3A50Z4](#) [HMC941A](#) [PAT0816-C-0DB-T5](#) [PAT0816-C-8DB-T5](#) [PAT1632-C-3DB-](#)  
[T1](#) [PAT1632-C-6DB-T1](#) [PAT1632-C-10DB-T1](#) [PAT1632-C-1DB-T1](#) [PAT0816-C-2DB-T5](#) [PAT0816-C-4DB-T5](#) [DHM510-0100-006](#)  
[CMD172](#) [MAT10300](#) [MAT10180](#)