

Features

- ▶ Low conversion loss
- ▶ High isolation
- ▶ Wide IF bandwidth
- ▶ Passive double balanced topology
- ▶ Pb-free RoHs compliant 3x3 mm SMT package

Description

The CMD179C3 is a general purpose double balanced mixer in a leadless surface mount package that can be used for up- and downconverting applications between 16 and 26 GHz. The CMD179C3 has very high isolation to both the RF and IF ports due to the optimized balun structures, and can operate with an LO drive level as low as +9 dBm. The CMD179C3 can easily be configured as an image reject mixer or single sideband modulator with external hybrids and power splitters.

Functional Block Diagram

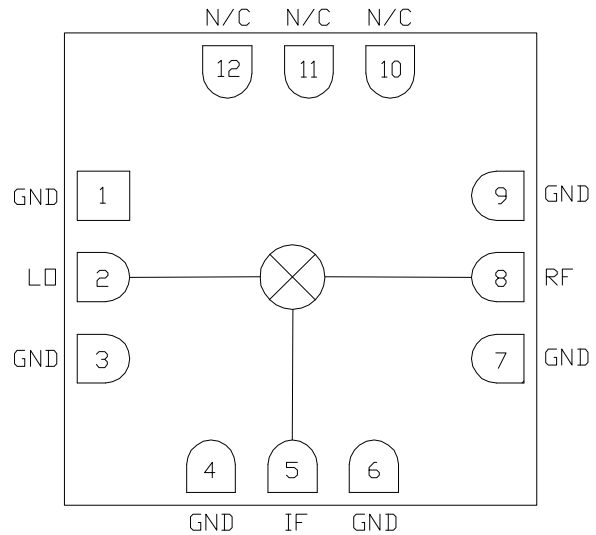

Electrical Performance - IF = 100 MHz, LO = +13 dBm, T_A = 25 °C, F = 21 GHz

Parameter	Min	Typ	Max	Units
Frequency Range, RF & LO	16 - 26			GHz
Frequency Range, IF	DC		9	GHz
Conversion Loss		6.5		dB
LO to RF Isolation		40		dB
LO to IF Isolation		48		dB
RF to IF Isolation		26		dB
Input P1dB		10		dBm

Unless otherwise noted, all measurements performed as a downconverter, IF = 100 MHz



CMD179C3

16-26 GHz Fundamental Mixer

Specifications

Absolute Maximum Ratings

Parameter	Rating
RF / IF Input Power	+25 dBm
LO Drive	+25 dBm
Operating Temperature	-40 to 85 °C
Storage Temperature	-55 to 150 °C

Operation of this device outside the maximum ratings may cause permanent damage.

Electrical Specifications - IF = 100 MHz, LO = +13 dBm, T_A = 25 °C

Parameter	Min	Typ	Max	Min	Typ	Max	Units
Frequency Range, RF & LO	18 - 24			16 - 26			GHz
Frequency Range, IF	DC		9	DC		9	GHz
Conversion Loss		6.5	8		7	10	dB
Noise Figure (SSB)		6.5	8		7	10	dB
LO to RF Isolation	37	43		36	43		dB
LO to IF Isolation	38	48		29	43		dB
RF to IF Isolation	18	25		15	25		dB
Input P1dB		10			10		dBm
Input IP3		17			17		dBm

Unless otherwise noted, all measurements performed as a downconverter, IF = 100 MHz

ver 1.6 1017

Typical Performance

Conversion Gain vs. Temperature, LO = +13 dBm, IF = 100 MHz USB

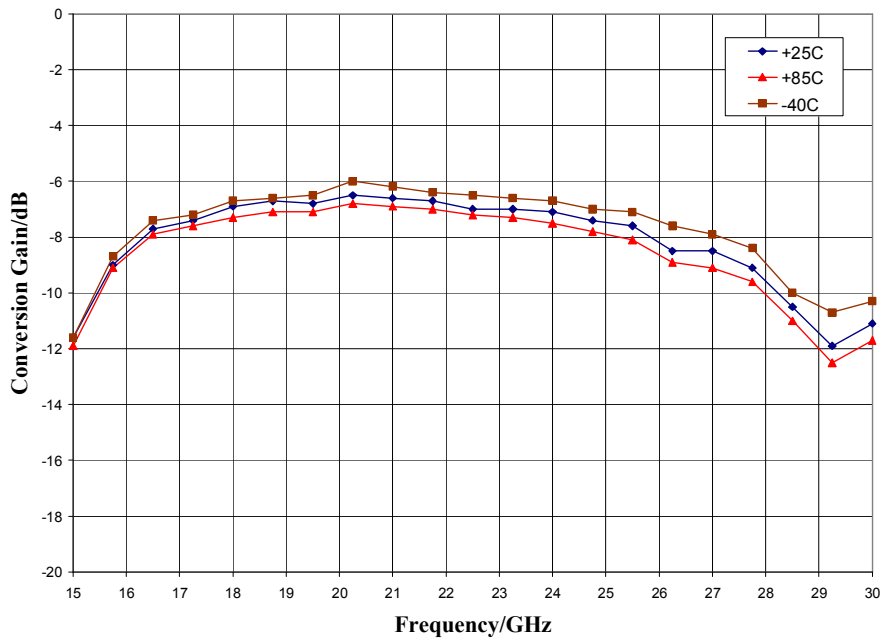

Isolation, LO = +13 dBm

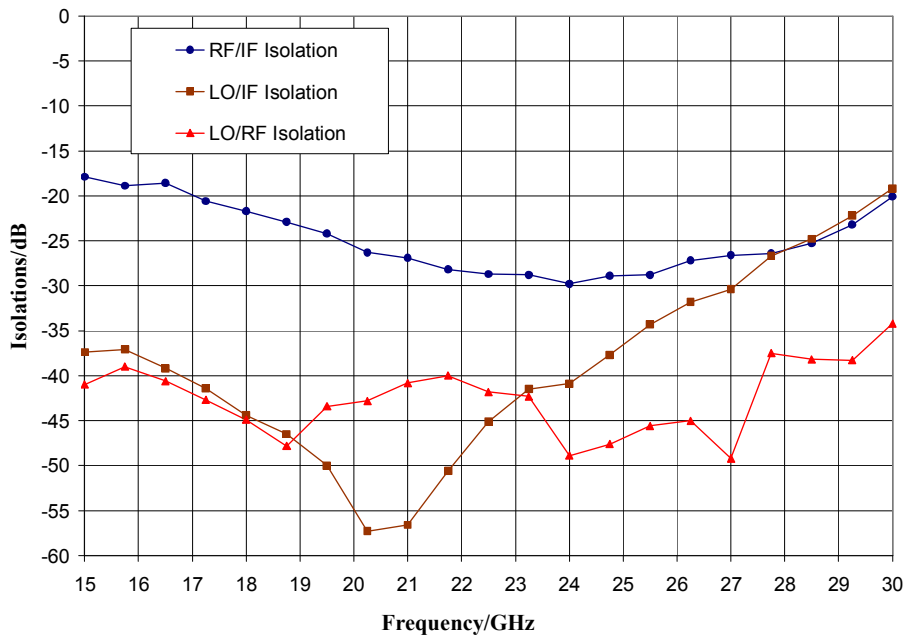

ver 1.6 1017

Typical Performance

Conversion Gain vs. LO Drive, IF = 100 MHz USB

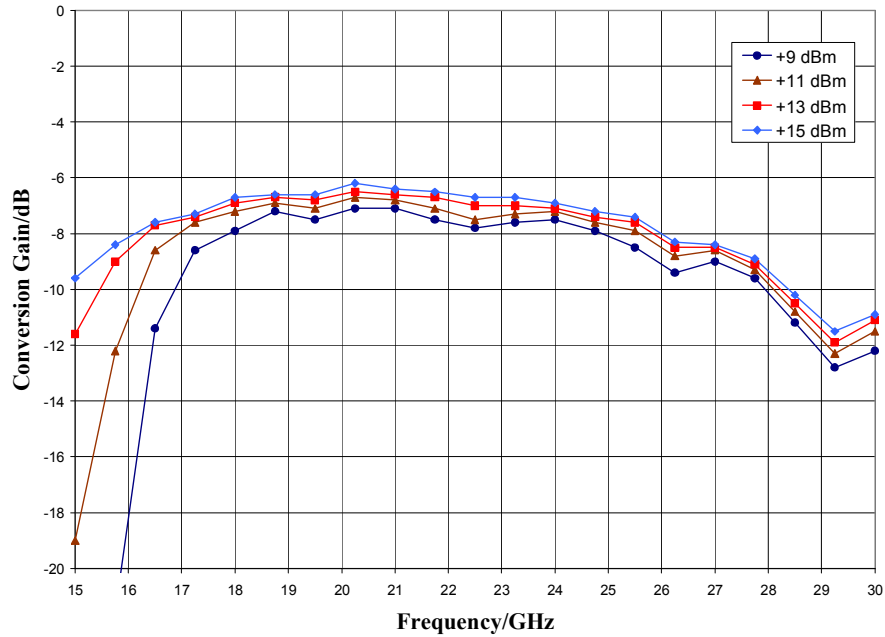

Return Loss, LO = + 13 dBm

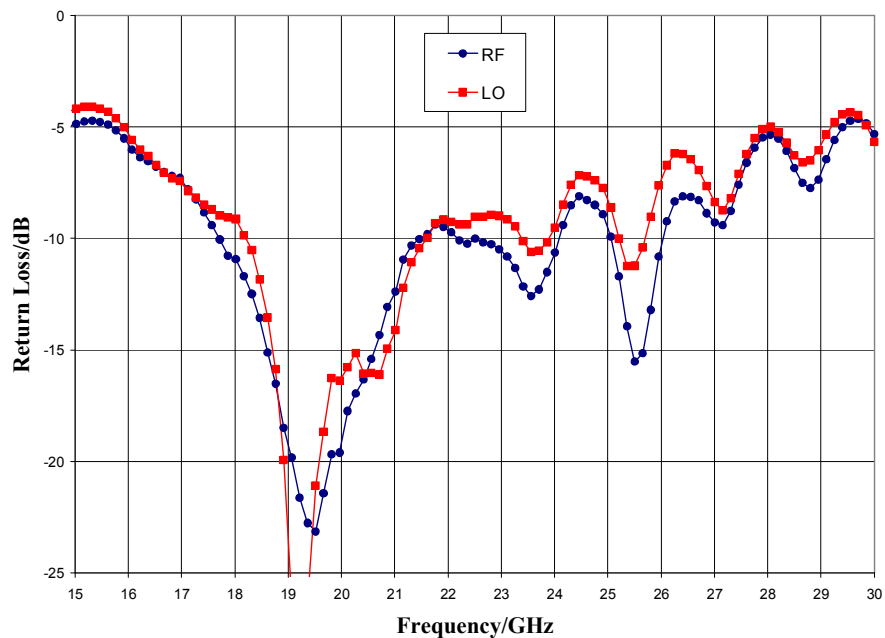

ver 1.6 1017

Typical Performance

IF Bandwidth, LO = +13 dBm

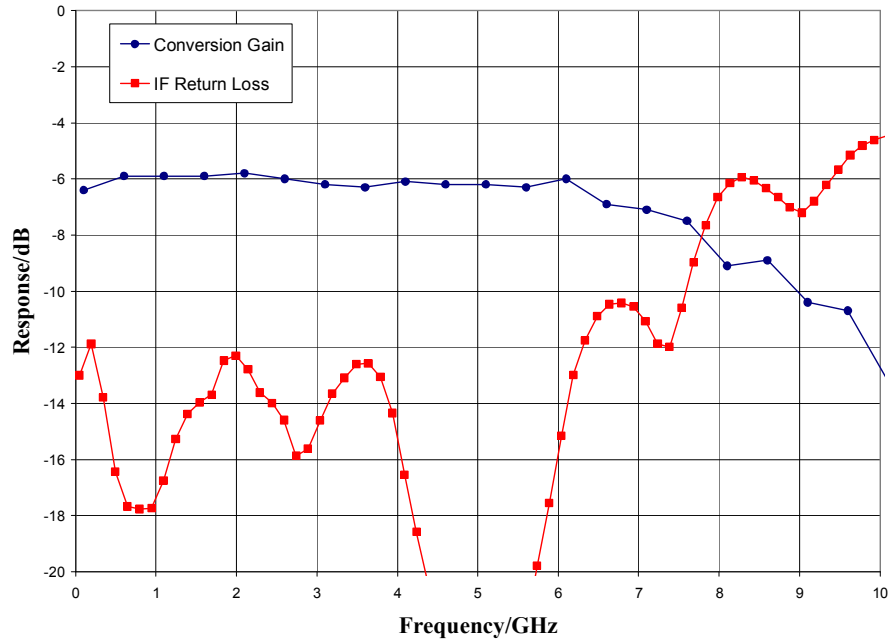

Upconverter Performance, Conversion Gain vs. LO Drive, IF input = 100 MHz

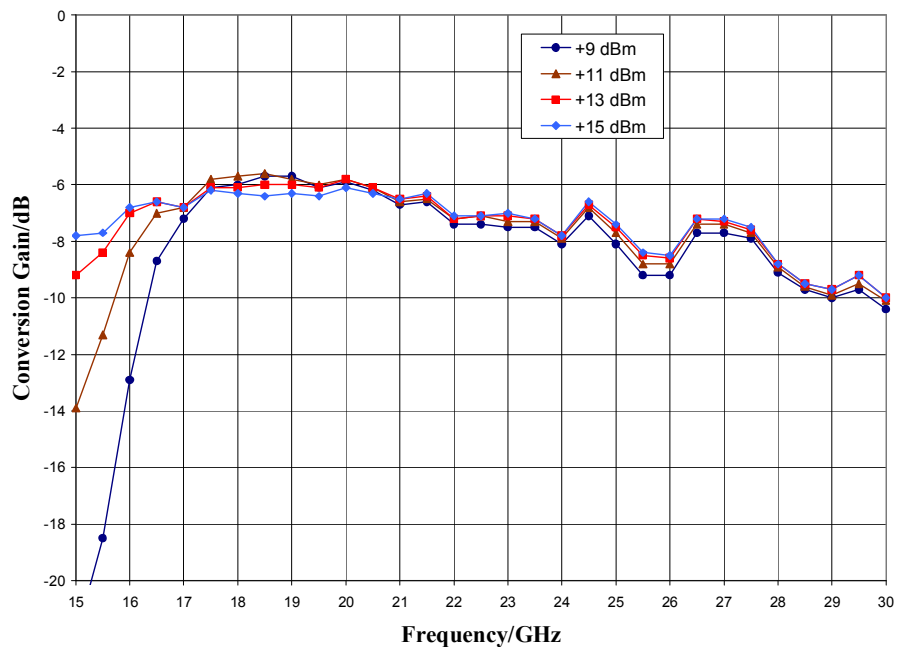

ver 1.6 1017

Typical Performance

Input IP3 vs. Temperature, LO = +15 dBm, IF = 100 MHz

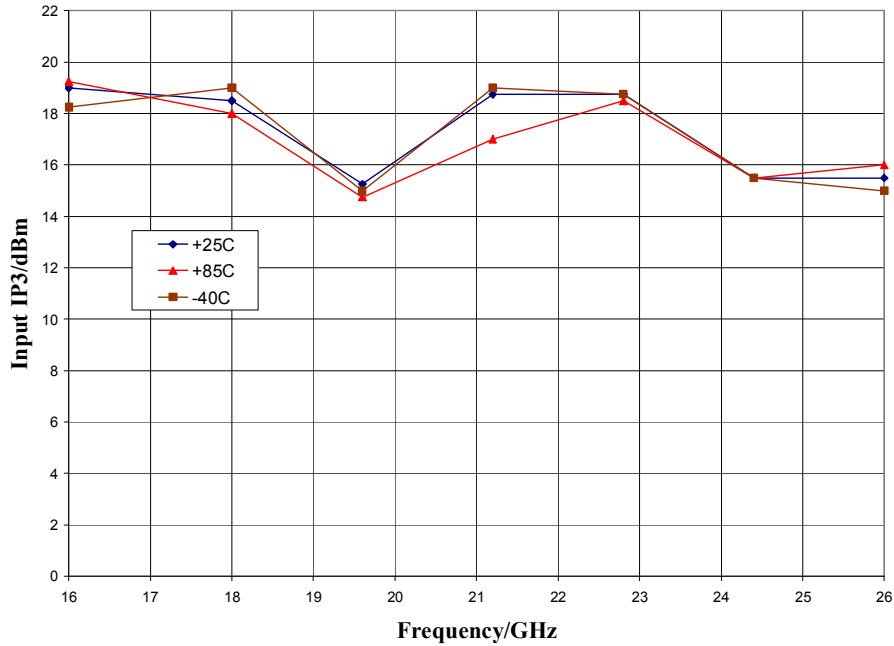

Input IP3 vs. LO Drive, IF = 100 MHz

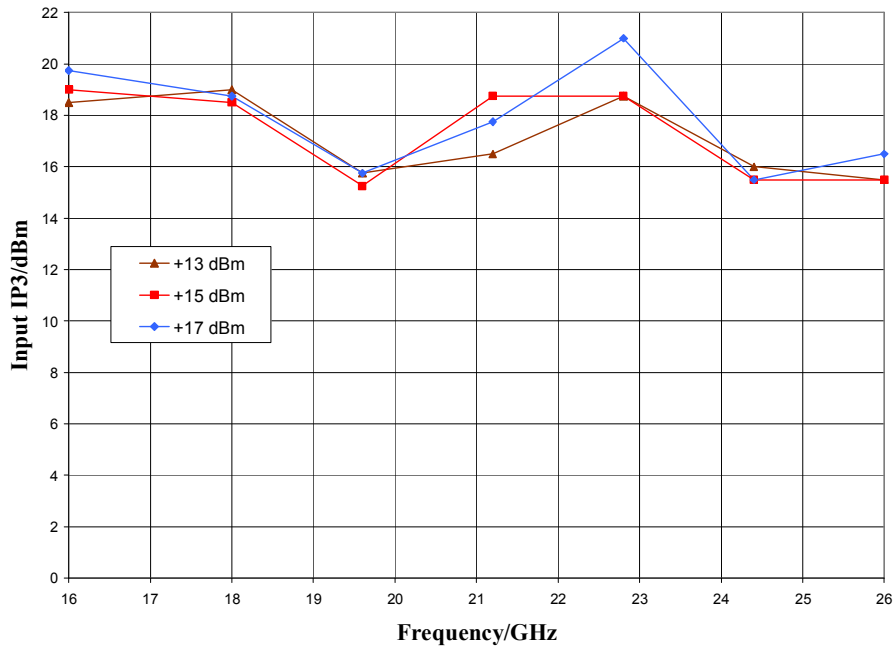

ver 1.6 1017

Typical Performance

Upconverter Performance, Input IP3 vs. LO Drive, IF = 100 MHz

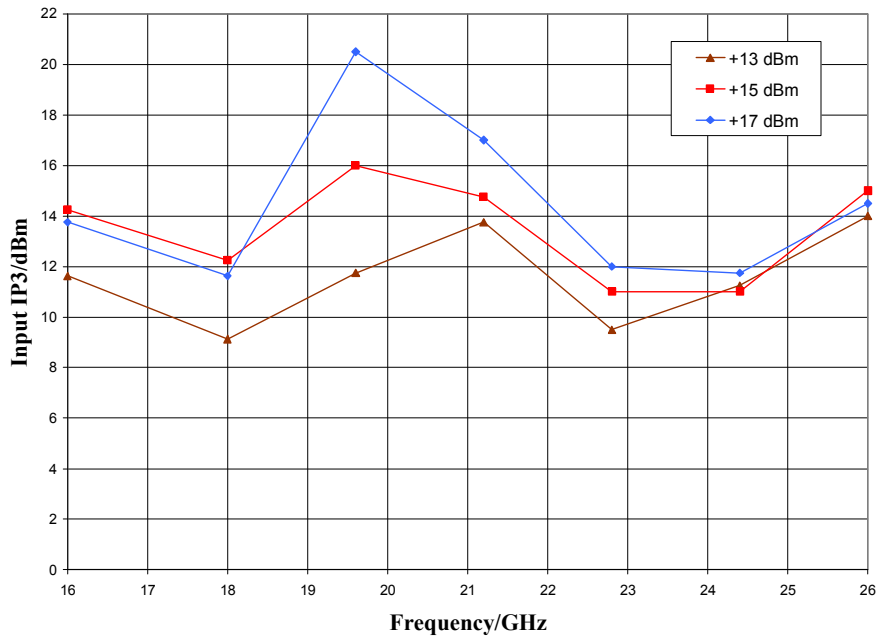

Input P1dB, LO = +13 dBm, IF = 100 MHz USB

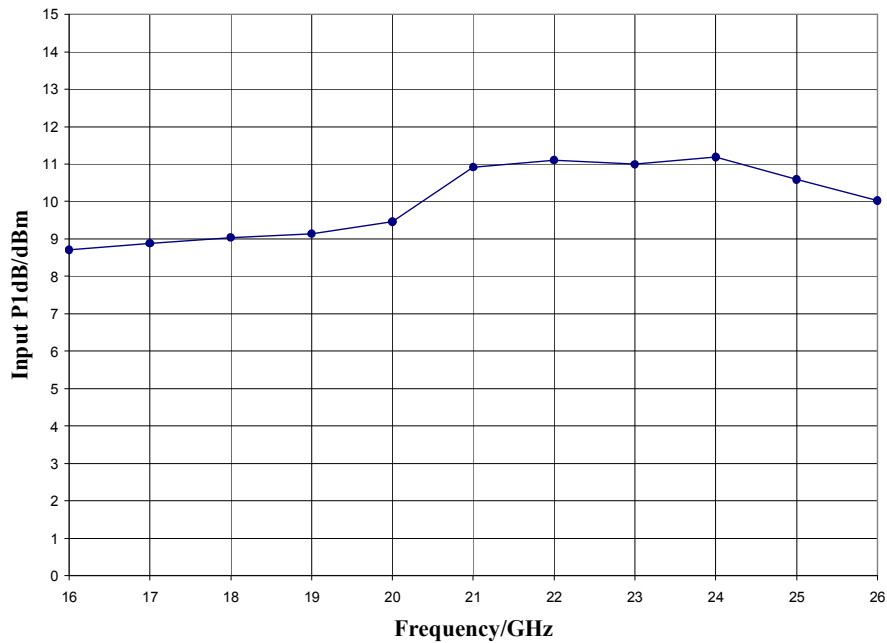

ver 1.6 1017

Mechanical Information

Package Information and Dimensions

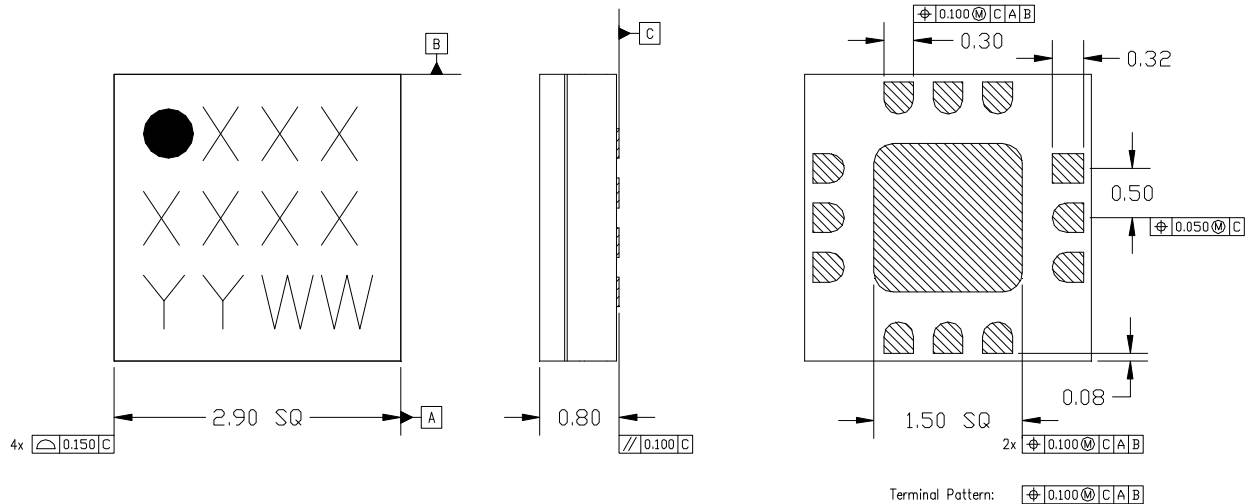

- NOTES:
1. ALL DIMENSIONS SHOWN IN mm.
 2. MATERIAL: BLACK ALUMINA
 3. LEAD FINISH:
 - 3.1. Ni: 8.89 μm MAX, 1.27 μm MIN
 - 3.2. Pd: 0.17 μm MAX, 0.07 μm MIN
 - 3.3. Au: 0.254 μm MAX, 0.03 μm MIN
 4. MARKING
 - 4.1. LINE 1: PART NUMBER
 - 4.1.1. EXAMPLE: CMD177C3 SHALL BE MARKED AS 177
 - 4.2. LINE 2: LDT NUMBER
 - 4.3. LINE 3: DATE CODE - LAST 2 DIGITS OF THE YEAR OF MANUFACTURE FOLLOWED BY A 2 DIGIT WEEK CODE
 5. ALTERNATE PIN #1 IDENTIFIER IS A SINGLE SQUARE PAD
 6. ALTERNATE DIE PADDLE MAY HAVE CHAMFERED CORNERS

Recommended PCB Land Pattern

Custom MMIC Design Services recommends that the user develop the land pattern that will provide the best design for proper solder reflow and device attach for their specific application. Please review Custom MMIC Application Note AN 105 for a recommended land pattern approach.

Recommended Solder Reflow Profile

Custom MMIC Design Services recommends screen printing with belt furnace reflow to ensure proper solder reflow and device attach. Please review Custom MMIC Application Note AN 102 for a recommended solder reflow profile.

Pin Description

Pin Diagram

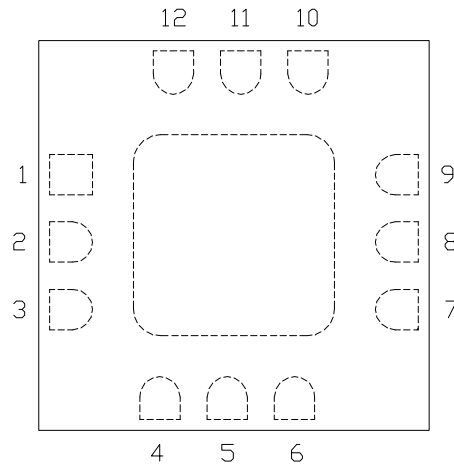

Functional Description

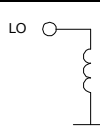
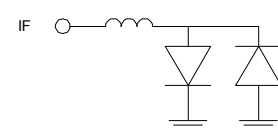
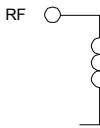
Pin	Function	Description	Schematic
1,3,4,6,7,9 and die paddle	Ground	Connect to RF / DC ground.	
2	LO	This pin is DC coupled and matched to 50 ohms.	
5	IF	This pin is DC coupled. For applications not requiring operation to DC, this port should be DC blocked externally using a series capacitor whose value has been chosen to pass the necessary IF frequency range. For operation to DC, this pin must not source or sink more than 16 mA of current or part non-function or part failure may result.	
8	RF	This pin is DC coupled and matched to 50 ohms.	
10-12	N/C	No connection required. These pins may be connected to RF/DC ground	

ver 1.6 1017

Applications Information

Evaluation Board

The circuit board shown has been developed for optimized assembly at Custom MMIC. A sufficient number of via holes should be used to connect the top and bottom ground planes. As surface mount processes vary, careful process development is recommended.

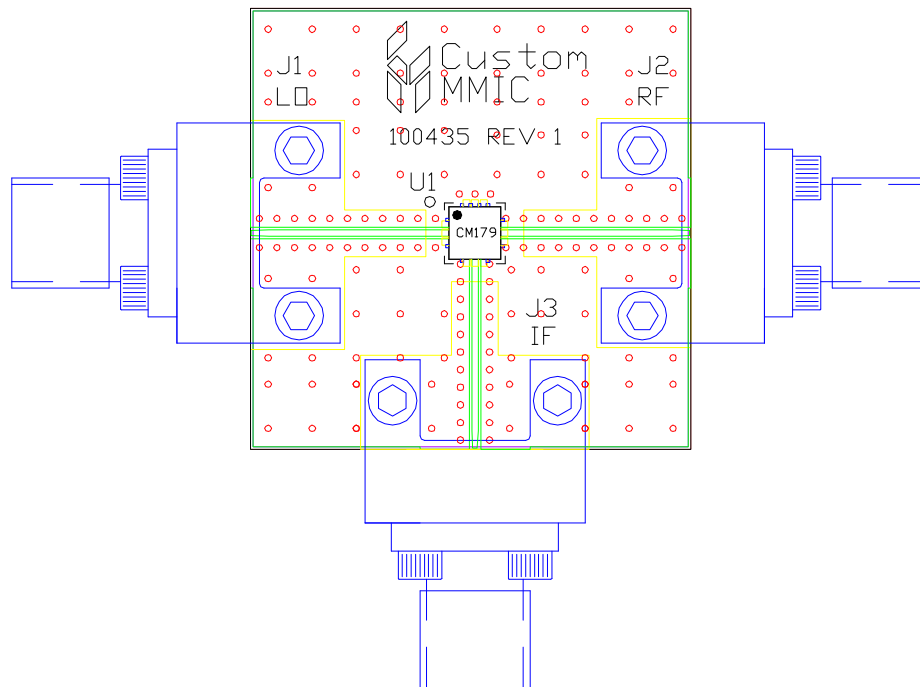

Bill of Material

Designator	Value	Description
J1 - J3		SMA End Launch Connector
U1		CMD179C3 Fundamental Mixer
PCB		100435 Evaluation PCB

GaAs MMIC devices are susceptible to damage from Electrostatic Discharge. Proper precautions should be observed during handling, assembly and test.

ver 1.6 1017

X-ON Electronics

Largest Supplier of Electrical and Electronic Components

Click to view similar products for [RF Mixer](#) category:

Click to view products by [Qorvo](#) manufacturer:

Other Similar products are found below :

[HMC337-SX](#) [HMC404-SX](#) [mamx-009646-23dbml](#) [HMC339-SX](#) [CHR3664-QEG](#) [HMC8192-SX](#) [MIQ24MS-2](#) [HMC220BMS8GETR](#) [M85C](#)
[HMC554A-SX](#) [HMC8192LG](#) [HMC521A-SX](#) [HMC521ACHIPS](#) [CMD258C4](#) [CMD258](#) [LT5511EFE](#) [MAMX-011023-SMB](#)
[HMC399MS8TR](#) [HMC333TR](#) [HMC214MS8TR](#) [HMC175MS8TR](#) [HMC1043LC3TR](#) [MAMXSS0012TR-3000](#) [109728-HMC129LC4](#) [CSM1-](#)
[13](#) [SA612AD/01.112](#) [HMC785LP4ETR](#) [LT5579IUH#PBF](#) [HMC773ALC3BTR](#) [HMC558ALC3B](#) [HMC329ALC3B](#) [MY63H](#)
[AD8343ARUZ-REEL7](#) [AD608AR](#) [AD608ARZ](#) [AD831APZ](#) [AD831APZ-REEL7](#) [AD8342ACPZ-REEL7](#) [AD8343ARUZ](#) [AD8344ACPZ-](#)
[REEL7](#) [ADL5350ACPZ-R7](#) [ADL5363ACPZ-R7](#) [ADL5365ACPZ-R7](#) [ADL5801ACPZ-R7](#) [ADL5802ACPZ-R7](#) [HMC1056LP4BE](#)
[HMC1057-SX](#) [HMC1063LP3E](#) [HMC1093-SX](#) [HMC1106-SX](#)