

### Product Overview

The CMD307P3 is a broadband MMIC low noise amplifier housed in a leadless 3x3 mm plastic surface mount package. The CMD307P3 is ideally suited for EW and communication systems where small size and low power consumption are needed. The device operates from 8 to 16 GHz and delivers greater than 17 dB of gain with a corresponding output 1 dB compression point of +12 dBm and noise figure of 2 dB. The CMD307P3 is a 50 ohm matched design which eliminates the need for external DC blocks and RF port matching.

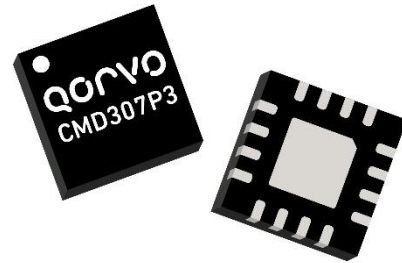

### Functional Block Diagram

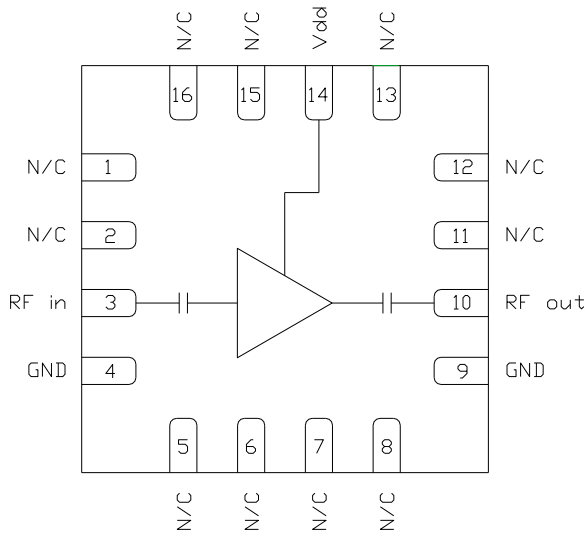

### Key Features

- Low Noise Figure
- Low Current Consumption
- Single Positive Supply Voltage
- Pb-Free RoHs Compliant 3x3 QFN Package

### Ordering Information

Part No.	Description
CMD307P3	100 pcs on 7" reel
CMD307P3-EVB	Evaluation Board

### Electrical Performance ( $V_{dd} = 3.0\text{ V}$ , $T_A = 25^\circ\text{C}$ , $F = 12\text{ GHz}$ )

Parameter	Min	Typ	Max	Units
Frequency Range		8 - 16		GHz
Gain		17		dB
Noise Figure		2		dB
Input Return Loss		11		dB
Output Return Loss		16		dB
Output P1dB		12		dBm
Supply Current		55		mA

## Absolute Maximum Ratings

Parameter	Rating
Drain Voltage, $V_{dd}$	5 V
RF Input Power	+20 dBm
Channel Temperature, $T_{ch}$	150° C
Power Dissipation, $P_{diss}$	338 mW
Thermal Resistance, $Q_{JC}$	192° C/W
Operating Temperature	-40 to 85° C
Storage Temperature	-55 to 150° C

Exceeding any one or combination of the maximum ratings may cause permanent damage to the device.

## Recommended Operating Conditions

Parameter	Min	Typ	Max	Units
$V_{dd}$	2.0	3.0	4.0	V
$I_{dd}$		55		mA

Electrical performance is measured at specific test conditions. Electrical specifications are not guaranteed over all recommended operating conditions.

## Electrical Specifications ( $V_{dd} = 3.0$ V, $T_A = 25^\circ$ C)

Parameter	Min	Typ	Max	Min	Typ	Max	Units
Frequency Range		8 - 11			11 - 16		GHz
Gain	14	17.5		13	17		dB
Noise Figure		2.2	2.9		2	2.6	dB
Input Return Loss		10			13		dB
Output Return Loss		12			15		dB
Output P1dB		11			11.5		dBm
Output IP3		25			25		dBm
Supply Current	40	55	70	40	55	70	mA
Gain Temperature Coefficient		0.011			0.011		dB/°C
Noise Figure Temperature Coefficient		0.009			0.009		dB/°C

Typical Performance

Broadband Performance,  $V_{dd} = 3.0\text{ V}$ ,  $T_A = 25^\circ\text{ C}$

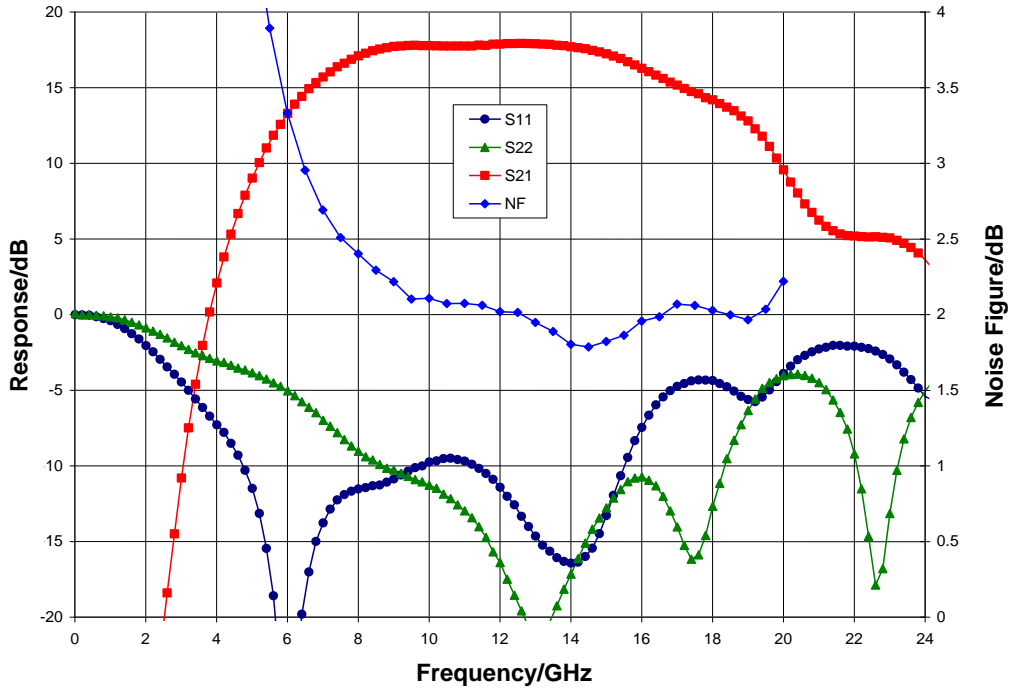

Narrow-band Performance,  $V_{dd} = 3.0\text{ V}$ ,  $T_A = 25^\circ\text{ C}$

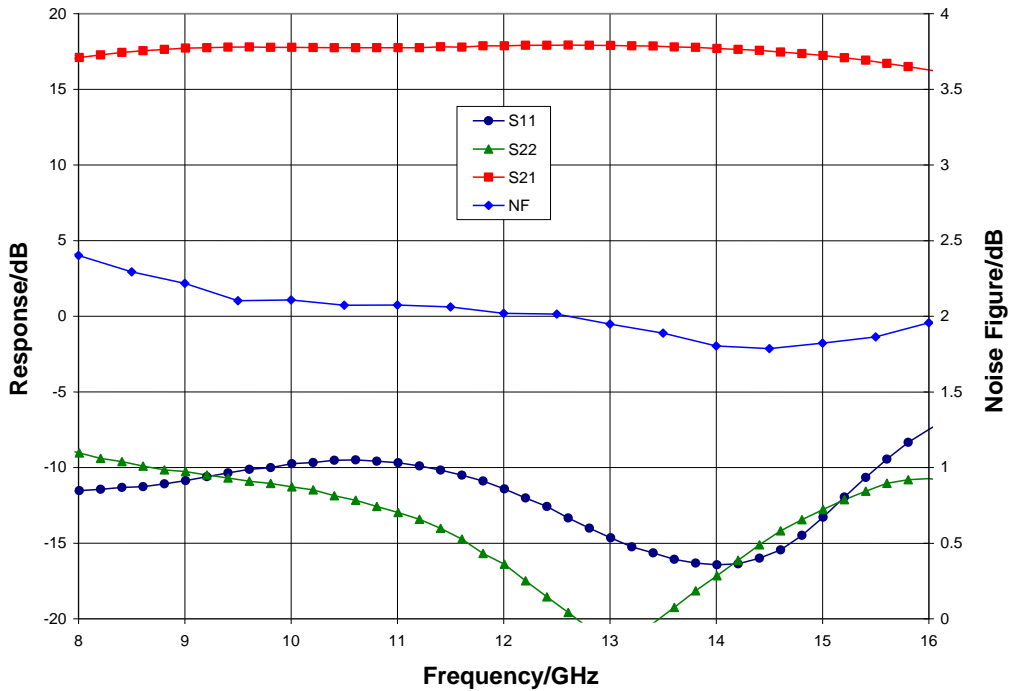

Typical Performance

Gain vs. Temperature,  $V_{dd} = 3.0\text{ V}$

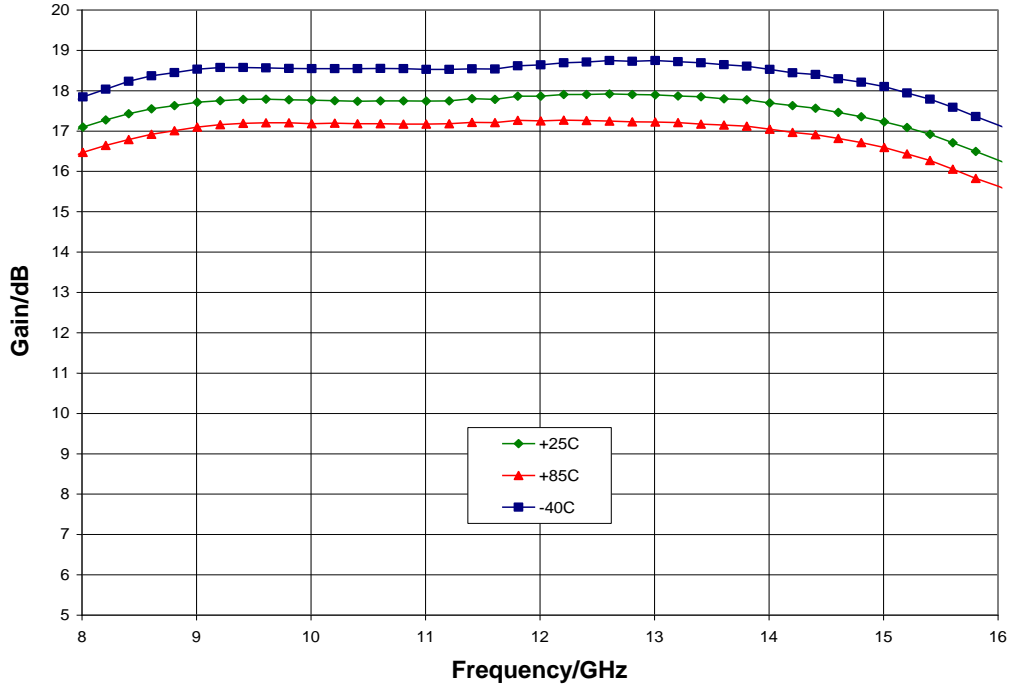

Gain vs.  $V_{dd}$ ,  $T_A = 25^\circ\text{ C}$

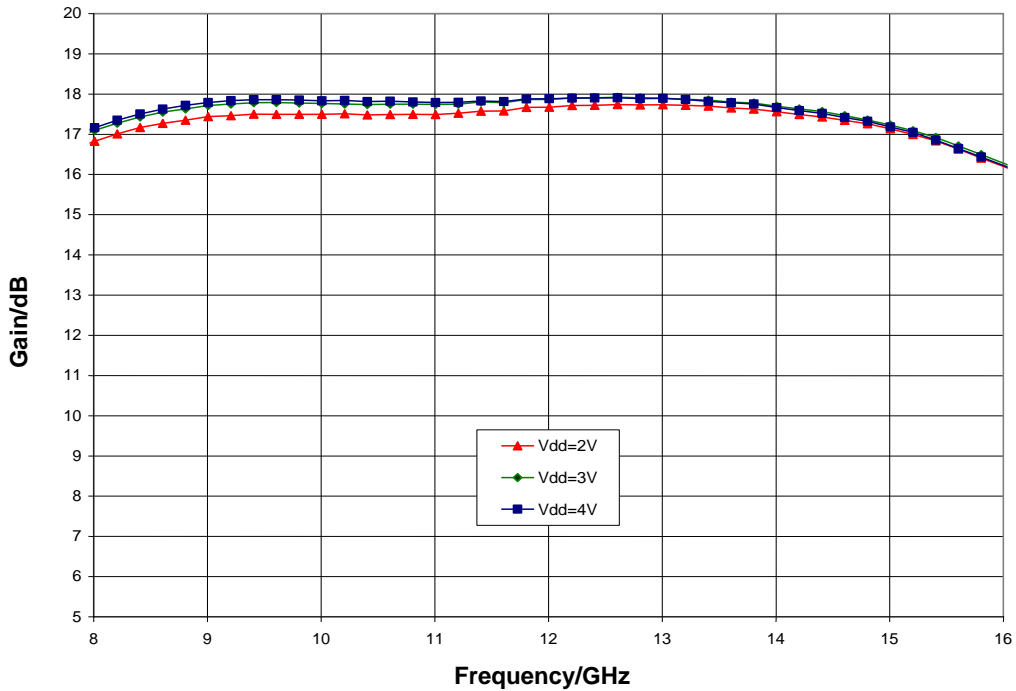

Typical Performance

Noise Figure vs. Temperature,  $V_{dd} = 3.0\text{ V}$

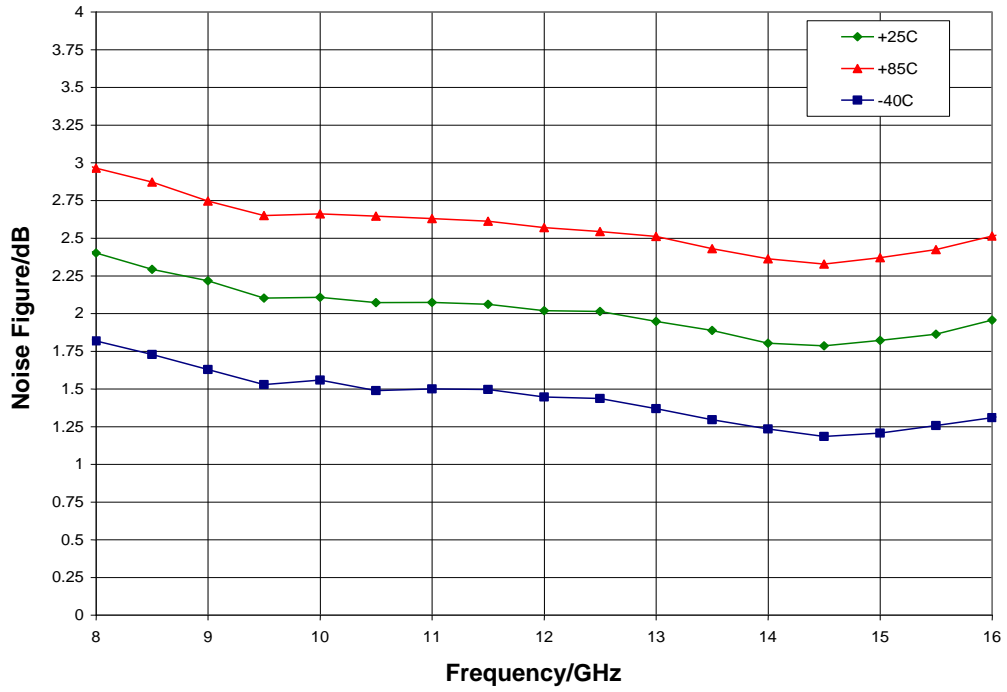

Noise Figure vs.  $V_{dd}$ ,  $T_A = 25^\circ\text{ C}$

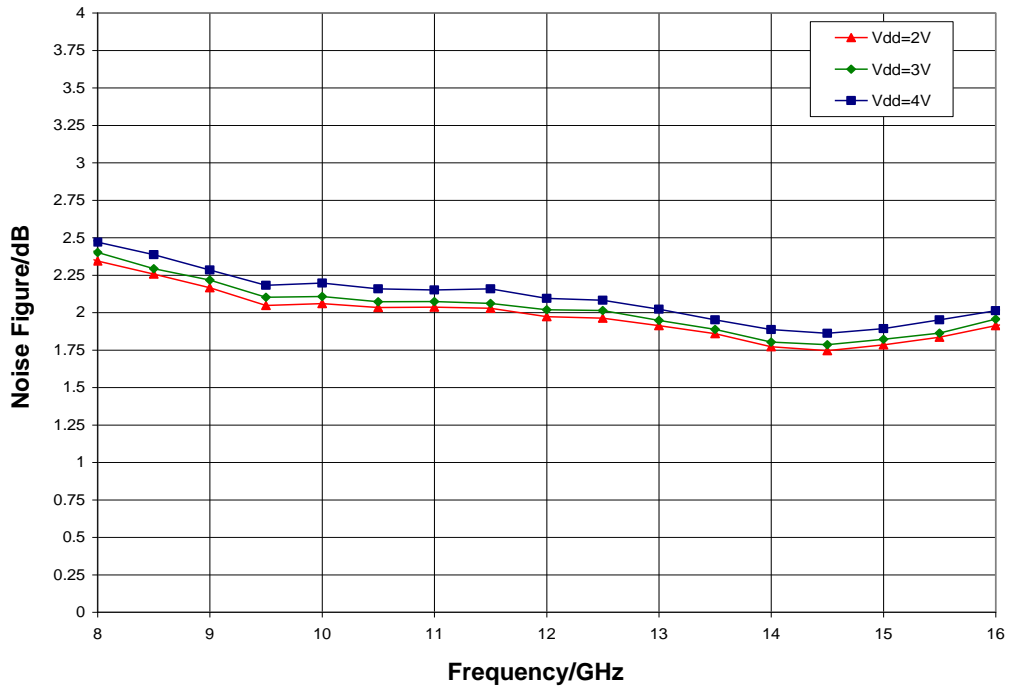

Typical Performance

P1dB vs. Temperature,  $V_{dd} = 3.0\text{ V}$

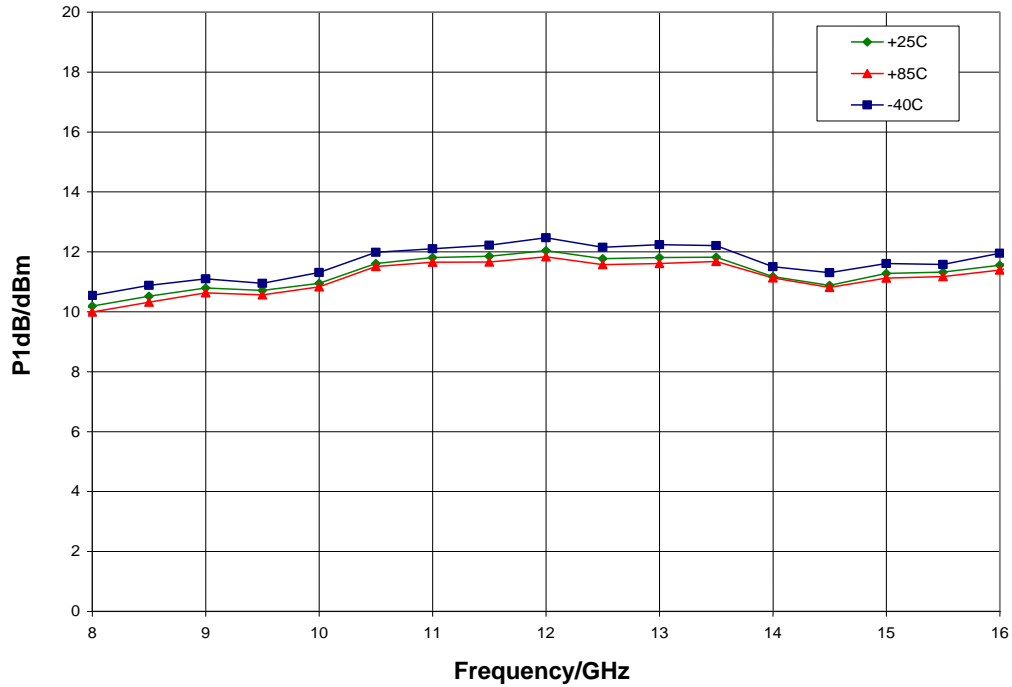

P1dB vs.  $V_{dd}$ ,  $T_A = 25^\circ\text{C}$

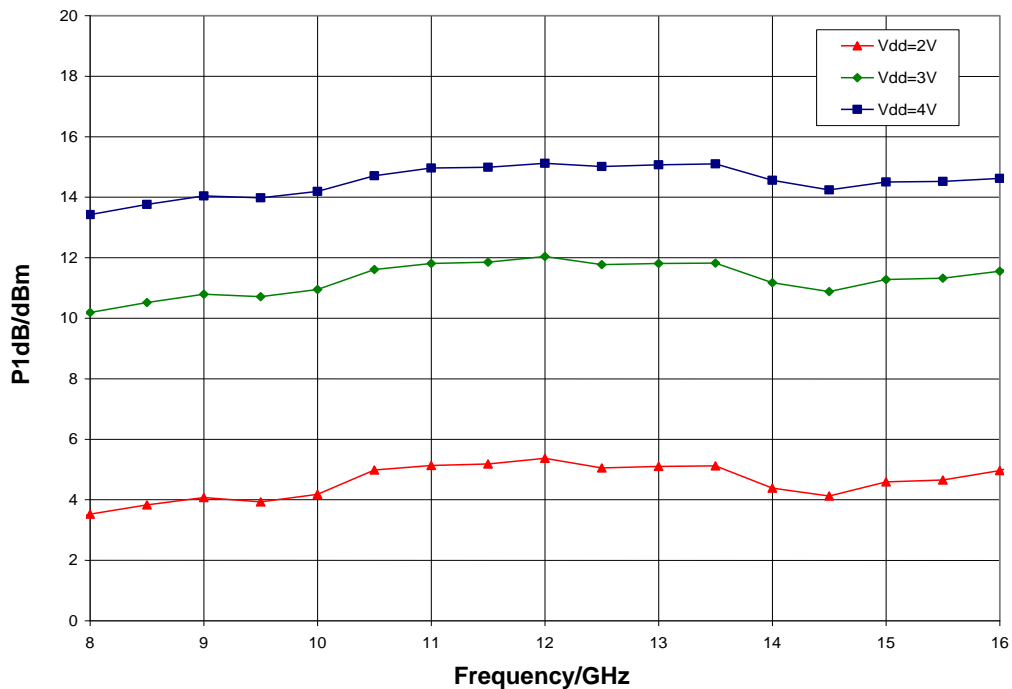

Typical Performance

Psat vs. Temperature,  $V_{dd} = 3.0\text{ V}$

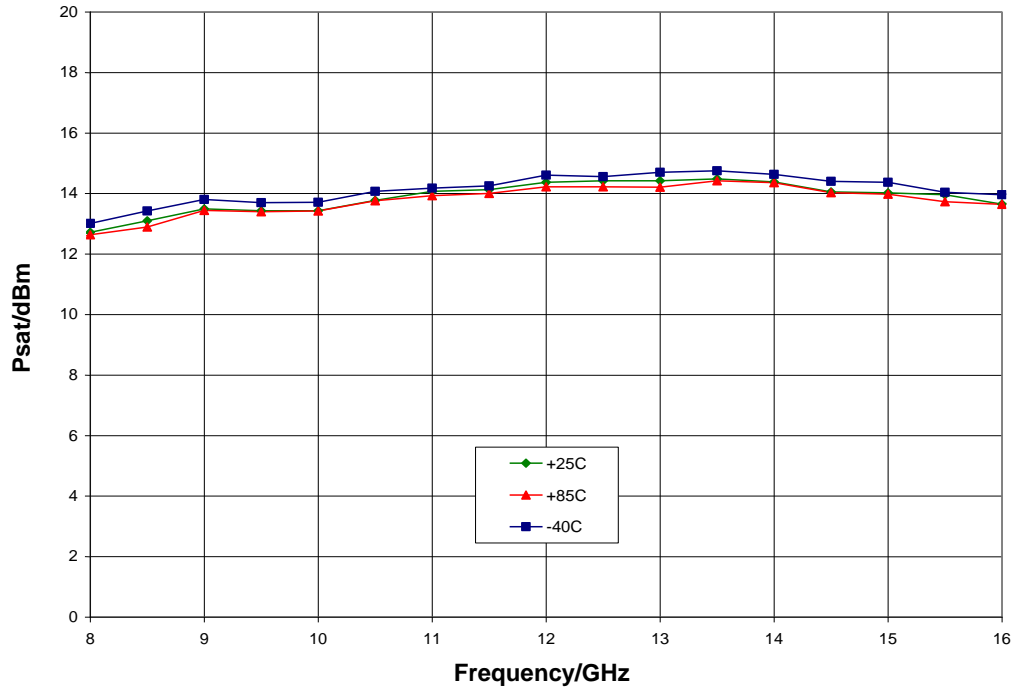

Psat vs.  $V_{dd}$ ,  $T_A = 25^\circ\text{C}$

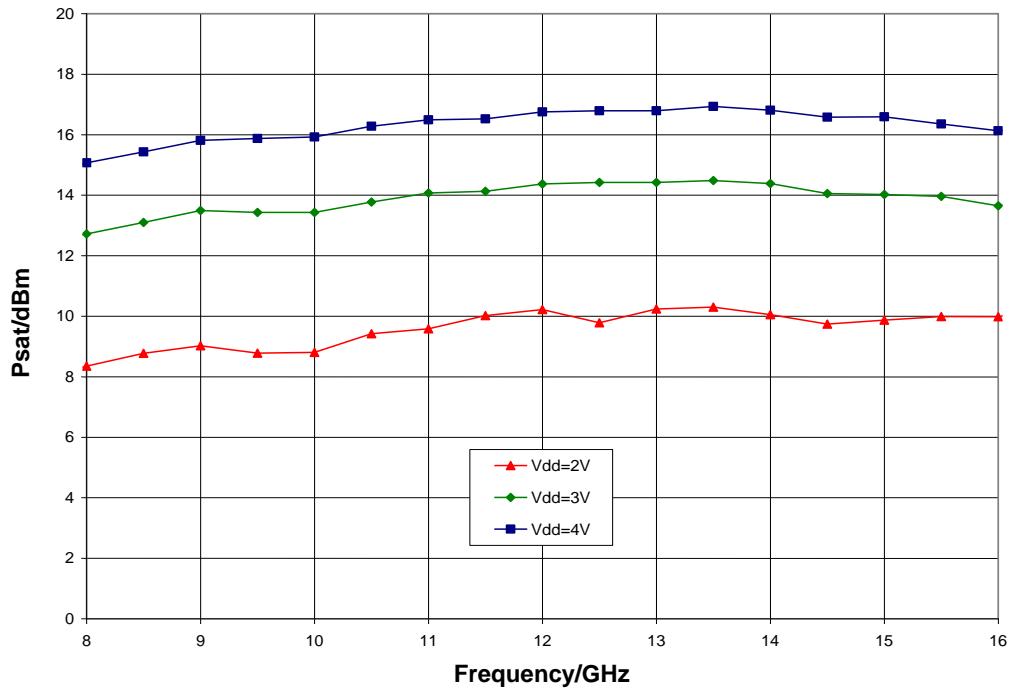

Typical Performance

Output IP3 vs. Temperature,  $V_{dd} = 3.0\text{ V}$

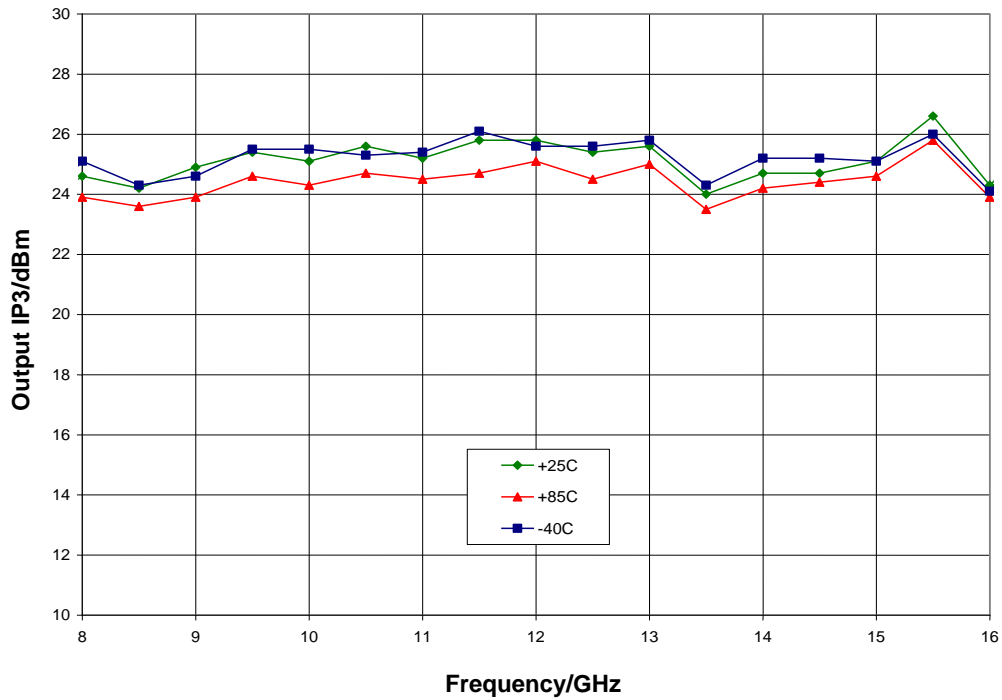

Output IP3 vs.  $V_{dd}$ ,  $T_A = 25^\circ\text{C}$

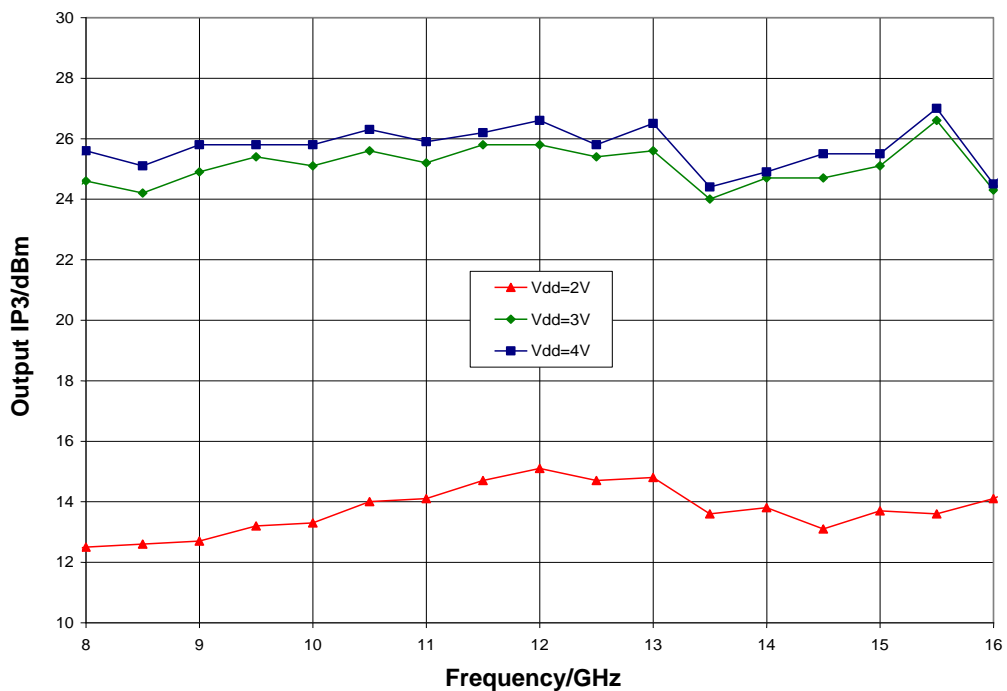



**Mechanical Information**

**Package Information and Dimensions**

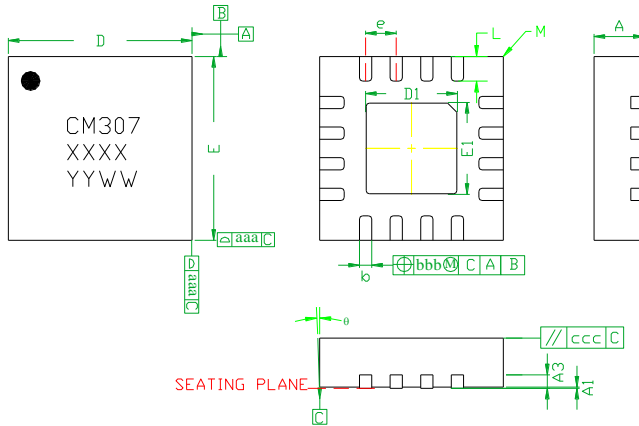

SYMBOLS	DIMENSIONS IN MILLIMETERS		
	MIN	NOM	MAX
A	0.80	0.90	1.00
A1	0	0.02	0.05
A3	---	0.25REF.	---
b	0.17	0.23	0.30
D	2.85	3.00	3.15
D1	1.5	1.6	1.7
E	2.85	3.00	3.15
E1	1.5	1.6	1.7
e	---	0.50BSC	---
L	0.30	0.40	0.50
o	0	---	12
aaa	---	0.25	---
bbb	---	0.10	---
ccc	---	0.10	---
M	---	---	0.05

**Notes:**

1. Dimensions are in millimeters
2. RoHs compliant mold compound
3. Lead frame material: Copper alloy
4. Lead finish: 100% matte Sn
5. Indicated dimension/tolerance applies to leads and exposed pad

**Recommended PCB Land Pattern**

Qorvo recommends that the user develop the land pattern that will provide the best design for proper solder reflow and device attach for their specific application. Please review Qorvo Application Note AN 105 for a recommended land pattern approach.

**Recommended Solder Reflow Profile**

Qorvo recommends screen printing with belt furnace reflow to ensure proper solder reflow and device attach. Please review Qorvo Application Note AN 102 for a recommended solder reflow profile.

## Pin Description

### Pin Diagram

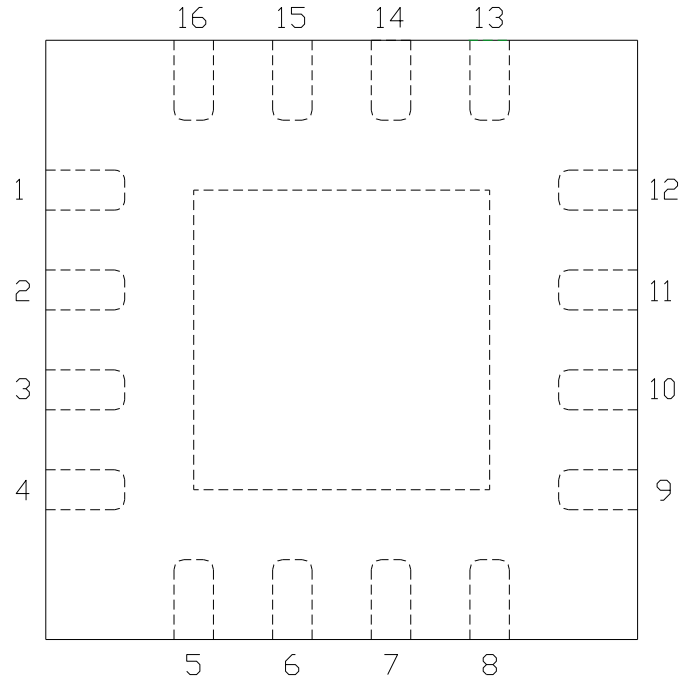

### Functional Description

Pin	Function	Description	Schematic
1, 2, 5 - 8, 11 - 13, 15, 16	N/C	No connection required These pins may be connected to RF / DC ground	
3	RF in	DC blocked and 50 ohm matched	
10	RF out	DC blocked and 50 ohm matched	
14	V <sub>dd</sub>	Power supply voltage Decoupling and bypass caps required	
4, 9 and die paddle	Ground	Connect to RF / DC ground	

**Applications Information**

**Application Circuit**

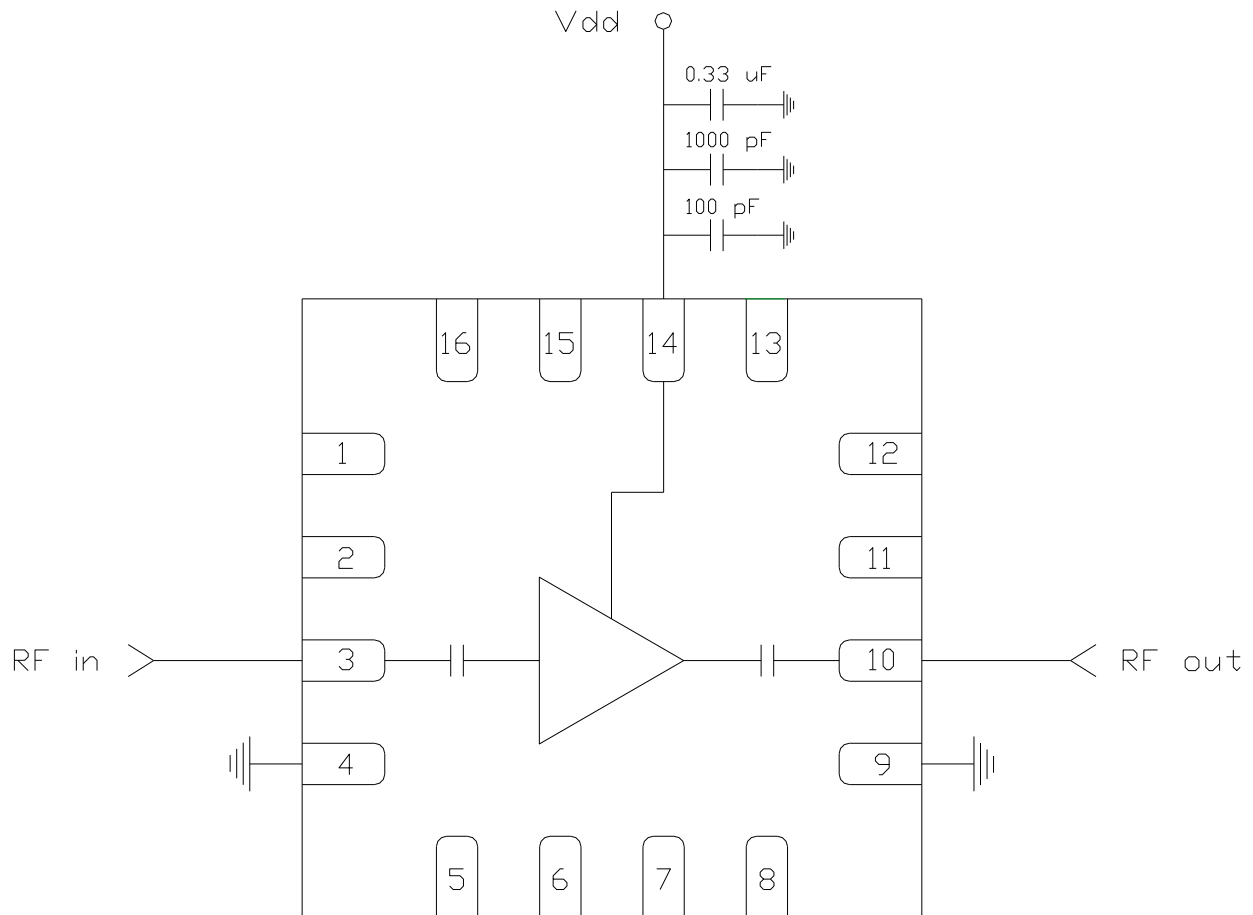

**Biasing and Operation**

The CMD307P3 is biased with a single 3.0 V positive drain supply.

RF power can be applied at any time.

**GaAs MMIC devices are susceptible to damage from Electrostatic Discharge. Proper precautions should be observed during handling, assembly and test.**

## Applications Information

### Evaluation Board

The circuit board shown has been developed for optimized assembly at Qorvo. A sufficient number of via holes should be used to connect the top and bottom ground planes. As surface mount processes vary, careful process development is recommended.

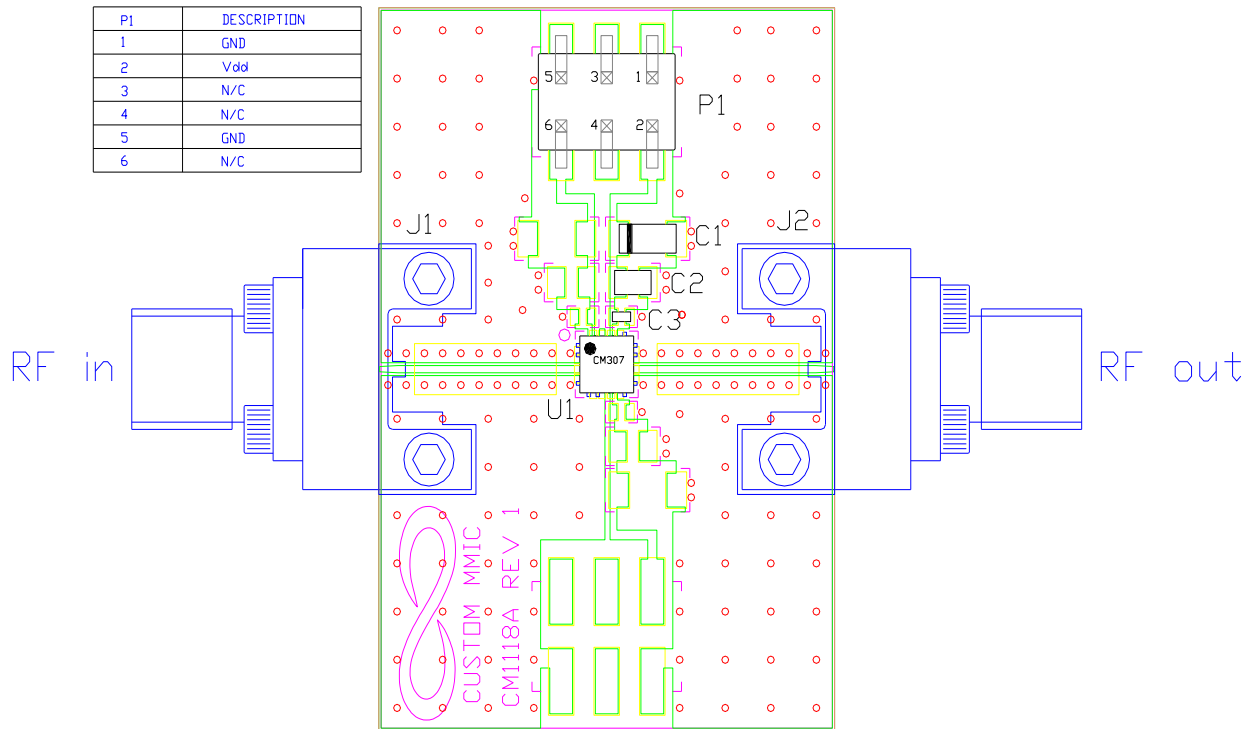

## Bill of Material

Designator	Value	Description
J1, J2		SMA End Launch Connector
P1		6 Pin Header
C1	0.33 $\mu$ F	Capacitor, Tantalum
C2	1000 pF	Capacitor, 0603
C3	100 pF	Capacitor, 0402
U1		CMD307P3 Low Noise Amplifier
PCB		CM118A Evaluation PCB

## Handling Precautions

Parameter	Rating	Standard
ESD – Human Body Model (HBM)	Class 1A	ESDA / JEDEC JS-001-2012
MSL – Moisture Sensitivity Level	Level 1	IPC/JEDEC J-STD-020



Caution!  
ESD-Sensitive Device

## RoHS Compliance

This part is compliant with 2011/65/EU RoHS directive (Restrictions on the Use of Certain Hazardous Substances in Electrical and Electronic Equipment) as amended by Directive 2015/863/EU.

This product also has the following attributes:

- Lead Free
- Antimony Free
- TBBP-A (C<sub>15</sub>H<sub>12</sub>Br<sub>4</sub>O<sub>2</sub>) Free
- SVHC Free
- PFOS Free
- Halogen Free



## Contact Information

For the latest specifications, additional product information, worldwide sales and distribution locations:

**Web:** [www.qorvo.com](http://www.qorvo.com)

**Tel:** 1-844-890-8163

**Email:** [customer.support@qorvo.com](mailto:customer.support@qorvo.com)

## Important Notice

The information contained in this Data Sheet and any associated documents (“Data Sheet Information”) is believed to be reliable; however, Qorvo makes no warranties regarding the Data Sheet Information and assumes no responsibility or liability whatsoever for the use of said information. All Data Sheet Information is subject to change without notice. Customers should obtain and verify the latest relevant Data Sheet Information before placing orders for Qorvo® products. Data Sheet Information or the use thereof does not grant, explicitly, implicitly or otherwise any rights or licenses to any third party with respect to patents or any other intellectual property whether with regard to such Data Sheet Information itself or anything described by such information.

DATA SHEET INFORMATION DOES NOT CONSTITUTE A WARRANTY WITH RESPECT TO THE PRODUCTS DESCRIBED HEREIN, AND QORVO HEREBY DISCLAIMS ANY AND ALL WARRANTIES WITH RESPECT TO SUCH PRODUCTS WHETHER EXPRESS OR IMPLIED BY LAW, COURSE OF DEALING, COURSE OF PERFORMANCE, USAGE OF TRADE OR OTHERWISE, INCLUDING THE IMPLIED WARRANTIES OF MERCHANTABILITY AND FITNESS FOR A PARTICULAR PURPOSE. Without limiting the generality of the foregoing, Qorvo® products are not warranted or authorized for use as critical components in medical, life-saving, or life-sustaining applications, or other applications where a failure would reasonably be expected to cause severe personal injury or death. Applications described in the Data Sheet Information are for illustrative purposes only. Customers are responsible for validating that a particular product described in the Data Sheet Information is suitable for use in a particular application.

© 2020 Qorvo US, Inc. All rights reserved. This document is subject to copyright laws in various jurisdictions worldwide and may not be reproduced or distributed, in whole or in part, without the express written consent of Qorvo US, Inc. | QORVO® is a registered trademark of Qorvo US, Inc.

## X-ON Electronics

Largest Supplier of Electrical and Electronic Components

*Click to view similar products for [RF Development Tools](#) category:*

*Click to view products by [Qorvo](#) manufacturer:*

Other Similar products are found below :

[MAAM-011117](#) [MAAP-015036-DIEEV2](#) [EV1HMC1113LP5](#) [EV1HMC6146BLC5A](#) [EV1HMC637ALP5](#) [EVAL-ADG919EBZ](#) [ADL5363-EVALZ](#) [LMV228SDEVAL](#) [SKYA21001-EVB](#) [SMP1331-085-EVB](#) [EV1HMC618ALP3](#) [EVAL01-HMC1041LC4](#) [MAAL-011111-000SMB](#)  
[MAAM-009633-001SMB](#) [MASW-000936-001SMB](#) [107712-HMC369LP3](#) [107780-HMC322ALP4](#) [SP000416870](#) [EV1HMC470ALP3](#)  
[EV1HMC520ALC4](#) [EV1HMC244AG16](#) [MAX2614EVKIT#](#) [124694-HMC742ALP5](#) [SC20ASATEA-8GB-STD](#) [MAX2837EVKIT+](#)  
[MAX2612EVKIT#](#) [MAX2692EVKIT#](#) [EV1HMC629ALP4E](#) [SKY12343-364LF-EVB](#) [108703-HMC452QS16G](#) [EV1HMC863ALC4](#)  
[EV1HMC427ALP3E](#) [119197-HMC658LP2](#) [EV1HMC647ALP6](#) [ADL5725-EVALZ](#) [MAX2371EVKIT#](#) [106815-HMC441LM1](#)  
[EV1HMC1018ALP4](#) [UXN14M9PE](#) [MAX2016EVKIT](#) [EV1HMC939ALP4](#) [MAX2410EVKIT](#) [MAX2204EVKIT+](#) [EV1HMC8073LP3D](#)  
[SIMSA868-DKL](#) [SIMSA868C-DKL](#) [SKY65806-636EK1](#) [SKY68020-11EK1](#) [SKY67159-396EK1](#) [SKY66181-11-EK1](#)