

Product Overview

The CMD317C4 is a wideband GaAs MMIC driver amplifier housed in a leadless 4x4 mm surface mount package. The CMD317C4 is ideally suited for military, space and communications systems where small size and high linearity are needed. At 12 GHz the device delivers 16 dB of gain with a corresponding output 1 dB compression point of +23 dBm and an output IP3 of 35 dBm. The CMD317C4 is a 50 ohm matched design which eliminates the need for RF port matching and includes an on chip bias choke.

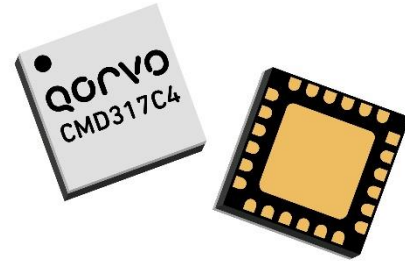

Functional Block Diagram

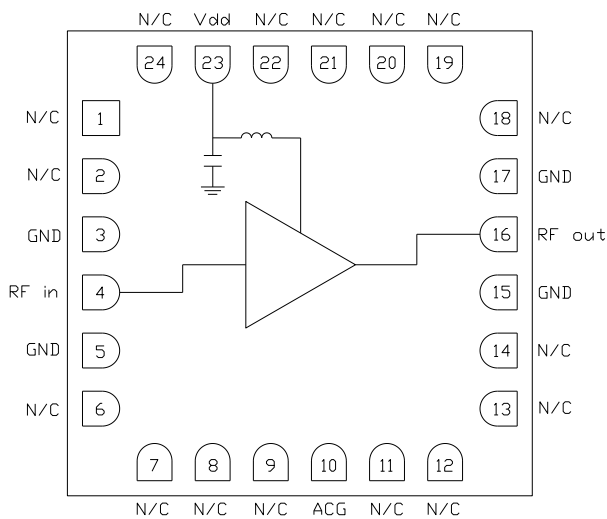

Key Features

- Wide Bandwidth
- High Linearity
- Single Positive Supply Voltage
- On Chip Bias Choke
- Pb-Free RoHs Compliant 4x4 mm SMT Package

Ordering Information

Part No.	Description
CMD317C4	100 pcs on 7" reel
CMD317C4-EVB	Evaluation Board

Electrical Performance ($V_{dd} = 8.0\text{ V}$, $T_A = 25^\circ\text{C}$, $F = 12\text{ GHz}$)

Parameter	Min	Typ	Max	Units
Frequency Range		1 - 24		GHz
Gain		16		dB
Input Return Loss		18		dB
Output Return Loss		16		dB
Output P1dB		23		dBm
Output IP3		35		dBm
Supply Current		225		mA

Absolute Maximum Ratings

Parameter	Rating
Drain Voltage, V_{dd}	9 V
RF Input Power	+20 dBm
Channel Temperature, T_{ch}	150° C
Power Dissipation, P_{diss}	2.62 W
Thermal Resistance, Q_{JC}	24.8° C/W
Operating Temperature	-55 to 85° C
Storage Temperature	-55 to 150° C

Exceeding any one or combination of the maximum ratings may cause permanent damage to the device.

Recommended Operating Conditions

Parameter	Min	Typ	Max	Units
V_{dd}	5.0	8.0	8.5	V
I_{dd}		225		mA

Electrical performance is measured at specific test conditions. Electrical specifications are not guaranteed over all recommended operating conditions.

Drain Current vs. Drain Voltage

V_{dd} (V)	I_{dd} (mA)
5.0	130
8.0	225

Electrical Specifications ($V_{dd} = 8.0$ V, $T_A = 25^\circ$ C)

Parameter	Min	Typ	Max	Min	Typ	Max	Min	Typ	Max	Units
Frequency Range	1 - 10			10 - 20			20 - 24			GHz
Gain	10.5	15		12.5	17		9.5	15		dB
Noise Figure		4			3.5			6.5		dB
Input Return Loss		15			15			10		dB
Output Return Loss		13			10			12		dB
Output P1dB	19.5	23		18	22		15	19		dBm
Output IP3		36			34			27		dBm
Supply Current	170	225	280	170	225	280	170	225	280	mA
Gain Temperature Coefficient		0.012			0.014			0.023		dB/°C
Noise Figure Temperature Coefficient		0.009			0.012			0.016		dB/°C

Typical Performance

Broadband Performance, $V_{dd} = 8.0\text{ V}$, $T_A = 25^\circ\text{ C}$

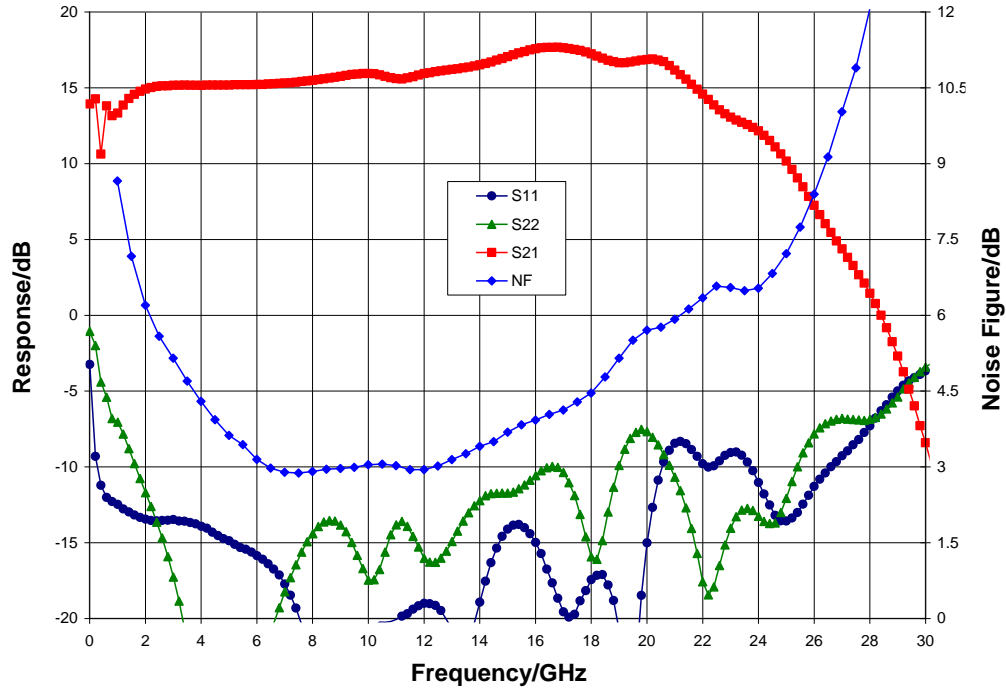

Narrow-band Performance, $V_{dd} = 8.0\text{ V}$, $T_A = 25^\circ\text{ C}$

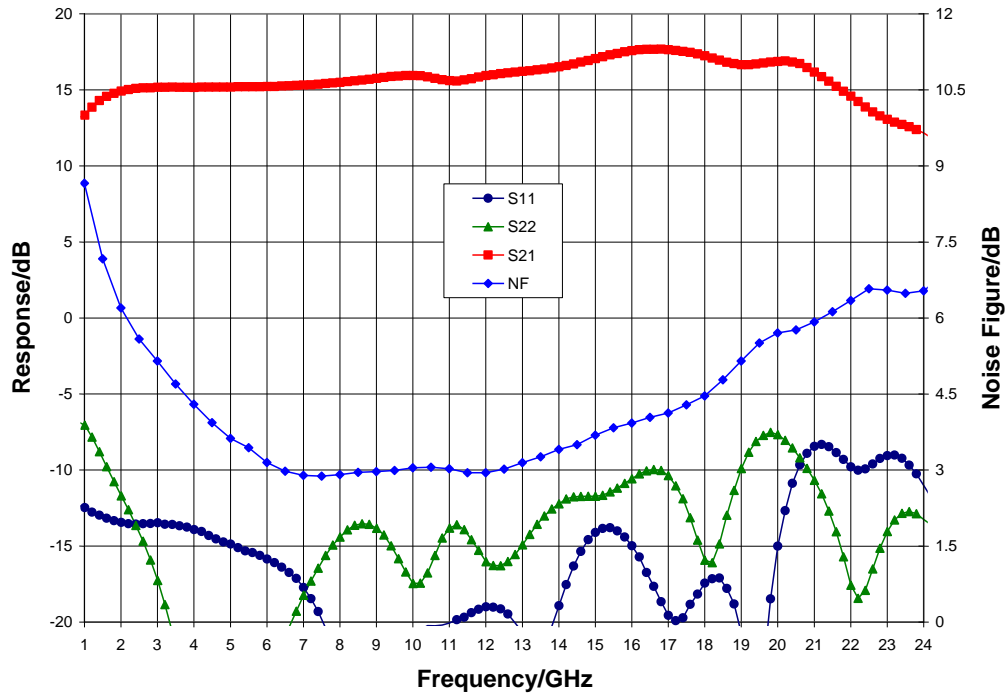

Typical Performance

Gain vs. Temperature, $V_{dd} = 8.0\text{ V}$

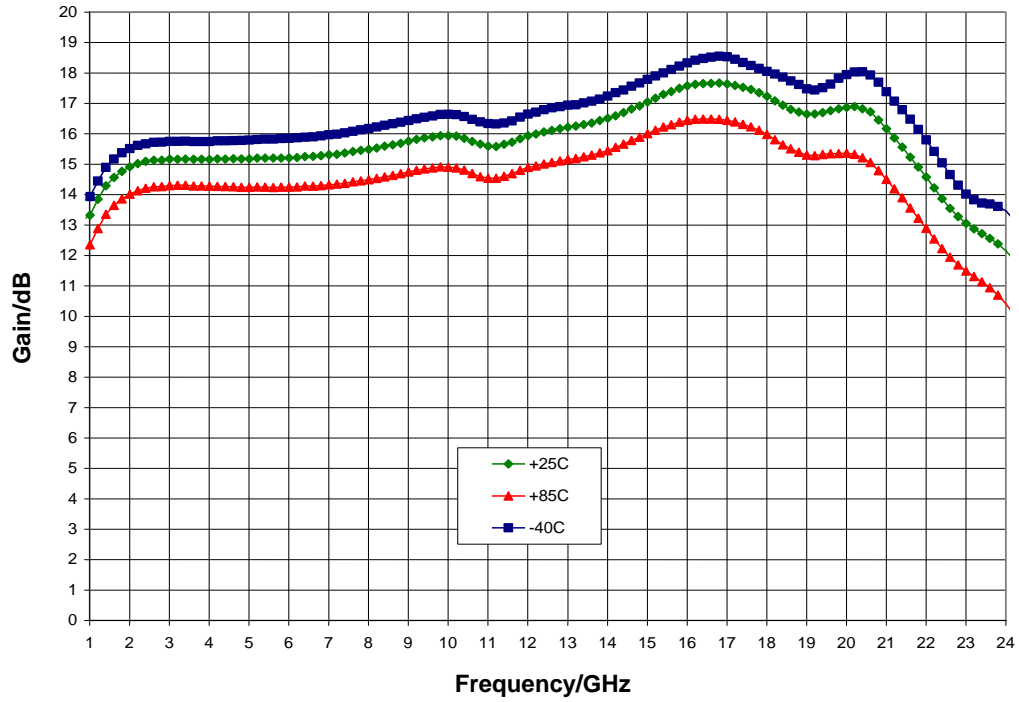

Gain vs. V_{dd} , $T_A = 25^\circ\text{ C}$

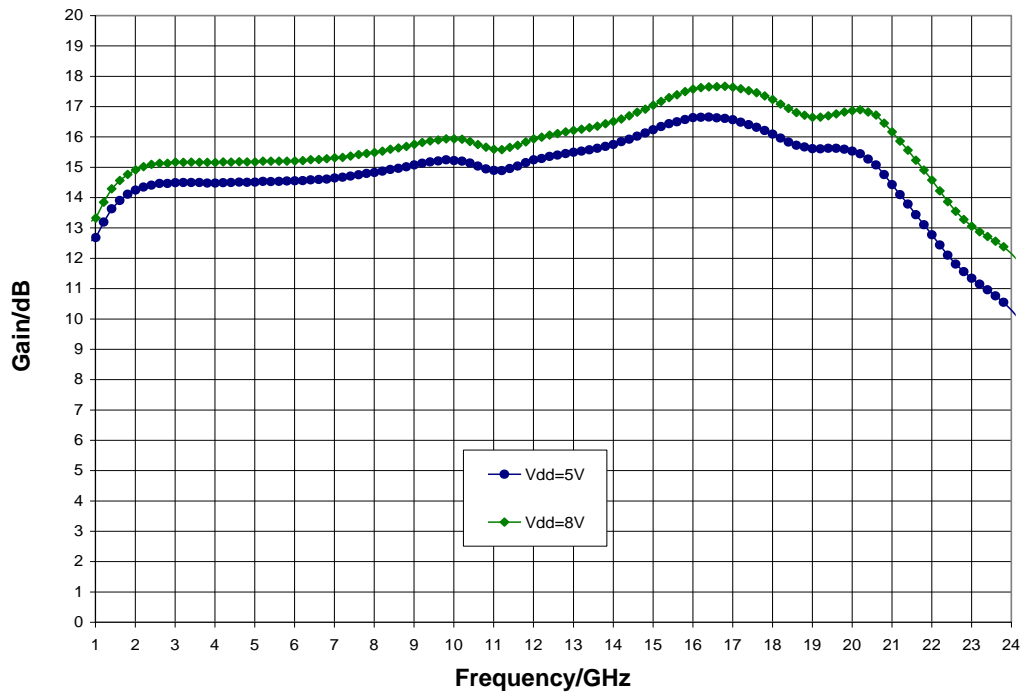

Typical Performance

Noise Figure vs. Temperature, $V_{dd} = 8.0\text{ V}$

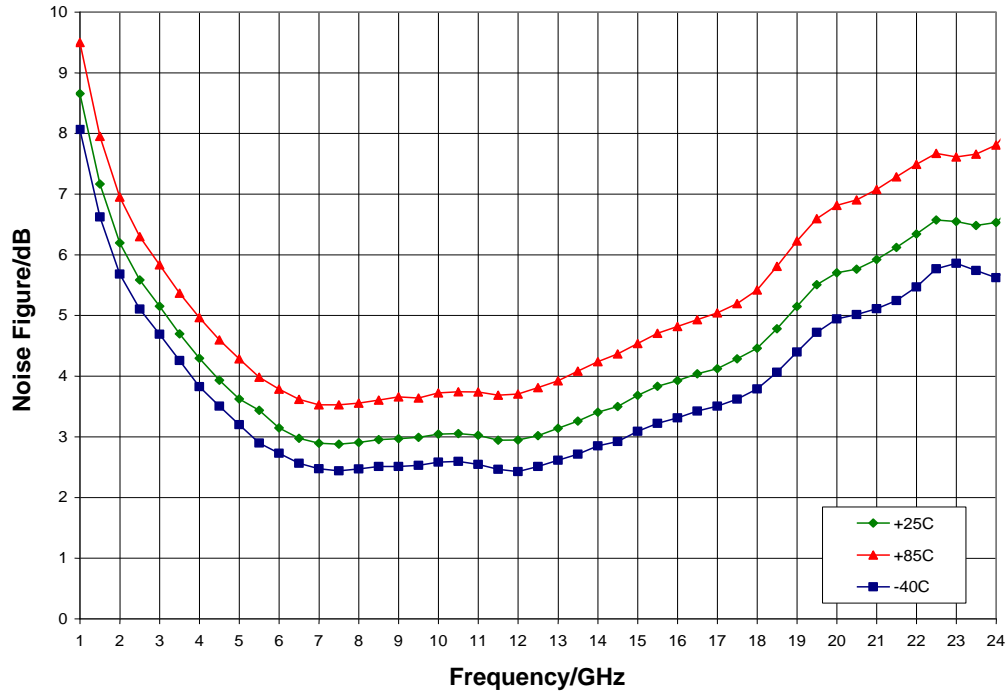

Noise Figure vs. V_{dd} , $T_A = 25^\circ\text{ C}$

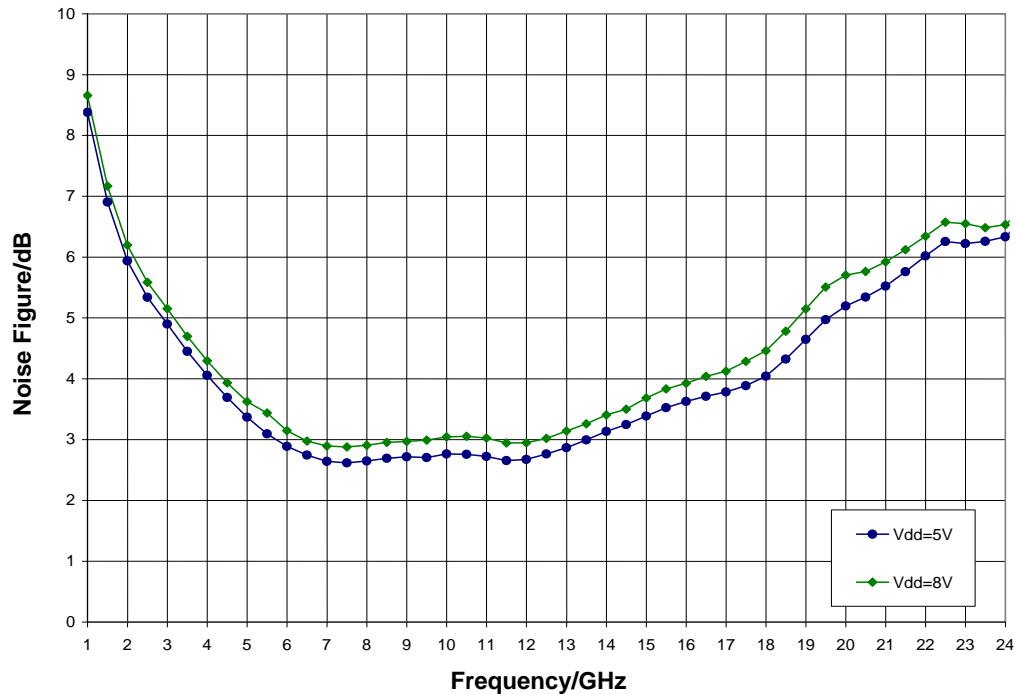

Typical Performance

P1dB vs. Temperature, $V_{dd} = 8.0\text{ V}$

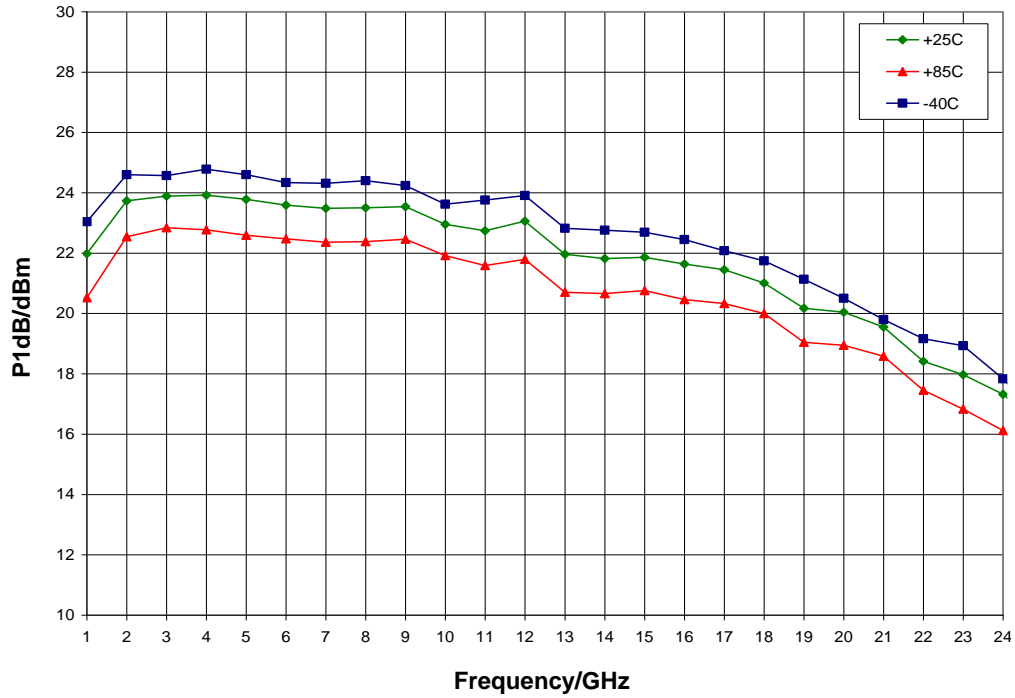

P1dB vs. V_{dd} , $T_A = 25^\circ\text{C}$

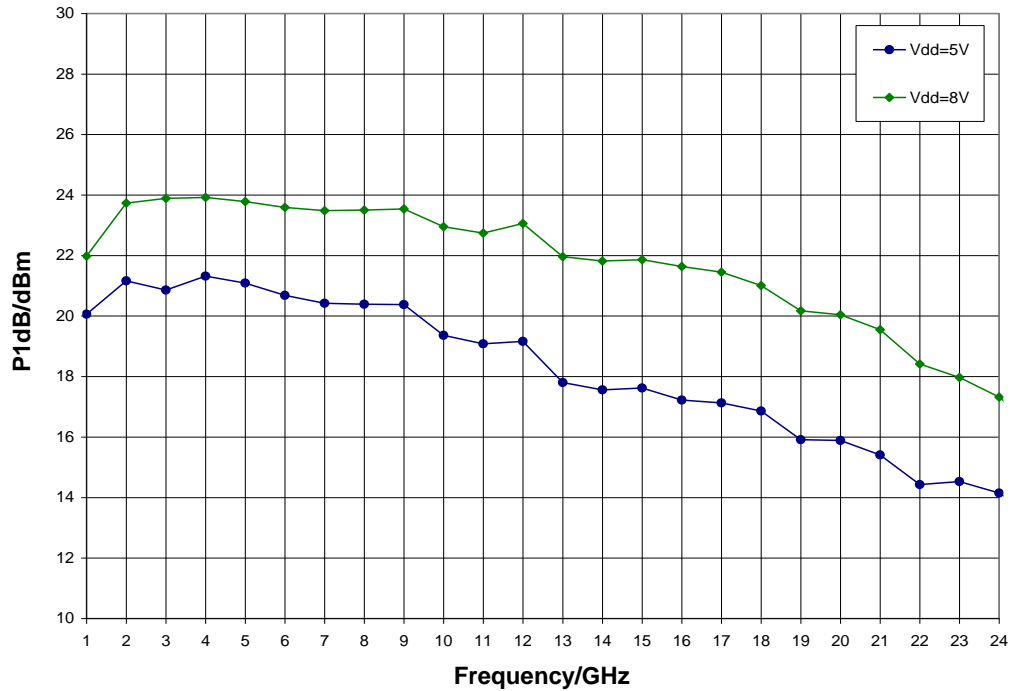

Typical Performance

Psat vs. Temperature, $V_{dd} = 8.0\text{ V}$

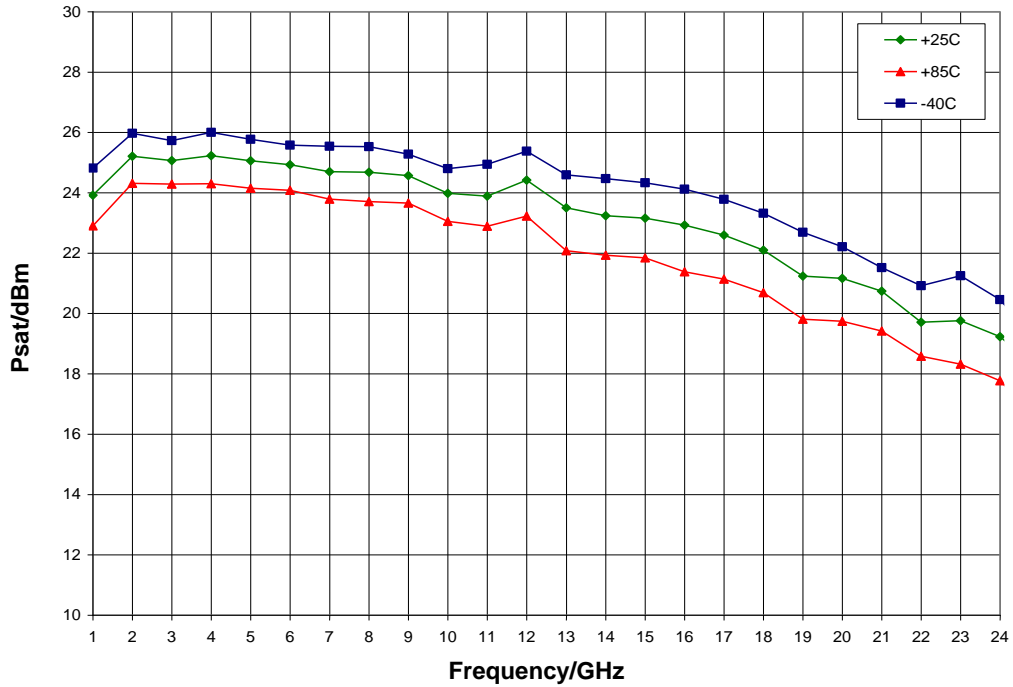

Psat vs. V_{dd} , $T_A = 25^\circ\text{ C}$

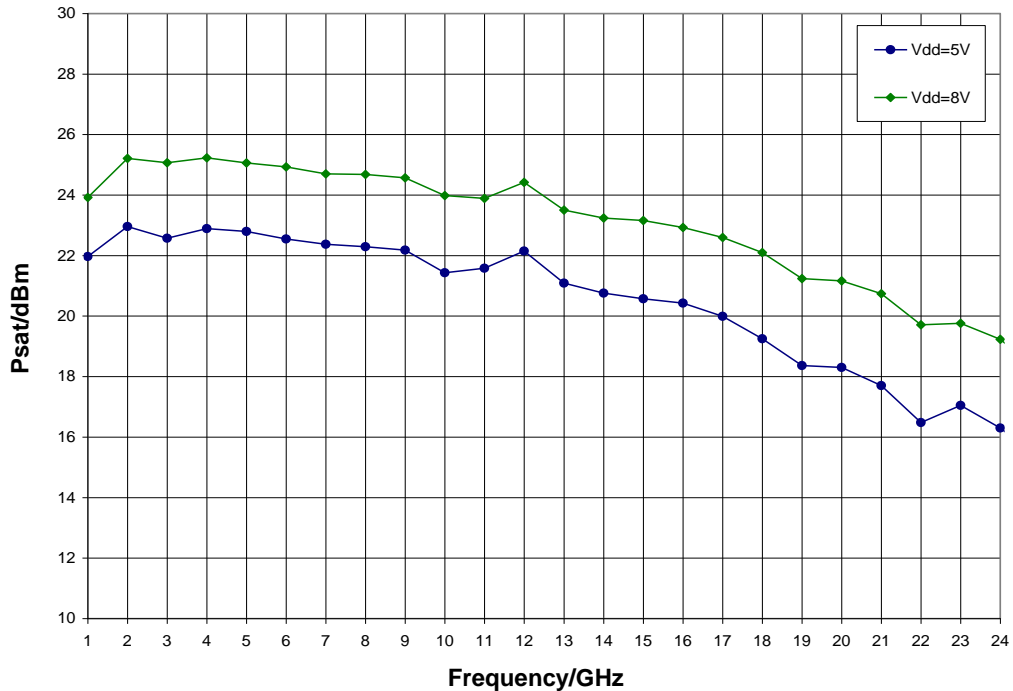

Typical Performance

Output IP3 vs. Temperature, $V_{dd} = 8.0\text{ V}$

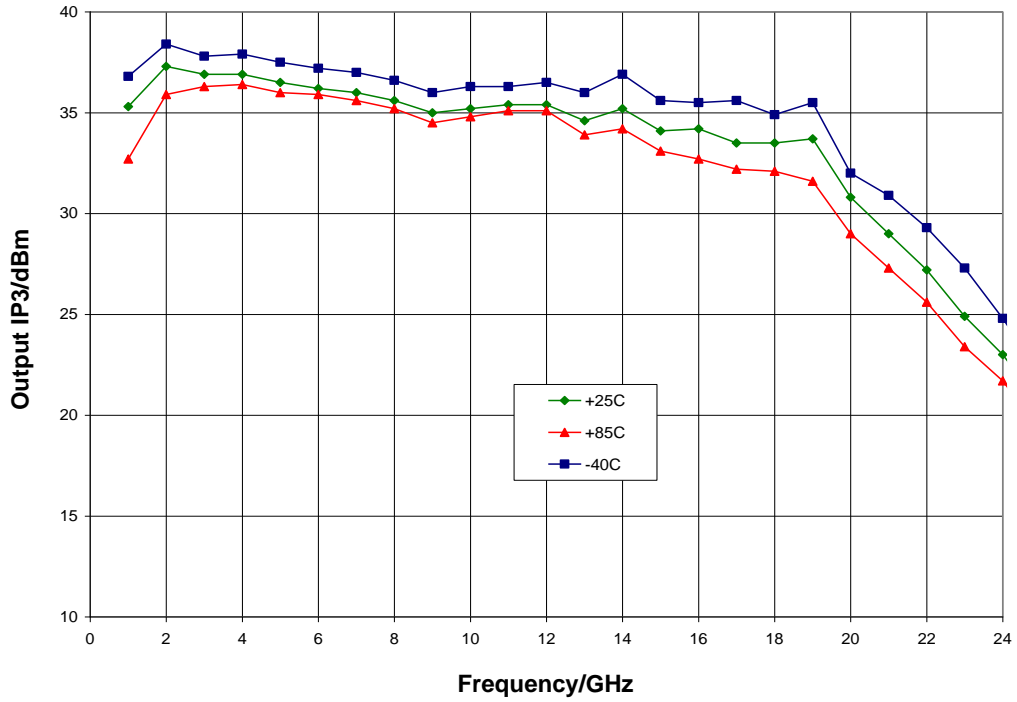

Output IP3 vs. V_{dd} , $T_A = 25^\circ\text{C}$

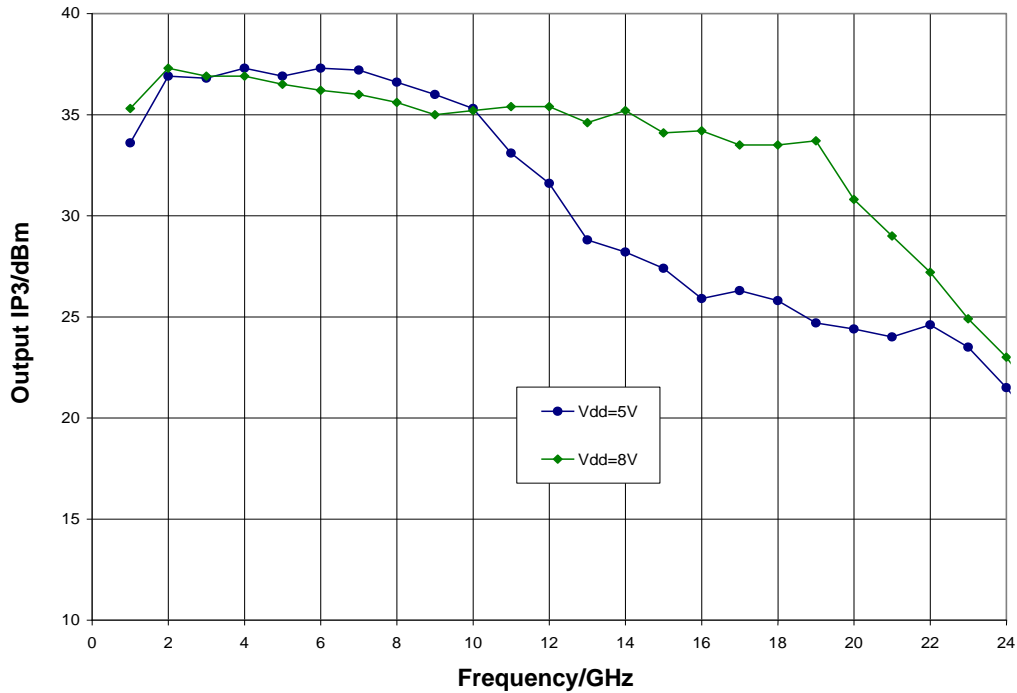

Typical Performance

Output IP2 vs. Temperature, $V_{dd} = 8.0\text{ V}$

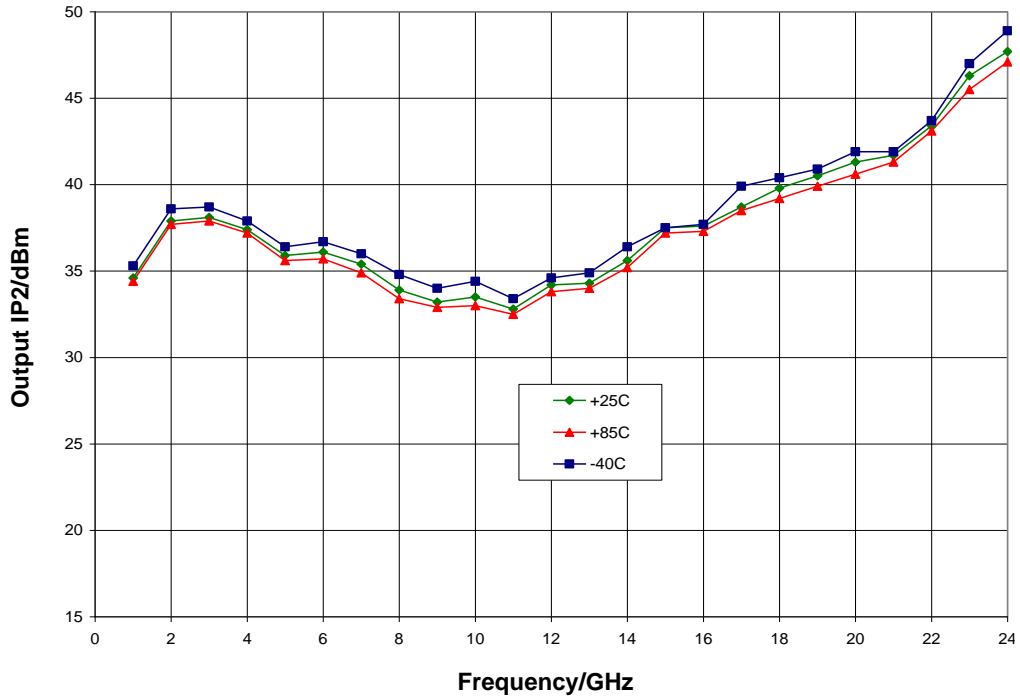

Output IP2 vs. V_{dd} , $T_A = 25^\circ\text{ C}$

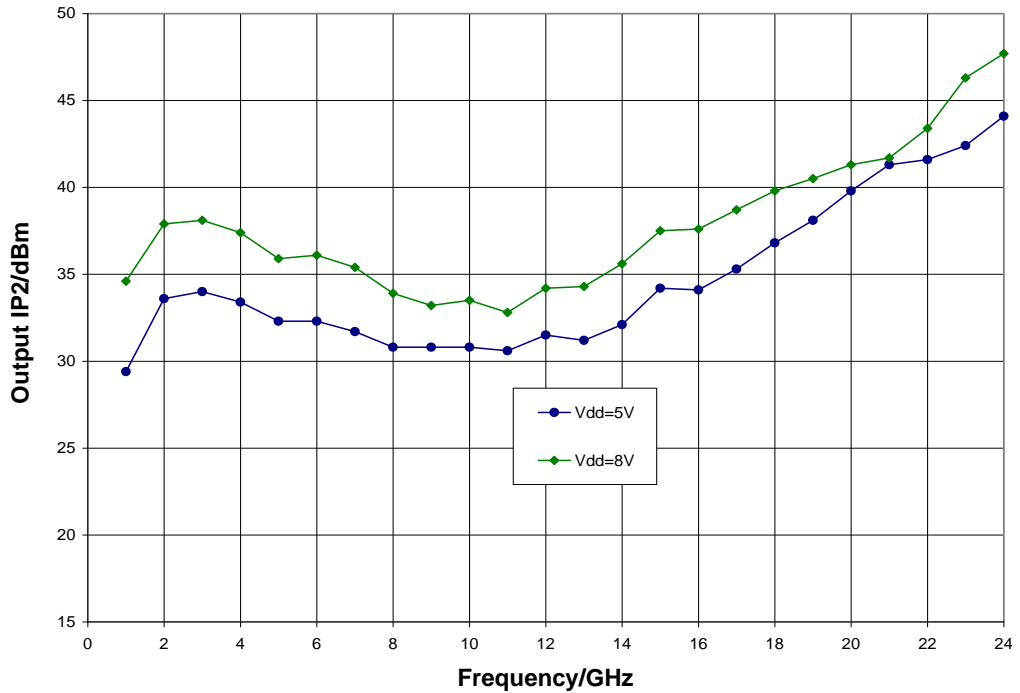

Mechanical Information

Package Information and Dimensions

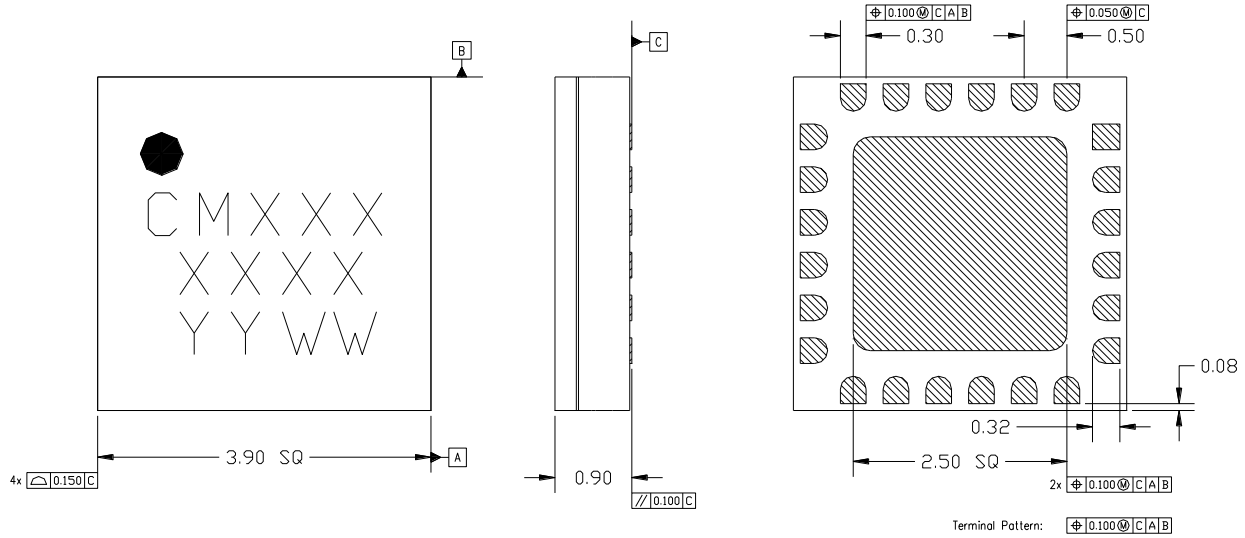

Notes:

1. All dimensions shown in mm.
2. Material: Black alumina
3. Lead finish
 - 3.1. Ni: 8.89um max, 1.27um min
 - 3.2. Pd: 0.17um max, 0.07um min
 - 3.3. Au: 0.254um max, 0.03um min
4. Marking
 - 4.1. Line 1: Part number
 - 4.1.1. Example: CMD191C4 shall be marked as CM191
 - 4.2. Line 2: Lot number
 - 4.3. Line 3: Date code - Last 2 digits of the year of manufacture followed by a 2 digit week code
5. Alternate pin #1 identifier is a single square pad
6. Alternate die paddle may have chamfered corners

Recommended PCB Land Pattern

Qorvo recommends that the user develop the land pattern that will provide the best design for proper solder reflow and device attach for their specific application. Please review Qorvo Application Note AN 105 for a recommended land pattern approach.

Recommended Solder Reflow Profile

Qorvo recommends screen printing with belt furnace reflow to ensure proper solder reflow and device attach. Please review Qorvo Application Note AN 102 for a recommended solder reflow profile.

Pin Description

Pin Diagram

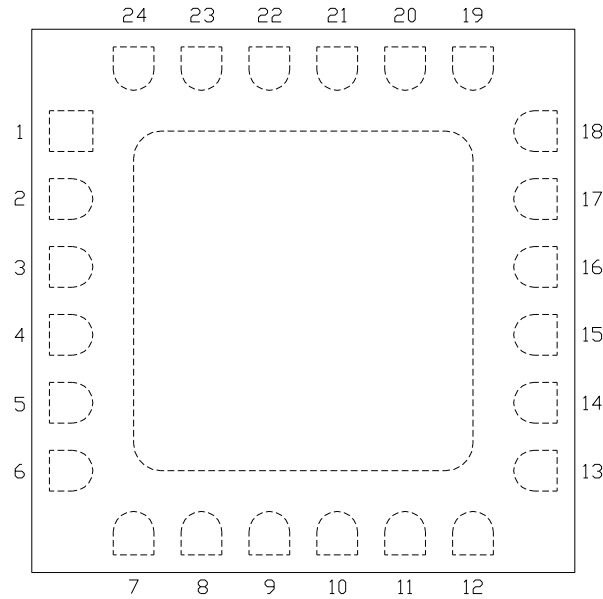

Functional Description

Pad	Function	Description	Schematic
1, 2, 6 - 9, 11 - 14, 18 - 22, 24	N/C	No connection required These pins may be connected to RF / DC ground	
3, 5, 15, 17 and die paddle	Ground	Connect to RF / DC ground	
4	RF in	50 ohm matched input External DC block required	
23	V _{dd}	Power supply voltage Decoupling and bypass caps required	
16	RF out	50 ohm matched input External DC block required	
10	ACG	Low frequency termination Attach bypass capacitor per application circuit	

Applications Information

Application Circuit

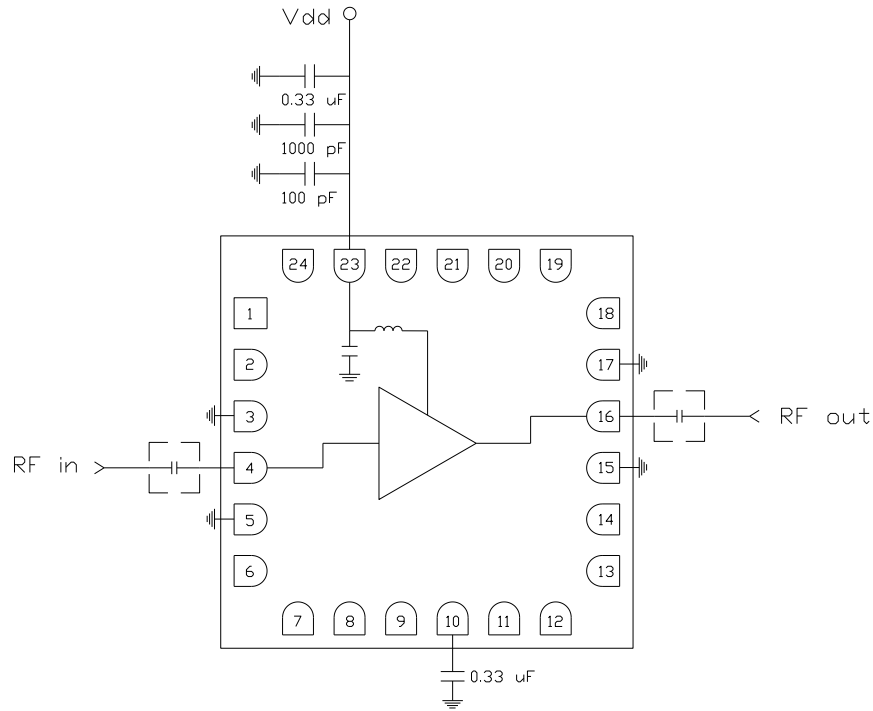

Biassing and Operation

The CMD317C4 is biased with a single positive drain supply. Performance is optimized when the drain voltage is set to +8.0 V.

Turn ON procedure:

1. Apply drain voltage V_{dd} and set to +8 V

Turn OFF procedure:

1. Turn off drain voltage V_{dd}

RF power can be applied at any time.

GaAs MMIC devices are susceptible to damage from Electrostatic Discharge. Proper precautions should be observed during handling, assembly and test.

Applications Information

Evaluation Board

The circuit board shown has been developed for optimized assembly at Qorvo. A sufficient number of via holes should be used to connect the top and bottom ground planes. As surface mount processes vary, careful process development is recommended.

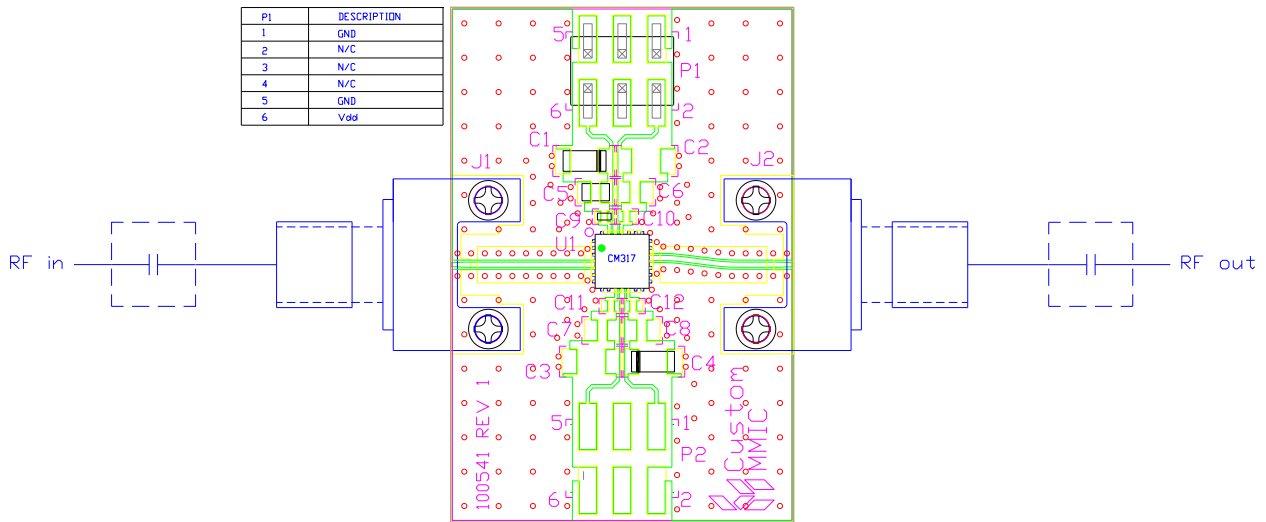

Bill of Material

Designator	Value	Description
J1, J2		SMA End Launch Connector
P1		6 Pin Header
C1, C4	0.33 μ F	Capacitor, Tantalum
C5	1000 pF	Capacitor, 0603
C9	100 pF	Capacitor, 0402
U1		CMD317C4 Driver Amplifier
PCB		100541 Evaluation PCB

RoHS Compliance

This part is compliant with 2011/65/EU RoHS directive (Restrictions on the Use of Certain Hazardous Substances in Electrical and Electronic Equipment) as amended by Directive 2015/863/EU.

This product also has the following attributes:

- Lead Free
- Antimony Free
- TBBP-A (C₁₅H₁₂Br₄O₂) Free
- SVHC Free
- PFOS Free
- Halogen Free



Contact Information

For the latest specifications, additional product information, worldwide sales and distribution locations:

Web: www.qorvo.com

Tel: 1-844-890-8163

Email: customer.support@qorvo.com

Important Notice

The information contained in this Data Sheet and any associated documents (“Data Sheet Information”) is believed to be reliable; however, Qorvo makes no warranties regarding the Data Sheet Information and assumes no responsibility or liability whatsoever for the use of said information. All Data Sheet Information is subject to change without notice. Customers should obtain and verify the latest relevant Data Sheet Information before placing orders for Qorvo® products. Data Sheet Information or the use thereof does not grant, explicitly, implicitly or otherwise any rights or licenses to any third party with respect to patents or any other intellectual property whether with regard to such Data Sheet Information itself or anything described by such information.

DATA SHEET INFORMATION DOES NOT CONSTITUTE A WARRANTY WITH RESPECT TO THE PRODUCTS DESCRIBED HEREIN, AND QORVO HEREBY DISCLAIMS ANY AND ALL WARRANTIES WITH RESPECT TO SUCH PRODUCTS WHETHER EXPRESS OR IMPLIED BY LAW, COURSE OF DEALING, COURSE OF PERFORMANCE, USAGE OF TRADE OR OTHERWISE, INCLUDING THE IMPLIED WARRANTIES OF MERCHANTABILITY AND FITNESS FOR A PARTICULAR PURPOSE. Without limiting the generality of the foregoing, Qorvo® products are not warranted or authorized for use as critical components in medical, life-saving, or life-sustaining applications, or other applications where a failure would reasonably be expected to cause severe personal injury or death. Applications described in the Data Sheet Information are for illustrative purposes only. Customers are responsible for validating that a particular product described in the Data Sheet Information is suitable for use in a particular application.

© 2020 Qorvo US, Inc. All rights reserved. This document is subject to copyright laws in various jurisdictions worldwide and may not be reproduced or distributed, in whole or in part, without the express written consent of Qorvo US, Inc. | QORVO® is a registered trademark of Qorvo US, Inc.

X-ON Electronics

Largest Supplier of Electrical and Electronic Components

Click to view similar products for [RF Amplifier](#) category:

Click to view products by [Qorvo](#) manufacturer:

Other Similar products are found below :

[A82-1](#) [BGA622H6820XTSA1](#) [BGA 728L7 E6327](#) [BGB719N7ESDE6327XTMA1](#) [HMC397-SX](#) [HMC405](#) [HMC561-SX](#) [HMC8120-SX](#)
[HMC8121-SX](#) [HMC-ALH382-SX](#) [HMC-ALH476-SX](#) [SE2433T-R](#) [SMA3101-TL-E](#) [SMA39](#) [A66-1](#) [A66-3](#) [A67-1](#) [LX5535LQ](#) [LX5540LL](#)
[MAAM02350](#) [HMC3653LP3BETR](#) [HMC549MS8GETR](#) [HMC-ALH435-SX](#) [SMA101](#) [SMA32](#) [SMA411](#) [SMA531](#) [SST12LP17E-XX8E](#)
[SST12LP19E-QX6E](#) [WPM0510A](#) [HMC5929LS6TR](#) [HMC5879LS7TR](#) [HMC1126](#) [HMC1087F10](#) [HMC1086](#) [HMC1016](#) [SMA1212](#)
[MAX2689EWS+T](#) [MAAMSS0041TR](#) [MAAM37000-A1G](#) [LTC6430AIUF-15#PBF](#) [CHA5115-QDG](#) [SMA70-2](#) [SMA4011](#) [A231](#) [HMC-](#)
[AUH232](#) [LX5511LQ](#) [LX5511LQ-TR](#) [HMC7441-SX](#) [HMC-ALH310](#)