

### Product Overview

The CMD318P3 is a broadband MMIC low noise amplifier housed in a leadless 3x3 mm plastic surface mount package. The CMD318P3 is ideally suited for microwave radios and C and X-band applications where small size and low power consumption are needed. The broadband device delivers 22 dB of gain with a corresponding output 1 dB compression point of +14 dBm and a noise figure of 1.25 dB at 8 GHz. The CMD318P3 is a 50 ohm matched design eliminating the need for external DC blocks and RF port matching.

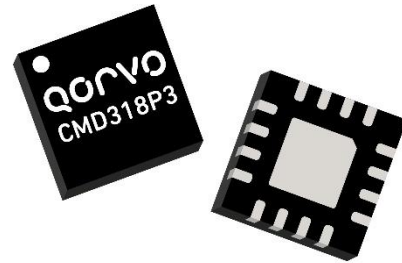

### Functional Block Diagram

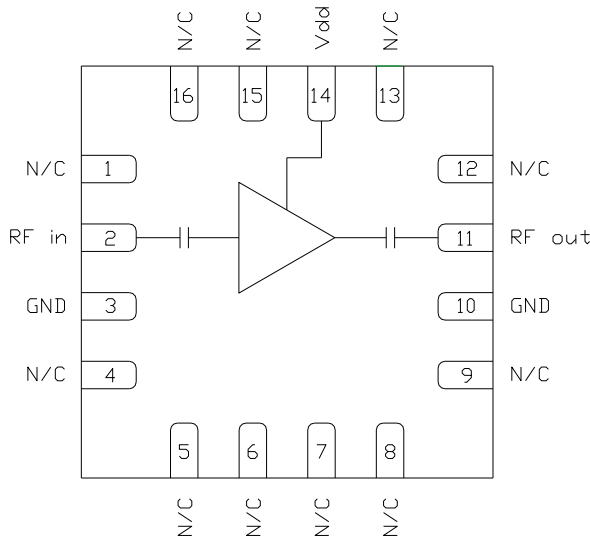

### Key Features

- Ultra Low Noise Figure
- Low Current Consumption
- High Gain Broadband Performance
- Single Positive Supply Voltage
- Pb-Free RoHs Compliant 3x3 QFN Package

### Ordering Information

Part No.	Description
CMD318P3	100 pcs on 7" reel
CMD318P3-EVB	Evaluation Board

### Electrical Performance ( $V_{dd} = 3.6\text{ V}$ , $T_A = 25^\circ\text{C}$ , $F = 8\text{ GHz}$ )

Parameter	Min	Typ	Max	Units
Frequency Range		5 - 9		GHz
Gain		22		dB
Noise Figure		1.25		dB
Input Return Loss		11		dB
Output Return Loss		25		dB
Output P1dB		14		dBm
Output IP3		25.5		dBm
Supply Current		33		mA

## Absolute Maximum Ratings

Parameter	Rating
Drain Voltage, $V_{dd}$	5.0 V
RF Input Power	+20 dBm
Channel Temperature, $T_{ch}$	150° C
Power Dissipation, $P_{diss}$	390 mW
Thermal Resistance, $Q_{JC}$	165 °C/W
Operating Temperature	-40 to 85° C
Storage Temperature	-55 to 150° C

Exceeding any one or combination of the maximum ratings may cause permanent damage to the device.

## Recommended Operating Conditions

Parameter	Min	Typ	Max	Units
$V_{dd}$	2.5	3.6	4.5	V
$I_{dd}$		33		mA

Electrical performance is measured at specific test conditions. Electrical specifications are not guaranteed over all recommended operating conditions.

## Drain Current vs. Drain Voltage

$V_{dd}$ (V)	$I_{dd}$ (mA)
2.5	22
3.6	33
4.5	42

## Electrical Specifications ( $V_{dd} = 3.6$ V, $T_A = 25^\circ$ C)

Parameter	Min	Typ	Max	Min	Typ	Max	Units
Frequency Range		5 - 9			7.2 - 8.4		GHz
Gain	18	22.5		18.5	22		dB
Noise Figure		1.25	2		1.25	1.7	dB
Input Return Loss		11			12		dB
Output Return Loss		18			25		dB
Output P1dB		13			14		dBm
Output IP3		25			25.5		dBm
Supply Current	23	33	43	23	33	43	mA
Gain Temperature Coefficient		0.016			0.016		dB/°C
Noise Figure Temperature Coefficient		0.006			0.006		dB/°C

Typical Performance

Broadband Performance,  $V_{dd} = 3.6\text{ V}$ ,  $T_A = 25^\circ\text{ C}$

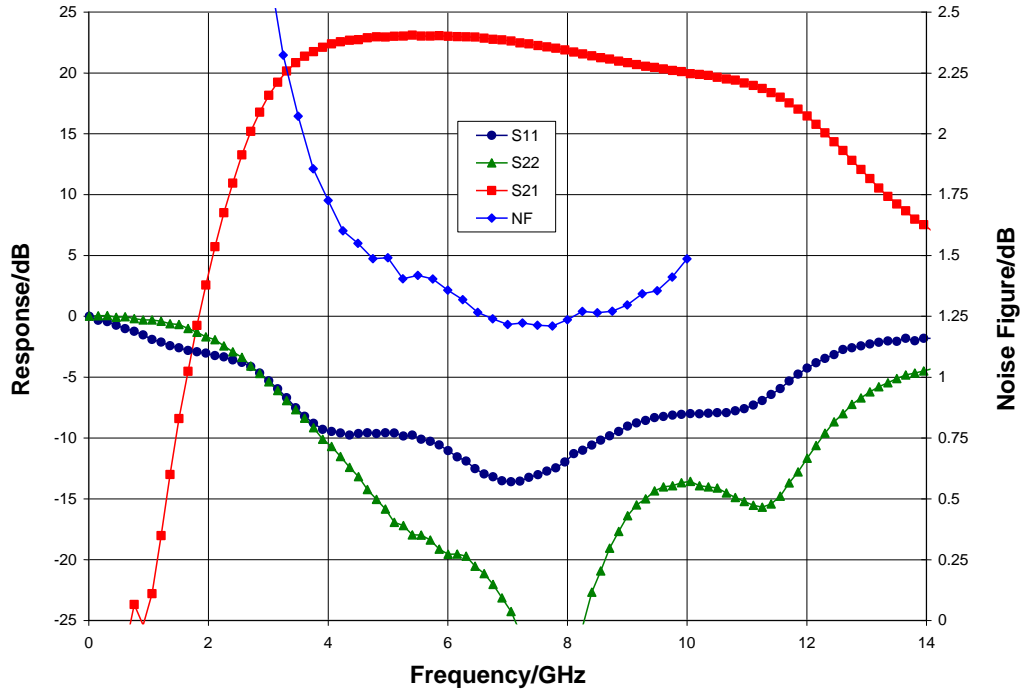

Narrow-band Performance,  $V_{dd} = 3.6\text{ V}$ ,  $T_A = 25^\circ\text{ C}$

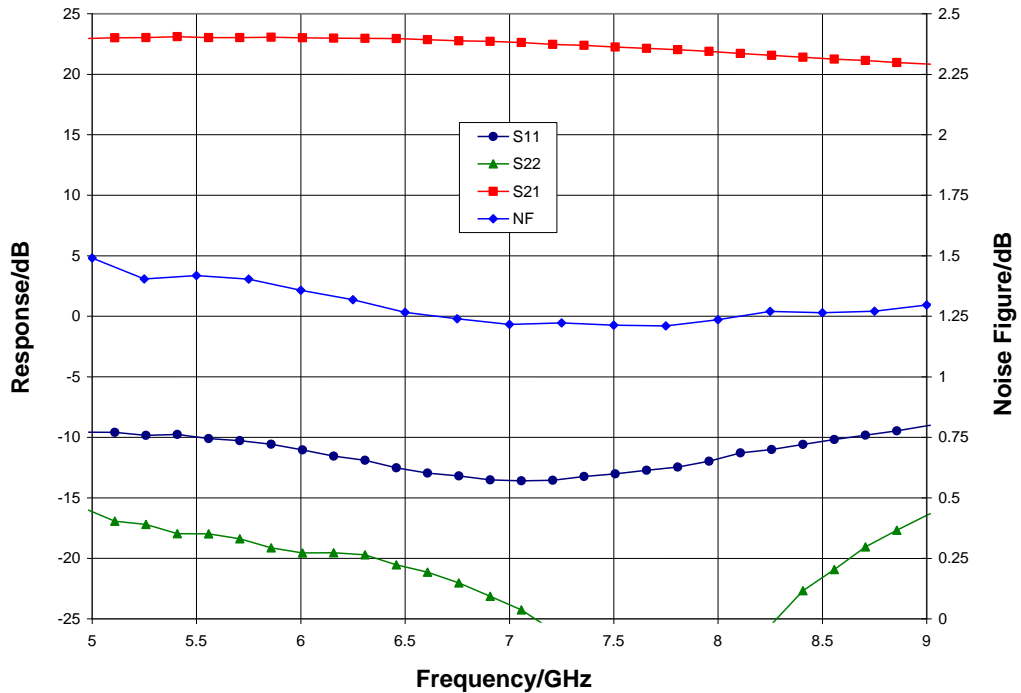

Typical Performance

Gain vs. Temperature,  $V_{dd} = 3.6\text{ V}$

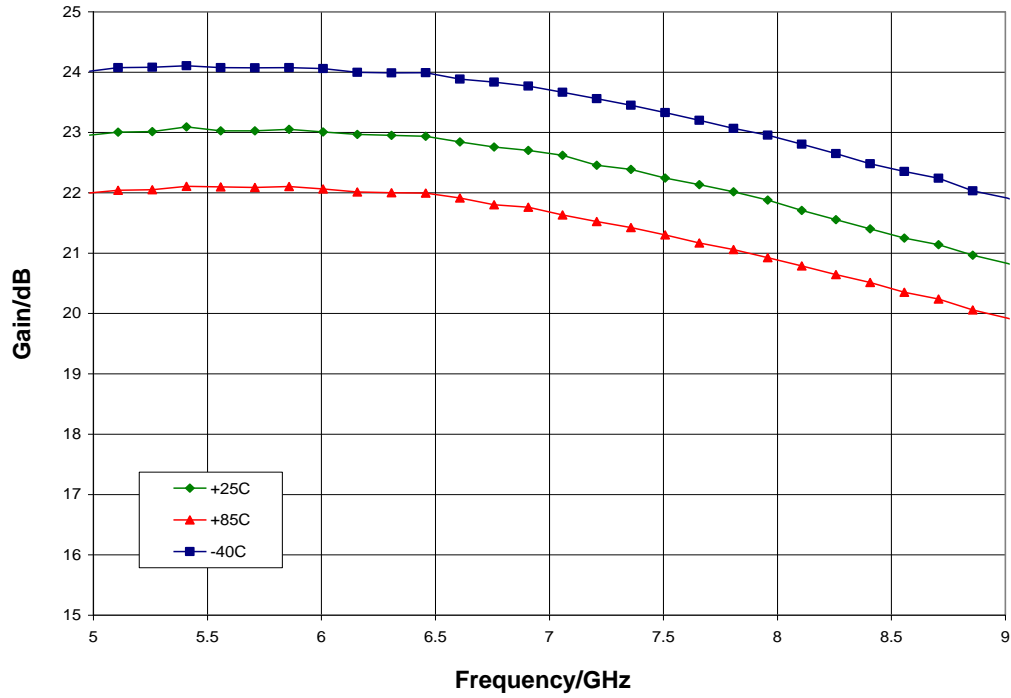

Gain vs.  $V_{dd}$ ,  $T_A = 25^\circ\text{ C}$

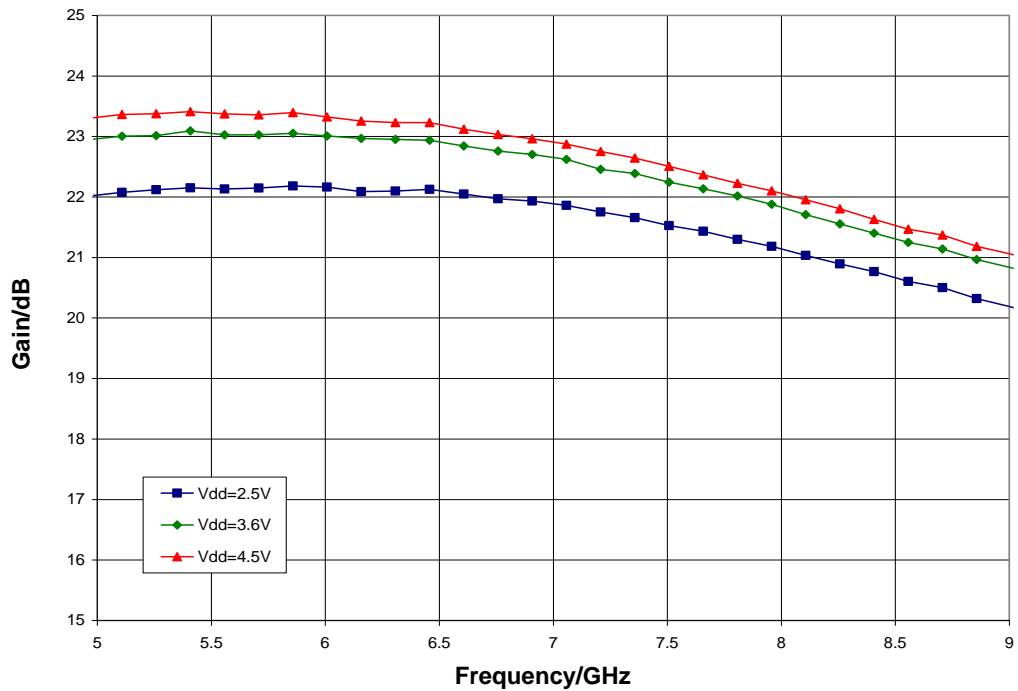

Typical Performance

Noise Figure vs. Temperature,  $V_{dd} = 3.6\text{ V}$

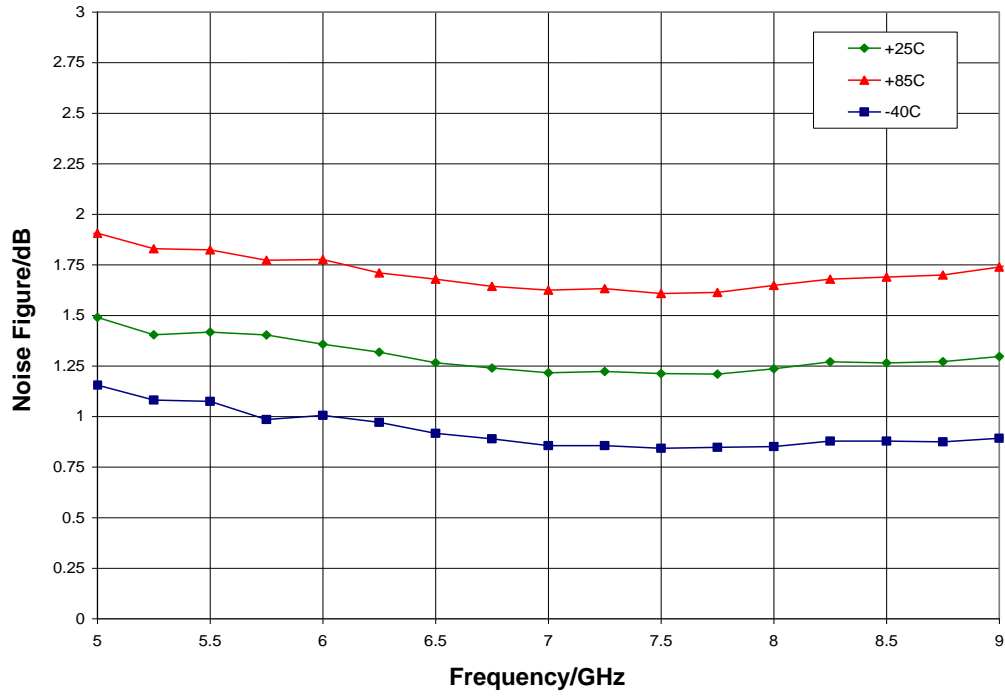

Noise Figure vs.  $V_{dd}$ ,  $T_A = 25^\circ\text{ C}$

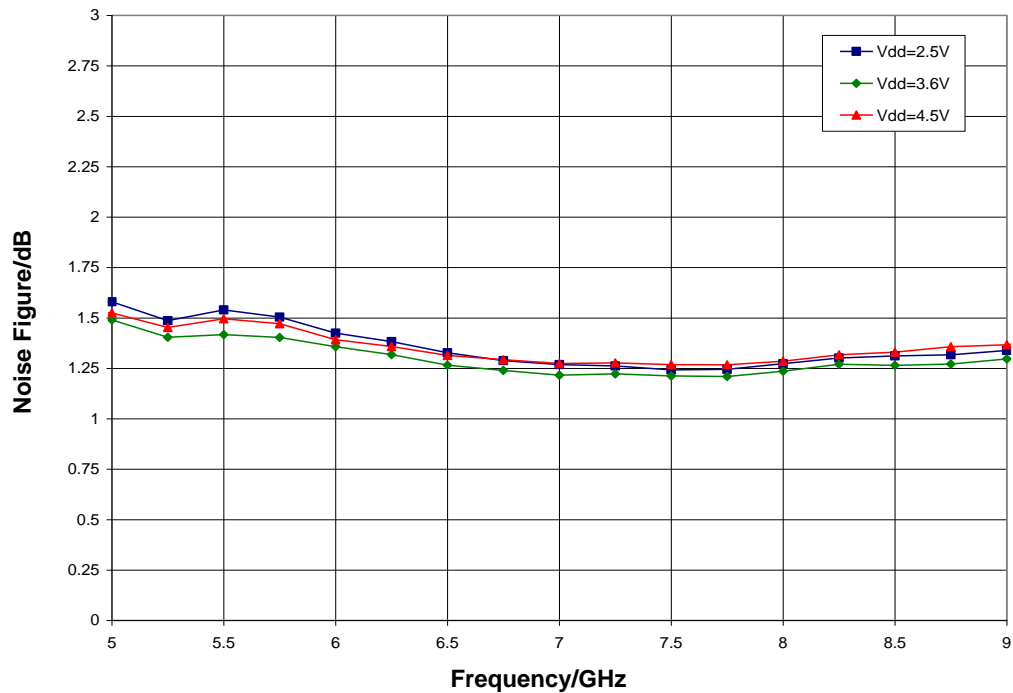

Typical Performance

P1dB vs. Temperature,  $V_{dd} = 3.6\text{ V}$

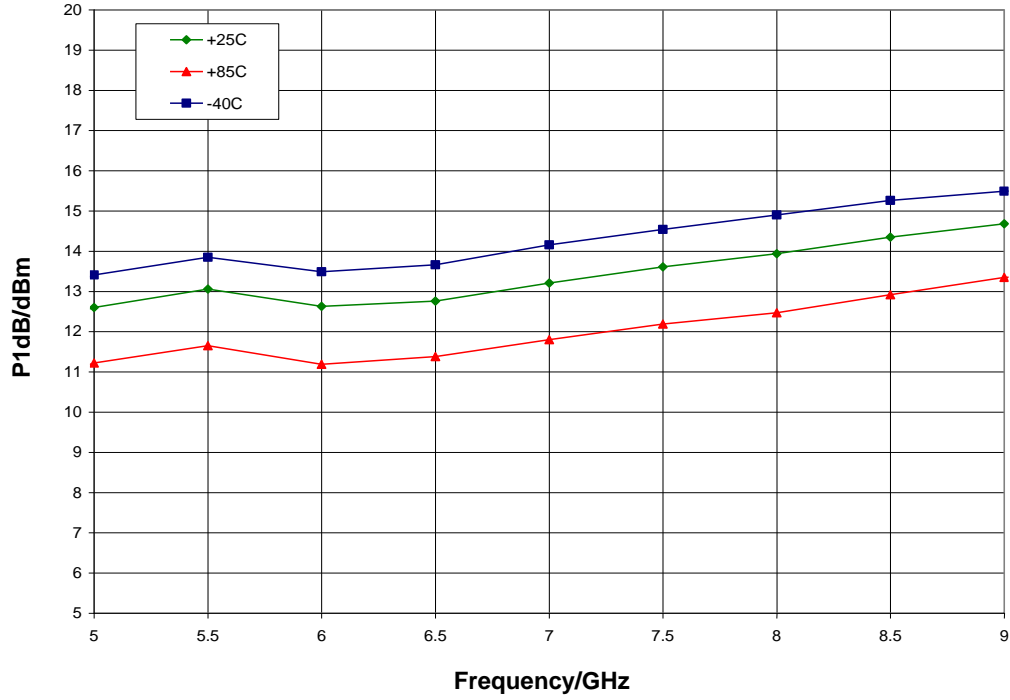

P1dB vs.  $V_{dd}$ ,  $T_A = 25^\circ\text{ C}$

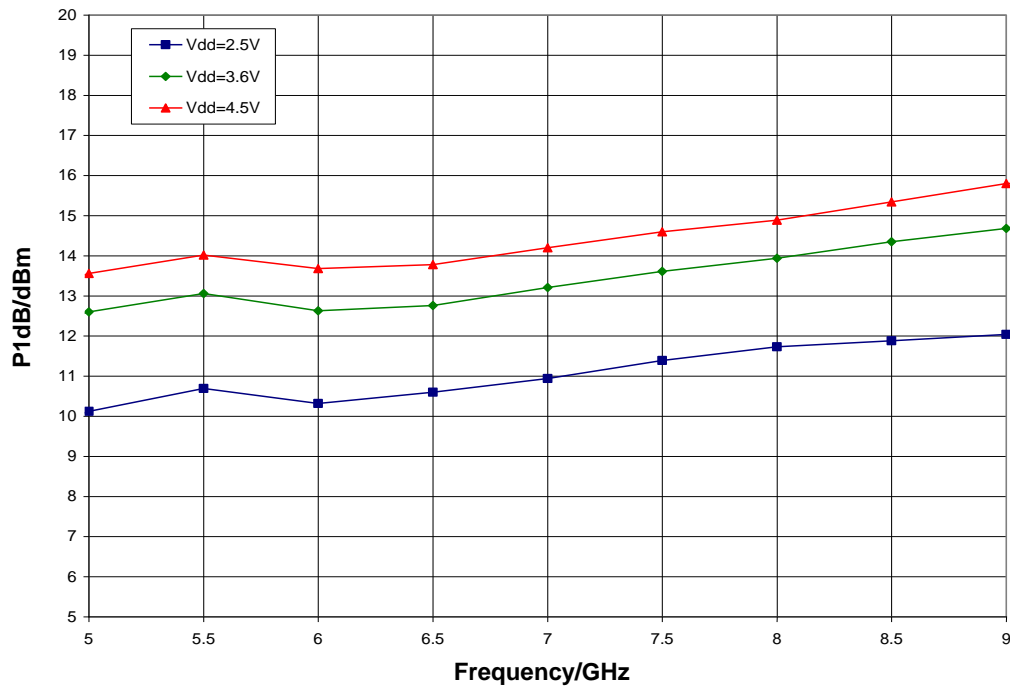

Typical Performance

Psat vs. Temperature, V<sub>dd</sub> = 3.6 V

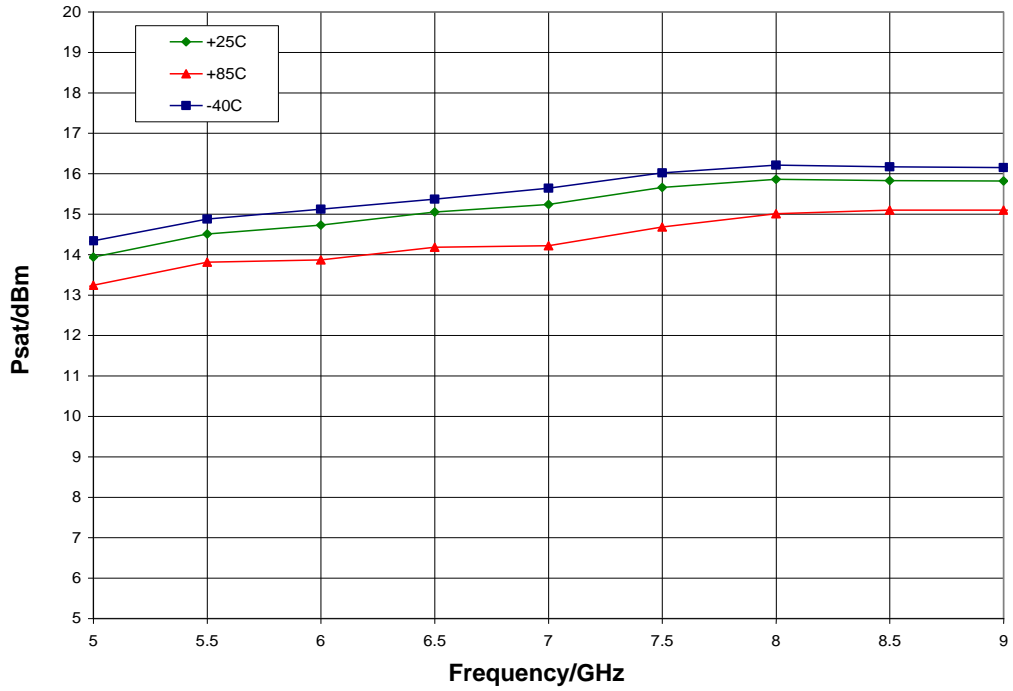

Psat vs. V<sub>dd</sub>, T<sub>A</sub> = 25° C

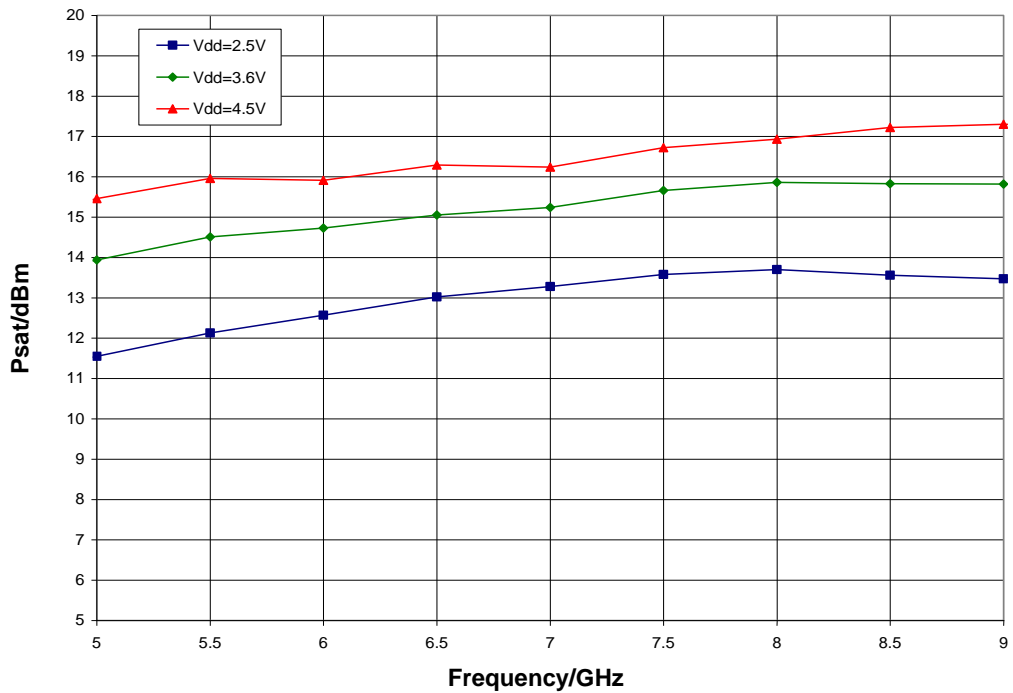

Typical Performance

Output IP3 vs. Temperature,  $V_{dd} = 3.6\text{ V}$

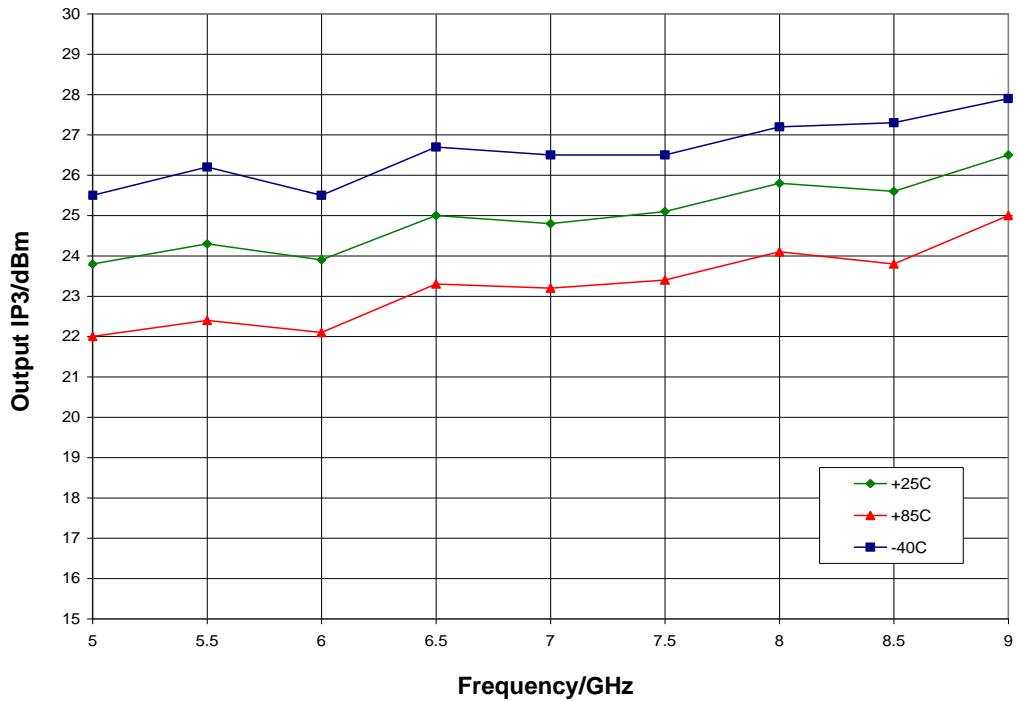

Output IP3 vs.  $V_{dd}$ ,  $T_A = 25^\circ\text{C}$

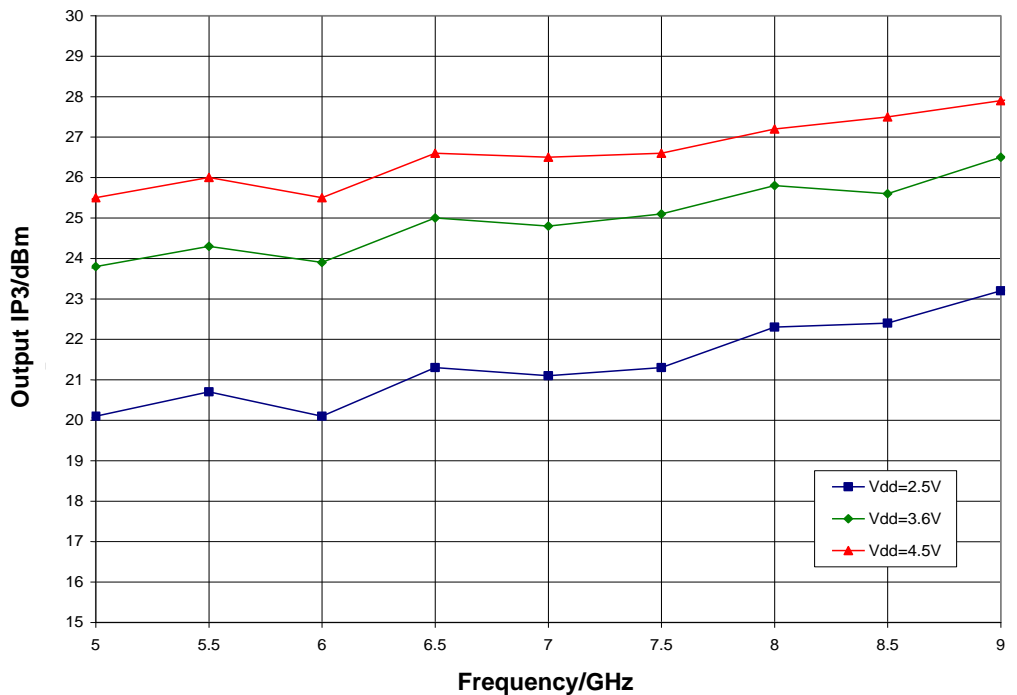



**Mechanical Information**

**Package Information and Dimensions**

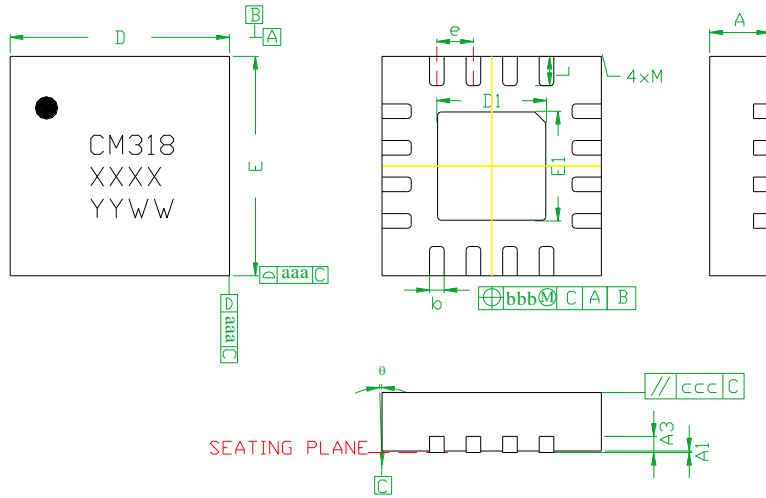

SYMBOLS	DIMENSIONS IN MILLIMETERS		
	MIN	NOM	MAX
A	0.80	0.90	1.00
A1	0	0.02	0.05
A3	---	0.25REF.	---
b	0.18	0.23	0.30
D	2.85	3.00	3.15
D1	---	1.5BSC	---
E	2.85	3.00	3.15
E1	---	1.5BSC	---
e	---	0.50BSC	---
L	0.30	0.40	0.50
θ	0	---	12
aaa	---	0.25	---
bbb	---	0.10	---
ccc	---	0.10	---
M	---	---	0.05

**Notes:**

1. Dimensions are in millimeters
2. RoHs compliant mold compound
3. Lead frame material: Copper alloy
4. Lead finish: 100% matte Sn
5. Indicated dimension/tolerance applies to leads and exposed pad

**Recommended PCB Land Pattern**

Qorvo recommends that the user develop the land pattern that will provide the best design for proper solder reflow and device attach for their specific application. Please review Qorvo Application Note AN 105 for a recommended land pattern approach.

**Recommended Solder Reflow Profile**

Qorvo recommends screen printing with belt furnace reflow to ensure proper solder reflow and device attach. Please review Qorvo Application Note AN 102 for a recommended solder reflow profile.

## Pin Description

### Pin Diagram

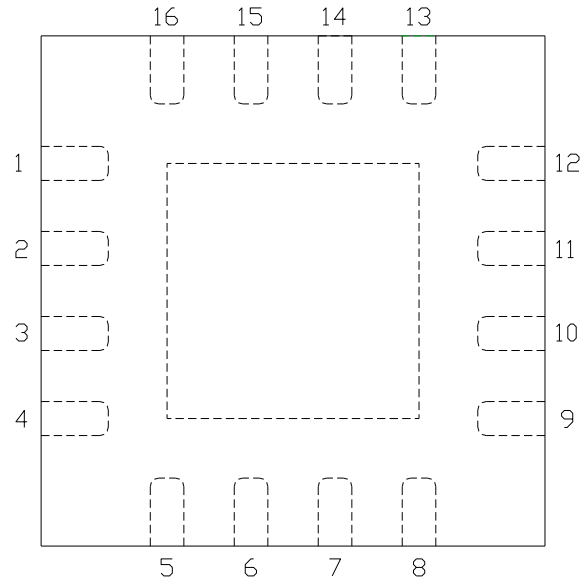

### Functional Description

Pin	Function	Description	Schematic
1, 4 - 9, 12, 13, 15, 16	N/C	No connection required These pins may be connected to RF / DC ground	
2	RF in	DC blocked and 50 ohm matched	
3, 10, and die paddle	Ground	Connect to RF / DC ground	
11	RF out	DC blocked and 50 ohm matched	
14	V <sub>dd</sub>	Power supply voltage Decoupling and bypass caps required	

**Applications Information**

**Application Circuit**

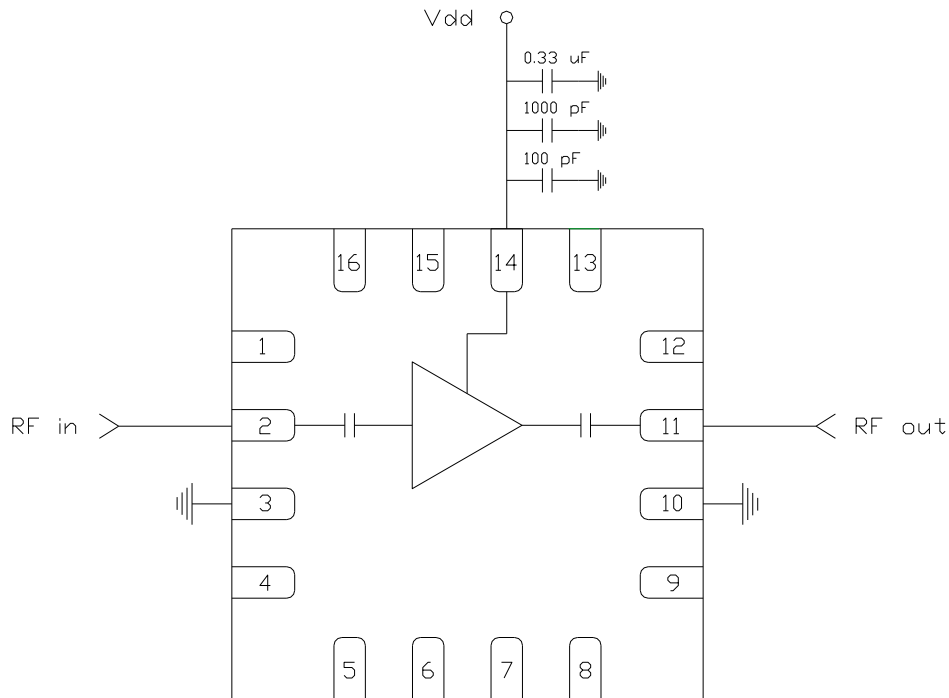

**Biasing and Operation**

The CMD318P3 is biased with a single 3.6 V positive drain supply.

RF power can be applied at any time.

**GaAs MMIC devices are susceptible to damage from Electrostatic Discharge. Proper precautions should be observed during handling, assembly and test.**

## Applications Information

### Evaluation Board

The circuit board shown has been developed for optimized assembly at Qorvo. A sufficient number of via holes should be used to connect the top and bottom ground planes. As surface mount processes vary, careful process development is recommended.

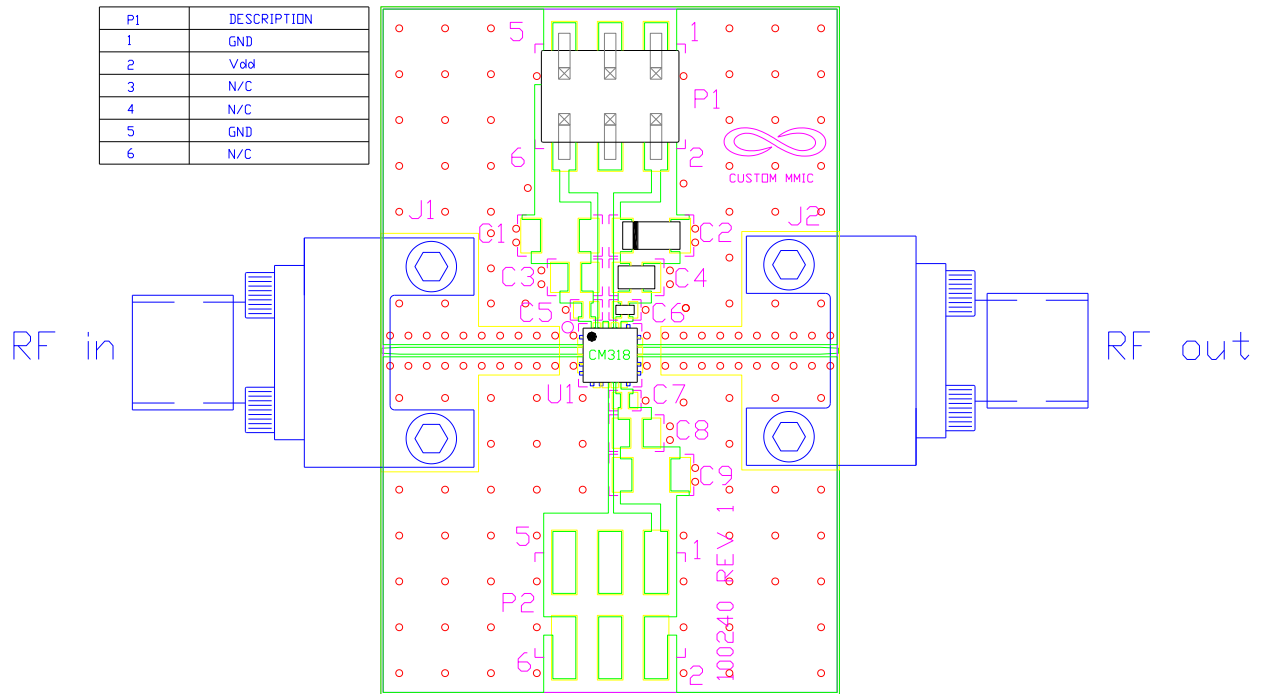

### Bill of Material

Designator	Value	Description
J1, J2		SMA End Launch Connector
P1		6 Pin Header
C2	0.33 $\mu$ F	Capacitor, Tantalum
C4	1000 pF	Capacitor, 0603
C6	100 pF	Capacitor, 0402
U1		CMD318P3 Low Noise Amplifier
PCB		100240 Evaluation PCB

## Handling Precautions

Parameter	Rating	Standard
ESD – Human Body Model (HBM)	Class 1A	ESDA / JEDEC JS-001-2012
MSL – Moisture Sensitivity Level	Level 1	JEDEC standard IPC/JEDEC J-STD-020



Caution!  
ESD-Sensitive Device

## RoHS Compliance

This part is compliant with 2011/65/EU RoHS directive (Restrictions on the Use of Certain Hazardous Substances in Electrical and Electronic Equipment) as amended by Directive 2015/863/EU.

This product also has the following attributes:

- Lead Free
- Antimony Free
- TBBP-A (C<sub>15</sub>H<sub>12</sub>Br<sub>4</sub>O<sub>2</sub>) Free
- SVHC Free
- PFOS Free
- Halogen Free



## Contact Information

For the latest specifications, additional product information, worldwide sales and distribution locations:

**Web:** [www.qorvo.com](http://www.qorvo.com)

**Tel:** 1-844-890-8163

**Email:** [customer.support@qorvo.com](mailto:customer.support@qorvo.com)

## Important Notice

The information contained in this Data Sheet and any associated documents (“Data Sheet Information”) is believed to be reliable; however, Qorvo makes no warranties regarding the Data Sheet Information and assumes no responsibility or liability whatsoever for the use of said information. All Data Sheet Information is subject to change without notice.

Customers should obtain and verify the latest relevant Data Sheet Information before placing orders for Qorvo® products. Data Sheet Information or the use thereof does not grant, explicitly, implicitly or otherwise any rights or licenses to any third party with respect to patents or any other intellectual property whether with regard to such Data Sheet Information itself or anything described by such information.

DATA SHEET INFORMATION DOES NOT CONSTITUTE A WARRANTY WITH RESPECT TO THE PRODUCTS DESCRIBED HEREIN, AND QORVO HEREBY DISCLAIMS ANY AND ALL WARRANTIES WITH RESPECT TO SUCH PRODUCTS WHETHER EXPRESS OR IMPLIED BY LAW, COURSE OF DEALING, COURSE OF PERFORMANCE, USAGE OF TRADE OR OTHERWISE, INCLUDING THE IMPLIED WARRANTIES OF MERCHANTABILITY AND FITNESS FOR A PARTICULAR PURPOSE. Without limiting the generality of the foregoing, Qorvo® products are not warranted or authorized for use as critical components in medical, life-saving, or life-sustaining applications, or other applications where a failure would reasonably be expected to cause severe personal injury or death. Applications described in the Data Sheet Information are for illustrative purposes only. Customers are responsible for validating that a particular product described in the Data Sheet Information is suitable for use in a particular application.

© 2020 Qorvo US, Inc. All rights reserved. This document is subject to copyright laws in various jurisdictions worldwide and may not be reproduced or distributed, in whole or in part, without the express written consent of Qorvo US, Inc. | QORVO® is a registered trademark of Qorvo US, Inc.

## X-ON Electronics

Largest Supplier of Electrical and Electronic Components

*Click to view similar products for [RF Amplifier](#) category:*

*Click to view products by [Qorvo](#) manufacturer:*

Other Similar products are found below :

[A82-1](#) [BGA622H6820XTSA1](#) [BGA 728L7 E6327](#) [BGB719N7ESDE6327XTMA1](#) [HMC397-SX](#) [HMC405](#) [HMC561-SX](#) [HMC8120-SX](#)  
[HMC8121-SX](#) [HMC-ALH382-SX](#) [HMC-ALH476-SX](#) [SE2433T-R](#) [SMA3101-TL-E](#) [SMA39](#) [A66-1](#) [A66-3](#) [A67-1](#) [LX5535LQ](#) [LX5540LL](#)  
[MAAM02350](#) [HMC3653LP3BETR](#) [HMC549MS8GETR](#) [HMC-ALH435-SX](#) [SMA101](#) [SMA32](#) [SMA411](#) [SMA531](#) [SST12LP19E-QX6E](#)  
[WPM0510A](#) [HMC5929LS6TR](#) [HMC5879LS7TR](#) [HMC1126](#) [HMC1087F10](#) [HMC1086](#) [HMC1016](#) [SMA1212](#) [MAX2689EWS+T](#)  
[MAAMSS0041TR](#) [MAAM37000-A1G](#) [LTC6430AIUF-15#PBF](#) [CHA5115-QDG](#) [SMA70-2](#) [SMA4011](#) [A231](#) [HMC-AUH232](#) [LX5511LQ](#)  
[LX5511LQ-TR](#) [HMC7441-SX](#) [HMC-ALH310](#) [XD1001-BD-000V](#)