

Product Description

Qorvo's QPA1003D is a wideband high power MMIC amplifier fabricated on Qorvo's production 0.15um GaN on SiC process (QGaN15). The QPA1003D operates from 1 – 8 GHz and typically provides 10 W saturated output power with power-added efficiency of 30% and large-signal gain of 25 dB. This combination of wideband performance provides the flexibility designers are looking for to improve system performance while reducing size and cost.

The QPA1003D is matched to 50Ω with integrated DC blocking capacitors on both RF I/O ports simplifying system integration. The wideband performance makes it ideally suited in support of test instrumentation and electronic warfare, as well as, supporting multiple radar and communication bands.

The QPA1003D is 100% DC and RF tested on-wafer to ensure compliance to electrical specifications.

Lead-free and RoHS compliant.

Functional Block Diagram

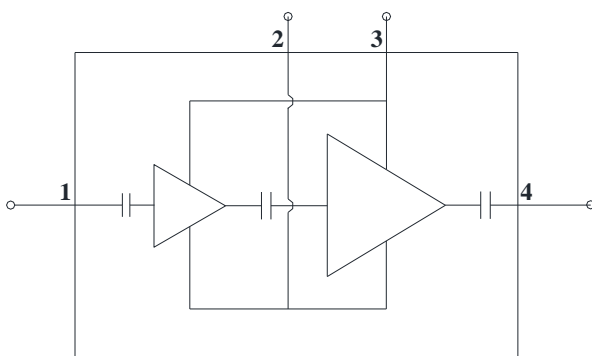

Product Features

- Frequency Range: 1 – 8 GHz
- P_{OUT}: 40 dBm @ P_{IN} = 15 dBm
- PAE: 30 % @ P_{IN} = 15 dBm
- Large Signal Gain: 25 dB @ P_{IN} = 15dBm
- Small Signal Gain: 30 dB
- Bias: V_D = +28 V, I_{DQ} = 650 mA
- Chip Dimensions: 3.3 x 3.55 x 0.10 mm
- Process Technology: QGaN15

Performance is typical across frequency. Please reference electrical specification table and data plots for more details.

Applications

- Electronic Warfare (EW)
- Radar
- Communications
- Test Instrumentation

Ordering Information

Part No.	Description
QPA1003D	1 – 8 GHz 10 W GaN Power Amplifier
QPA1003DPCB4B01	Evaluation Board

Electrical Specifications

Test conditions unless otherwise noted: 25 °C, $V_D = +28\text{ V}$, $I_{DQ} = 650\text{ mA CW}$

Parameter	Min	Typ	Max	Units
Operational Frequency Range	1	–	8	GHz
Output Power @ $P_{IN} = 15\text{ dBm}$	Frequency = 1 GHz	39.4	–	dBm
	Frequency = 4 GHz	40.6	–	
	Frequency = 8 GHz	40	–	
Power Added Efficiency @ $P_{IN} = 15\text{ dBm}$	Frequency = 1 GHz	46.8	–	%
	Frequency = 4 GHz	34.4	–	
	Frequency = 8 GHz	30.4	–	
Small Signal Gain	Frequency = 1 GHz	31.5	–	dB
	Frequency = 4 GHz	32.6	–	
	Frequency = 8 GHz	31	–	
Input Return Loss	Frequency = 1 GHz	13.2	–	dB
	Frequency = 4 GHz	14.7	–	
	Frequency = 8 GHz	14.4	–	
Output Return Loss	Frequency = 1 GHz	16.7	–	dB
	Frequency = 4 GHz	11	–	
	Frequency = 8 GHz	21	–	
Small Signal Gain Temperature Coefficient	–	–0.04	–	dB/°C
Output Power Temperature Coefficient	–	–0.012	–	dBm/°C

Recommended Operating Conditions

Parameter	Value / Range
Drain Voltage (V_D)	+28 V
Drain Current (I_{DQ})	650 mA
Gate Voltage Range (V_G)	–2.8 to –2.0 V
Temperature (T_{BASE})	–40 to 85 °C

Electrical specifications are measured at specified test conditions. Specifications are not guaranteed over all recommended operating conditions.

Performance Plots – Large Signal (CW)

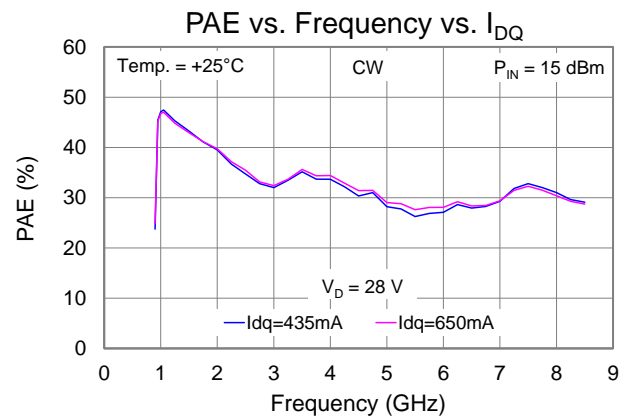
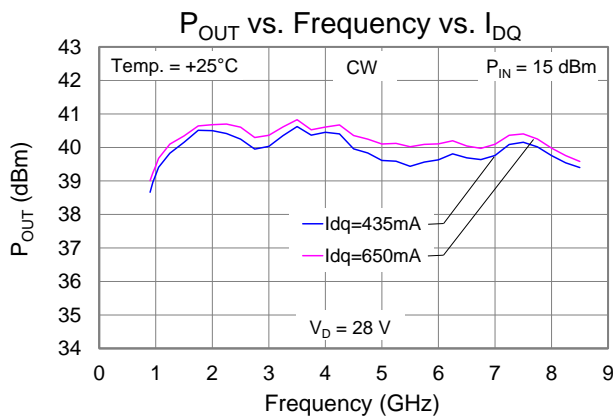
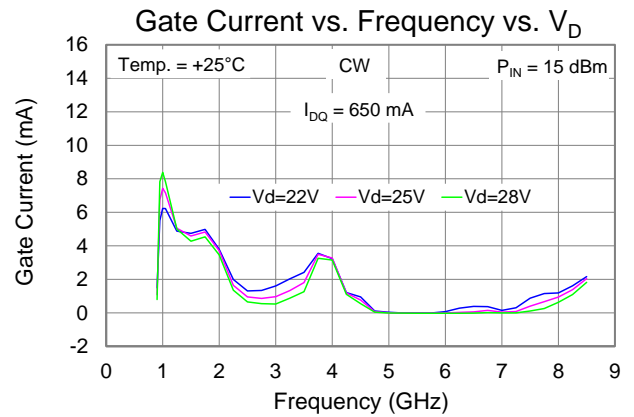
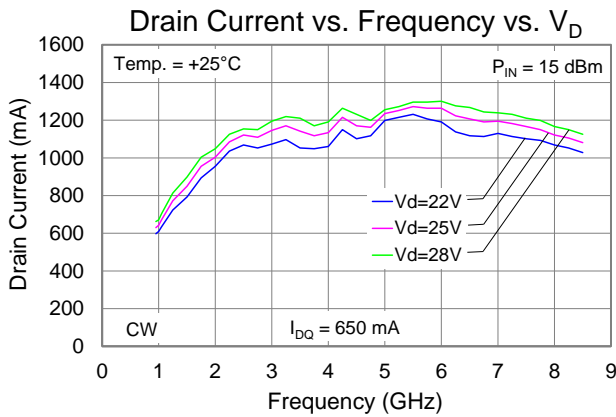
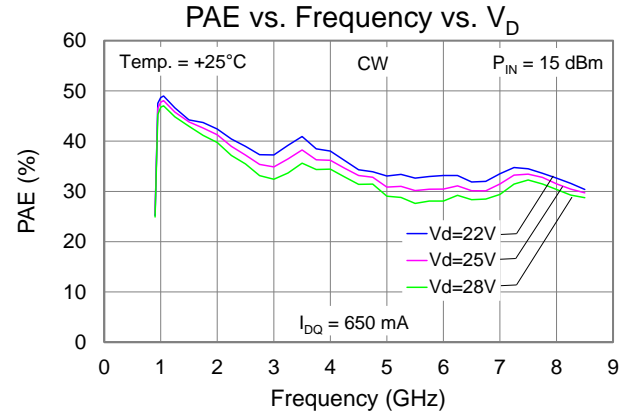
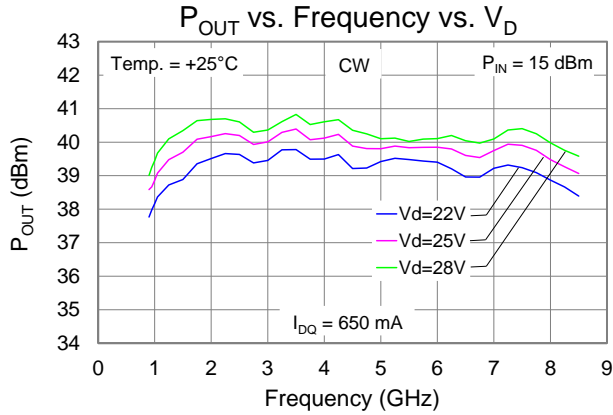

Performance Plots – Large Signal (CW)

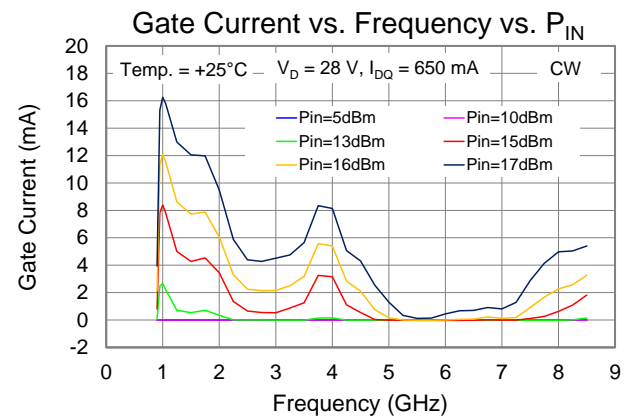
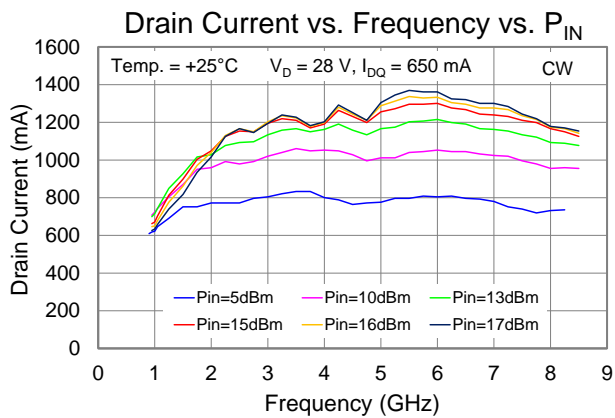
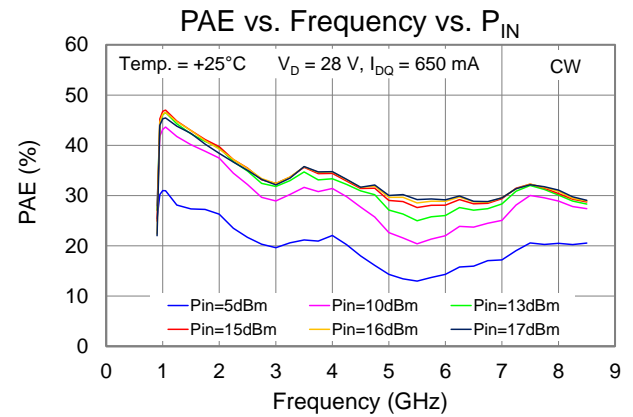
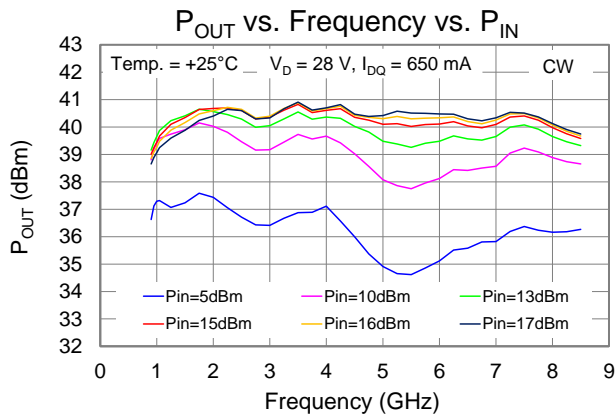
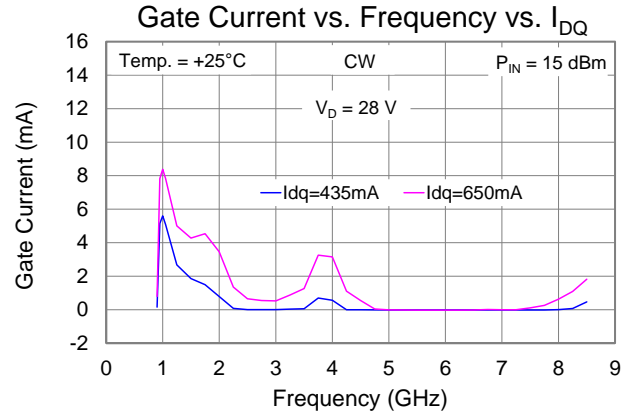
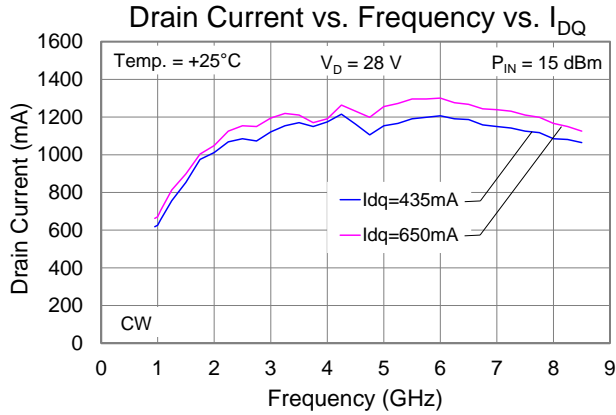

Performance Plots – Large Signal (CW)

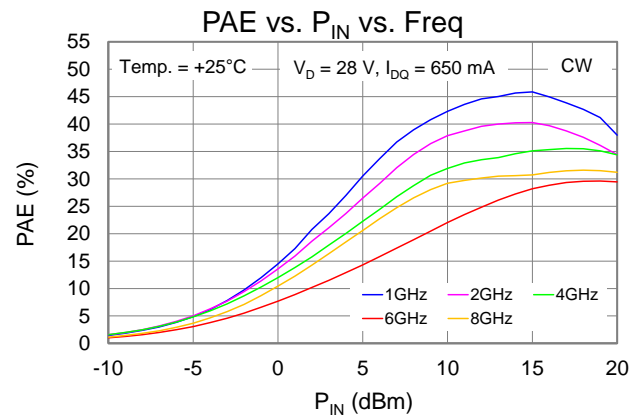
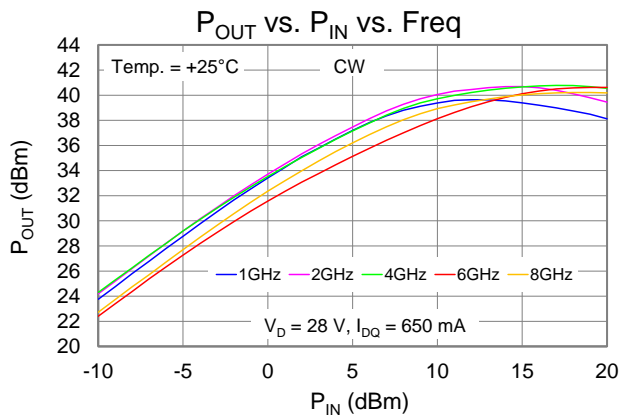
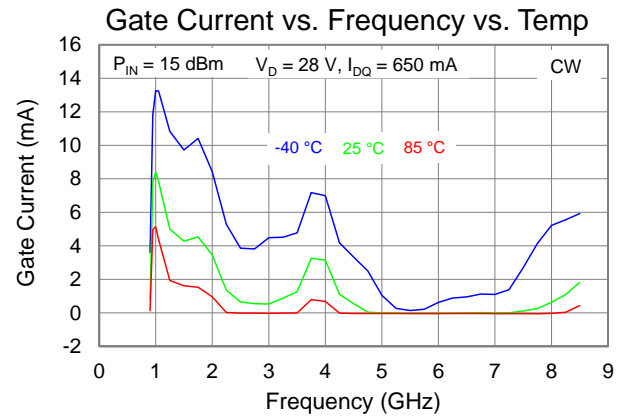
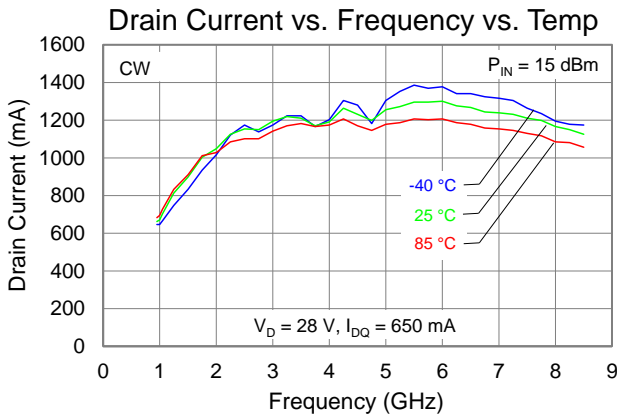
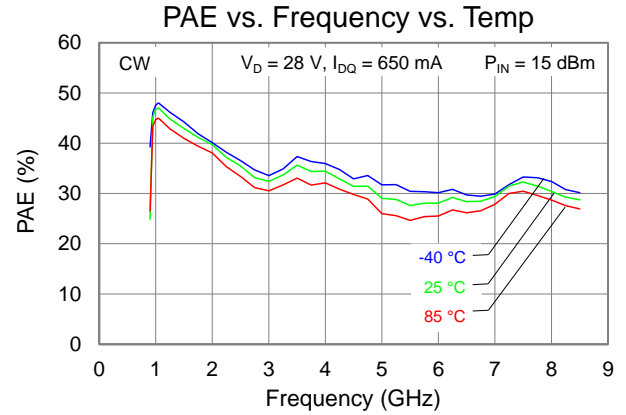
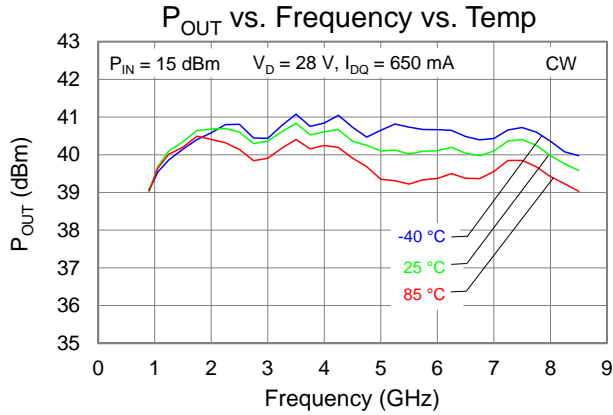

Performance Plots – Large Signal (CW)

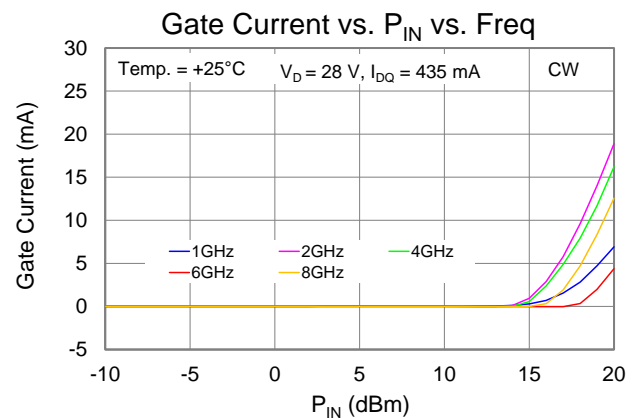
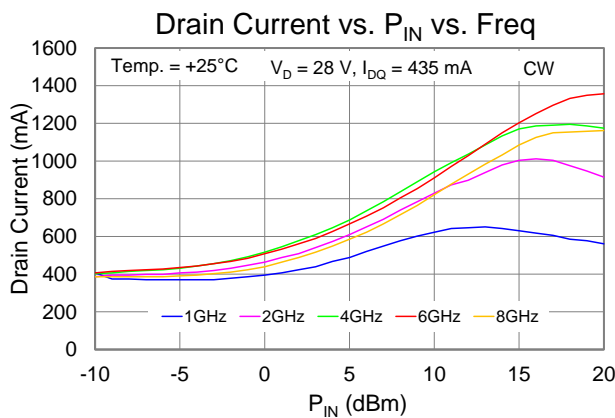
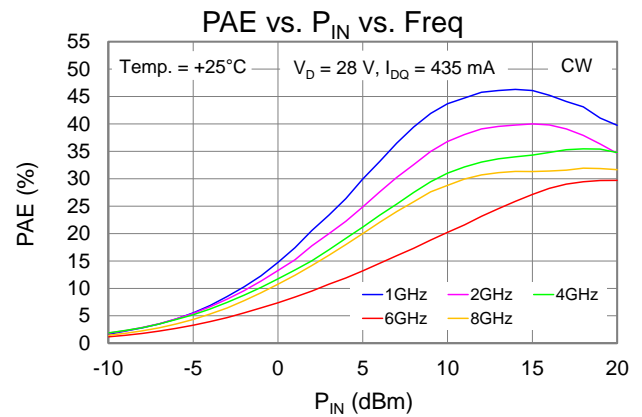
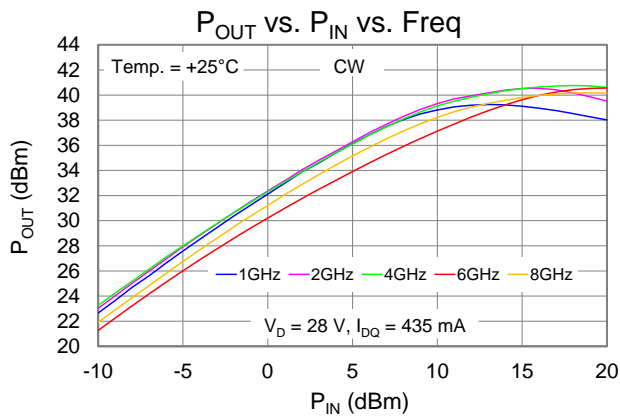
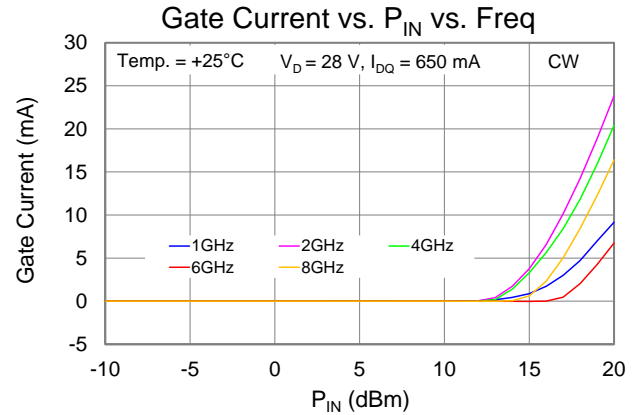
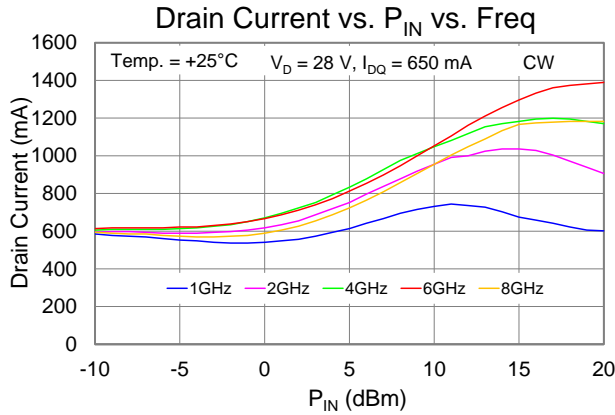

Performance Plots – Large Signal (CW)

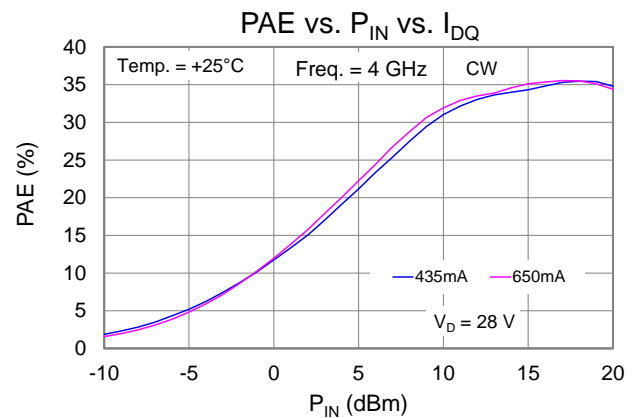
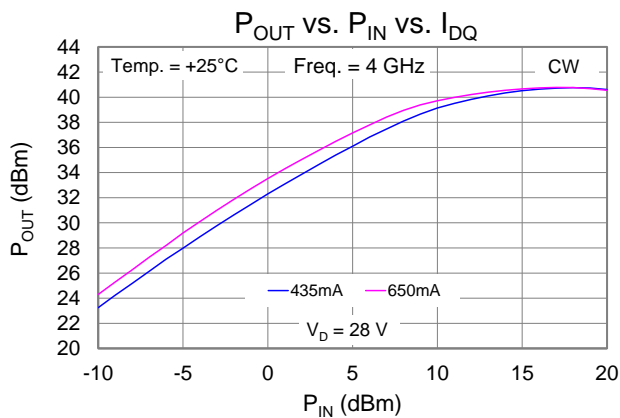
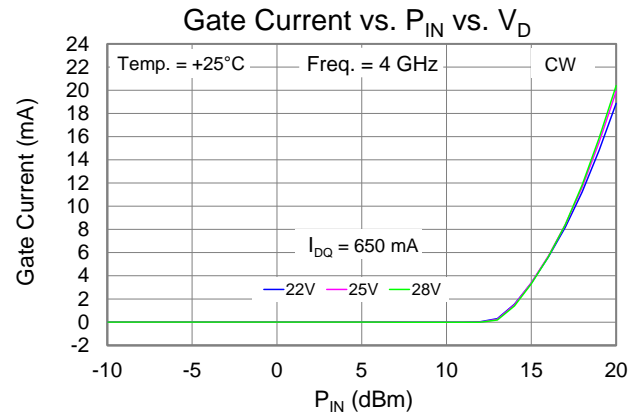
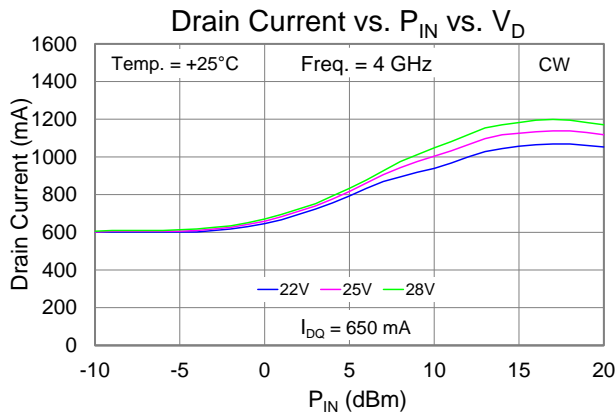
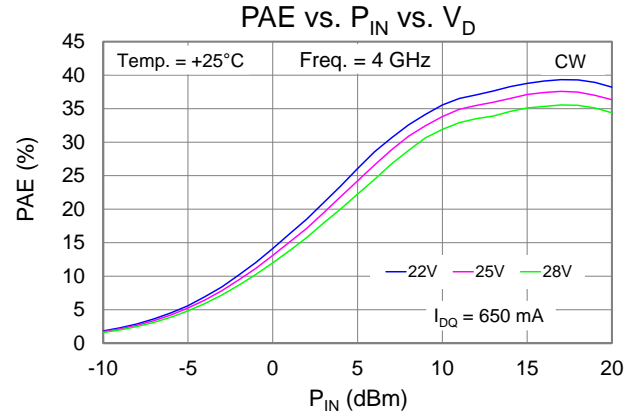
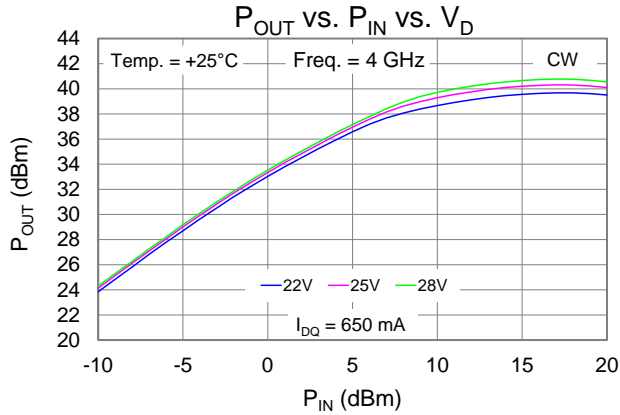

Performance Plots – Large Signal (CW)

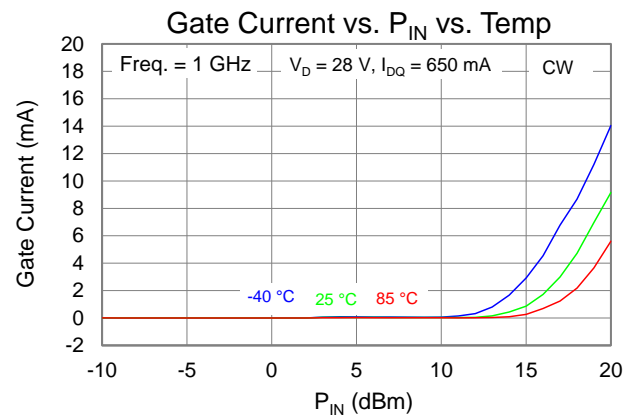
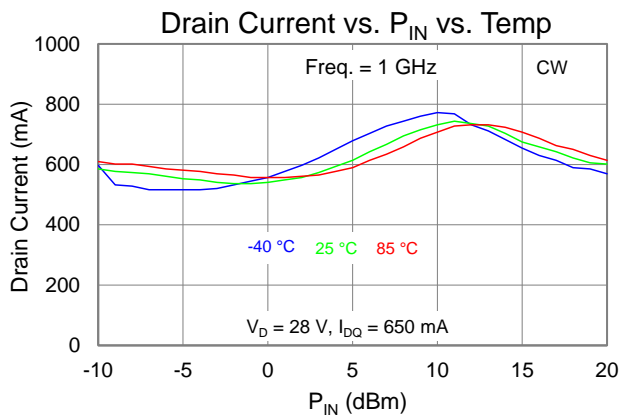
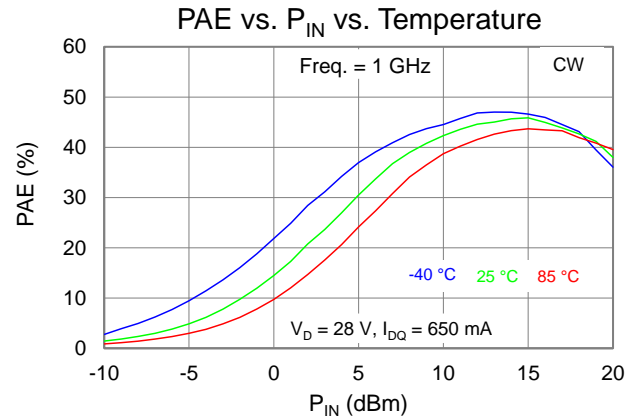
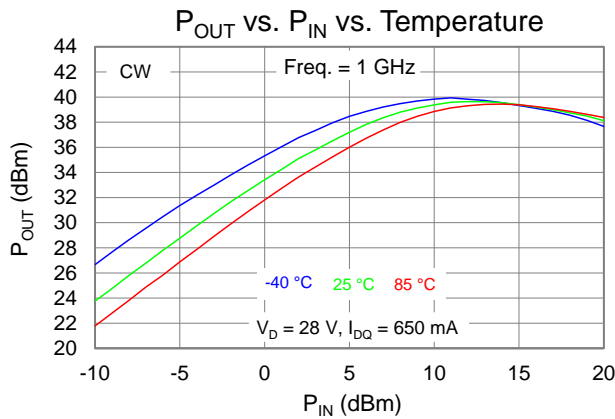
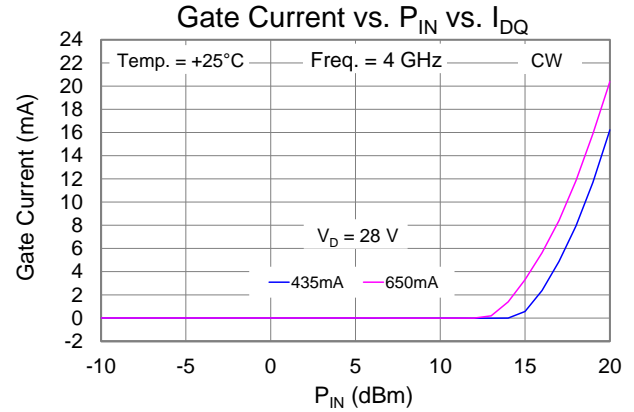
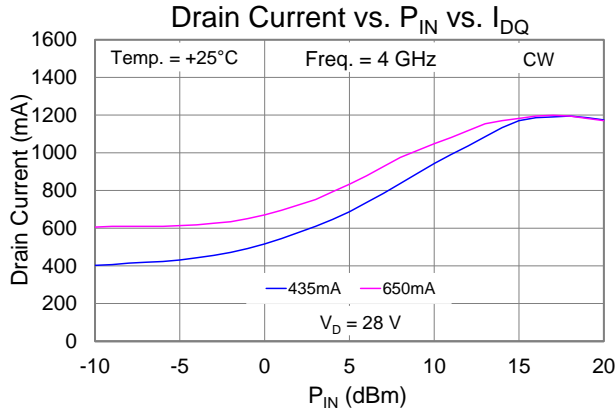

Performance Plots – Large Signal (CW)

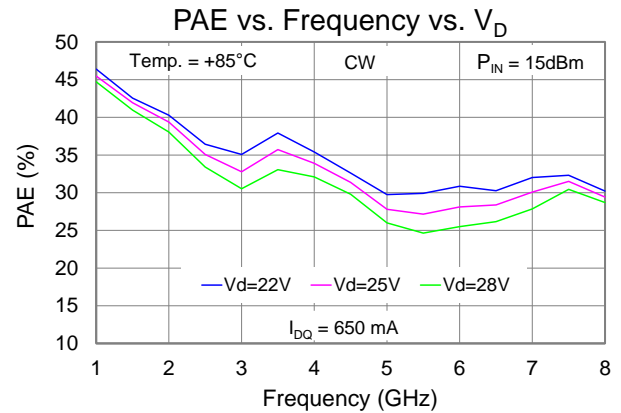
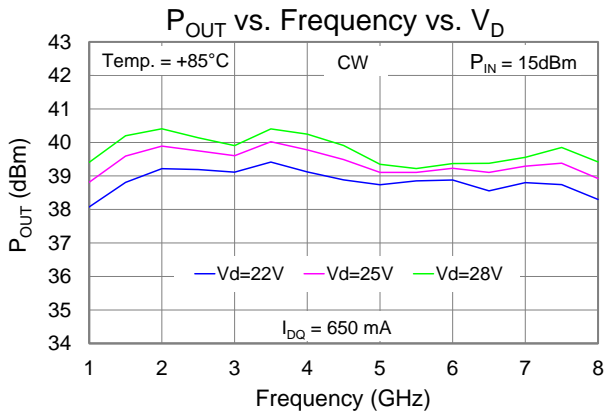
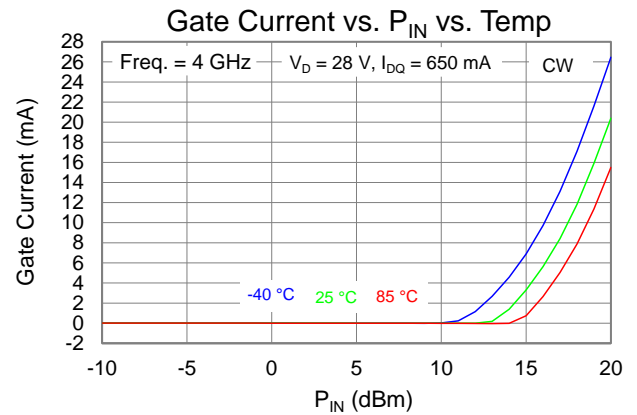
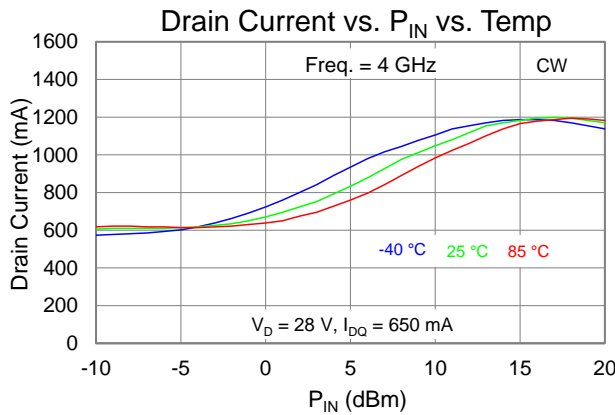
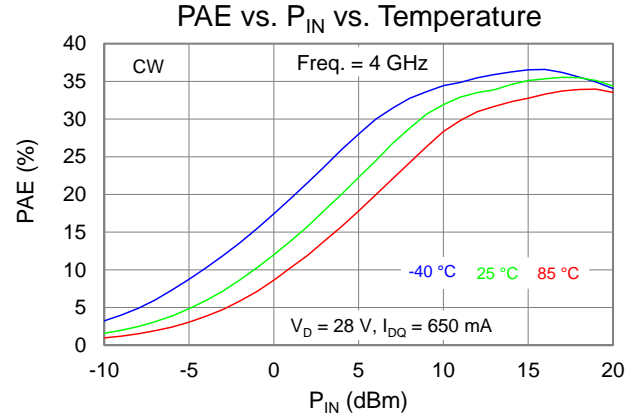
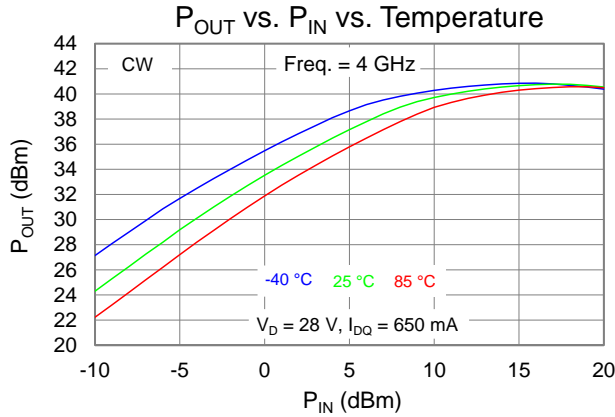

Performance Plots – Linearity

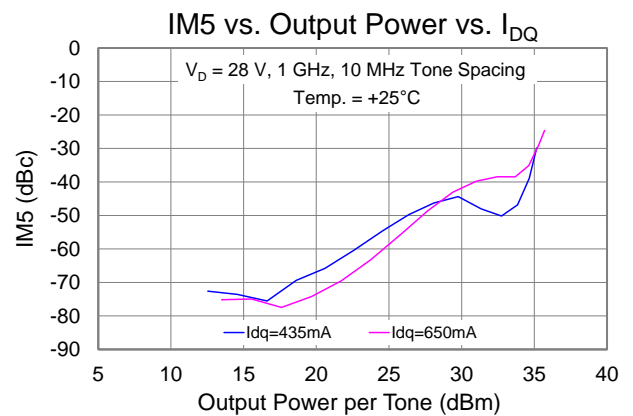
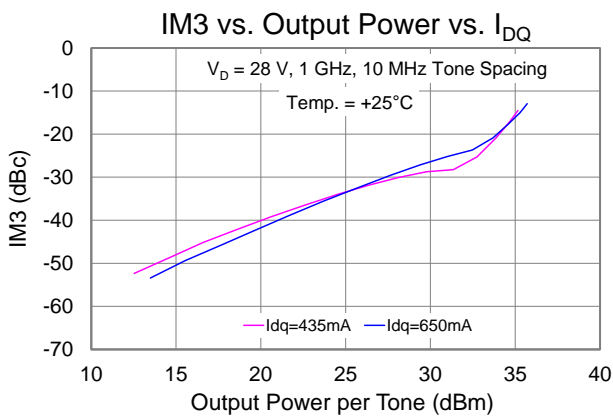
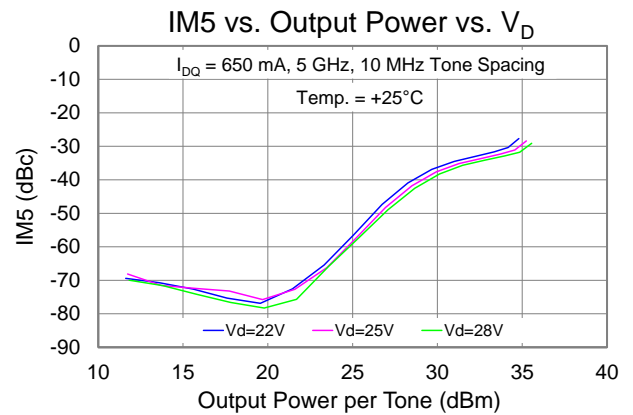
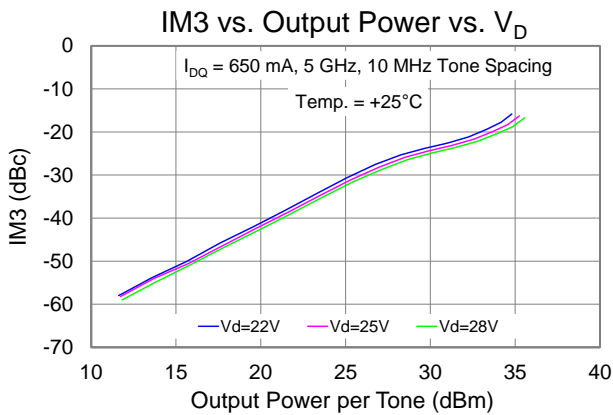
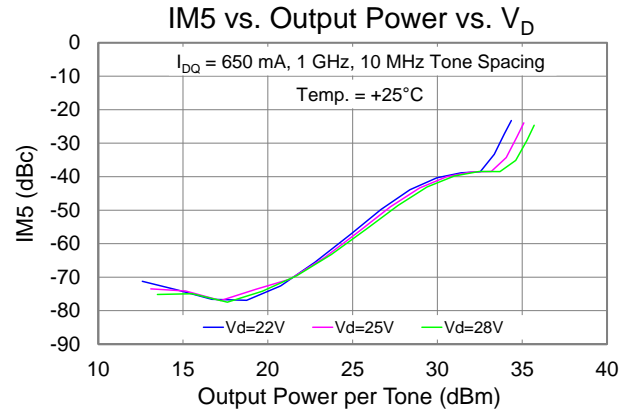
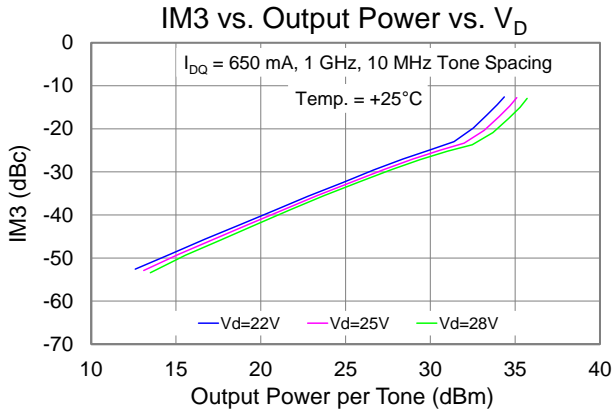

Performance Plots – Linearity

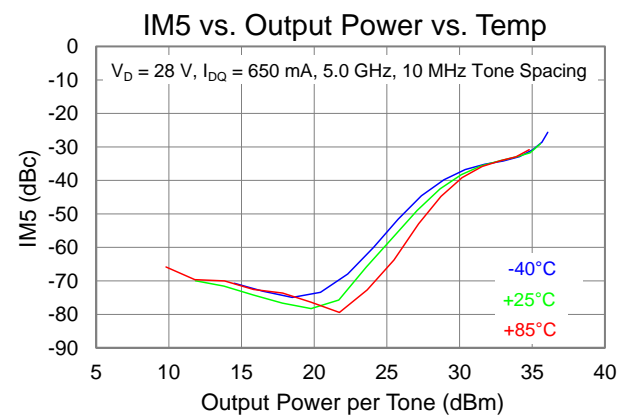
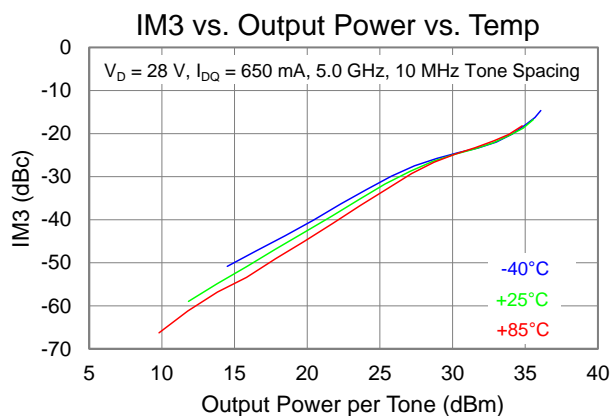
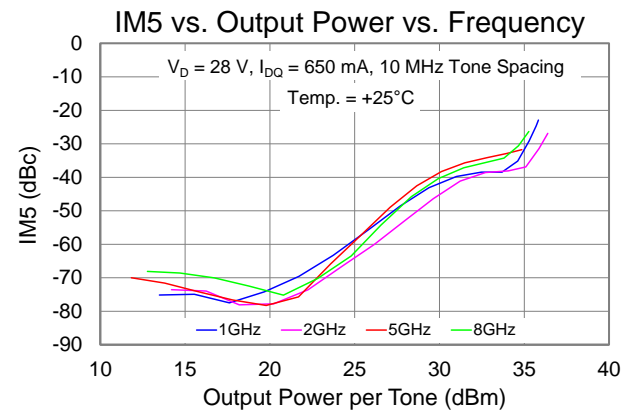
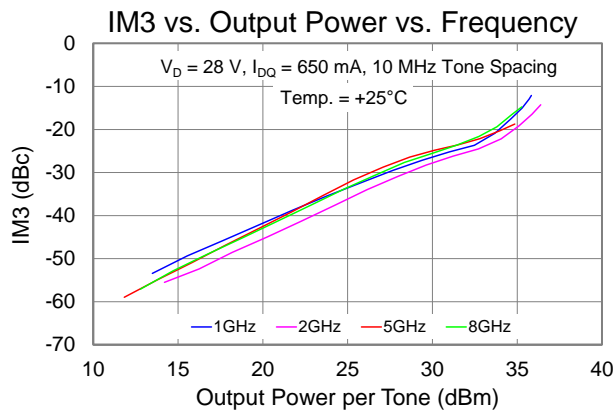
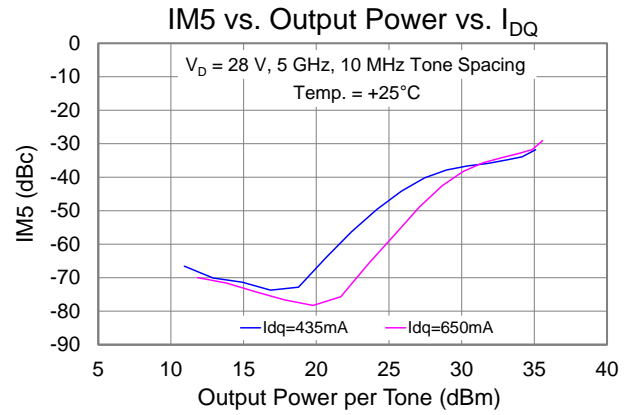
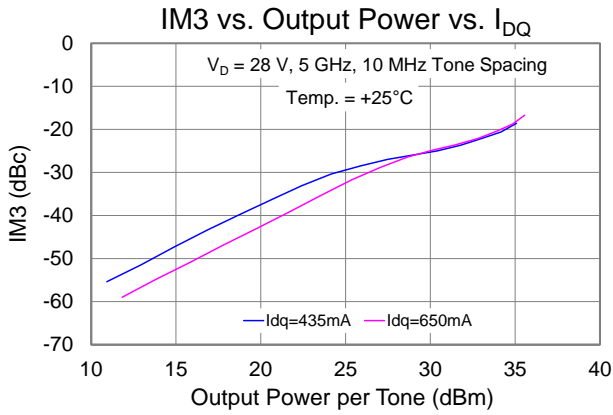

Performance Plots – Linearity

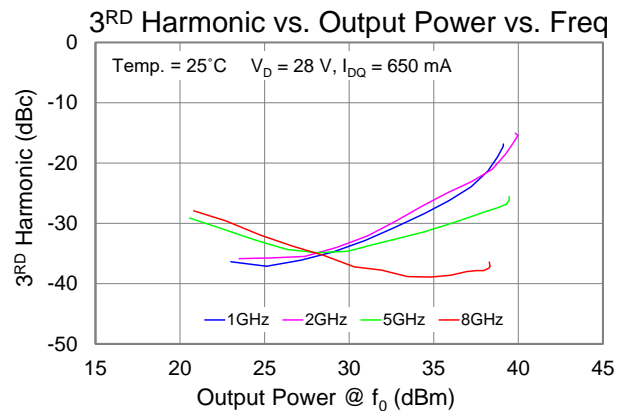
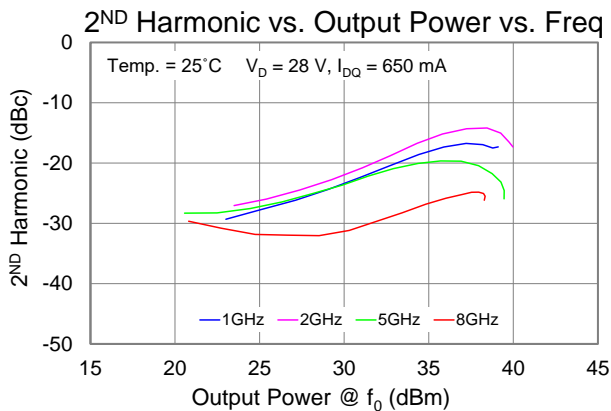
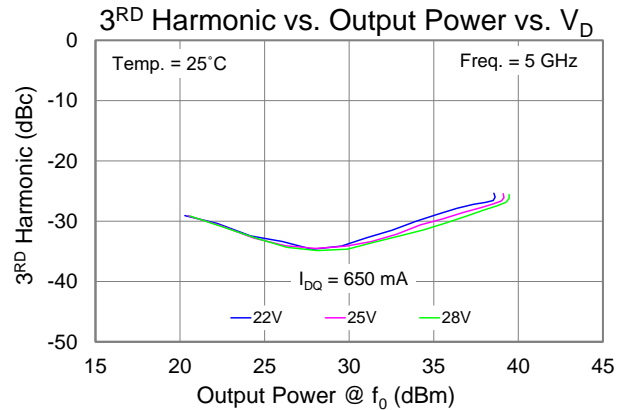
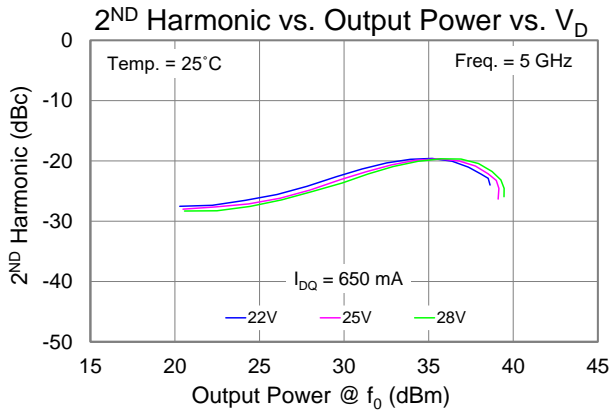
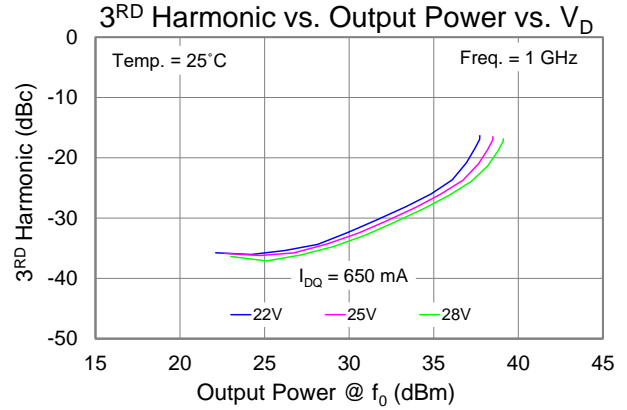
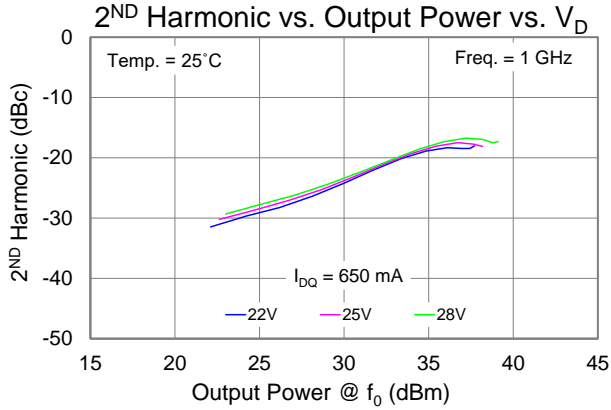

Performance Plots – Linearity

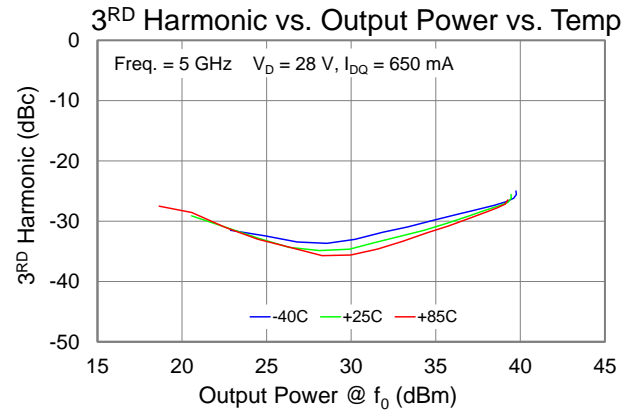
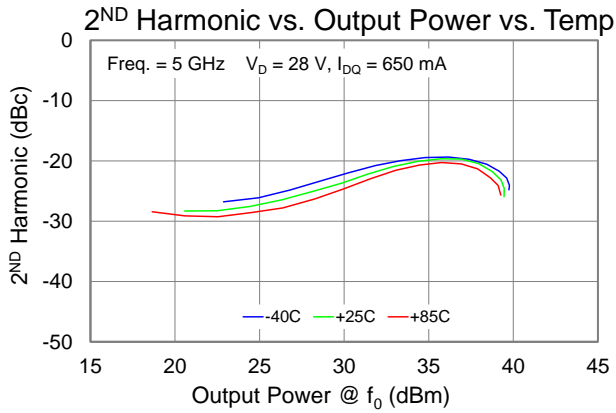
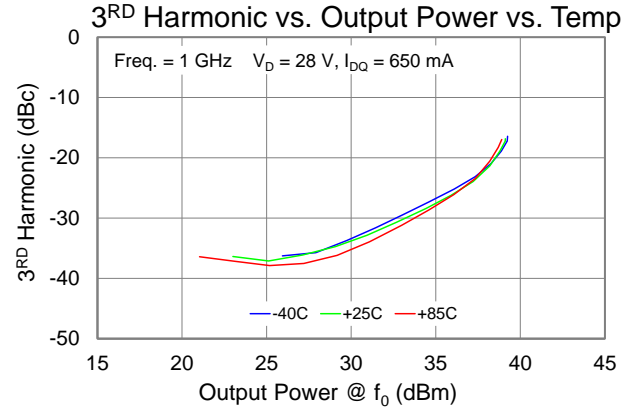
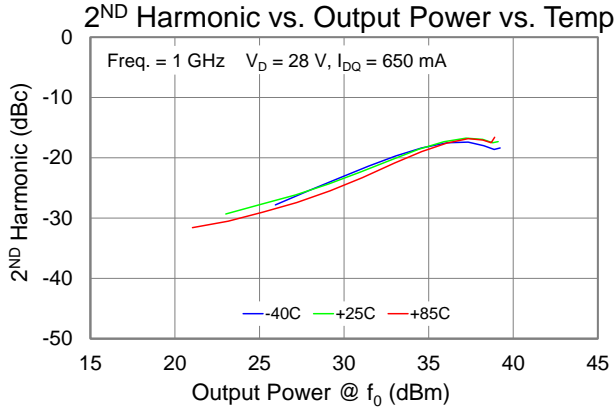

Performance Plots – Small Signal

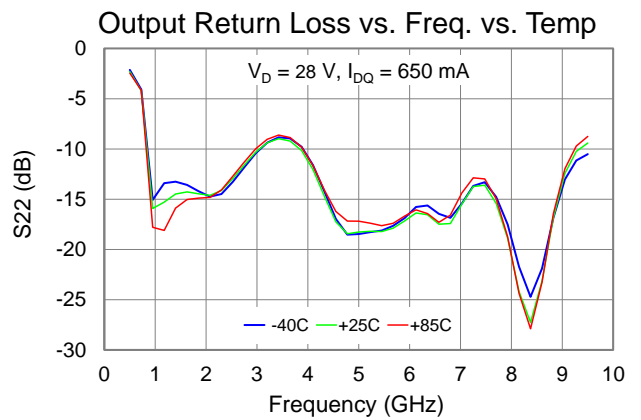
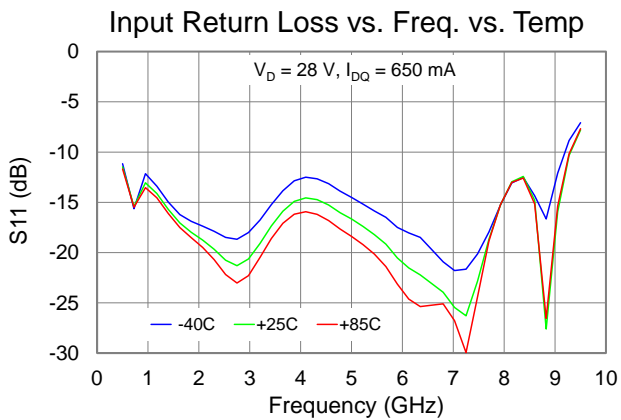
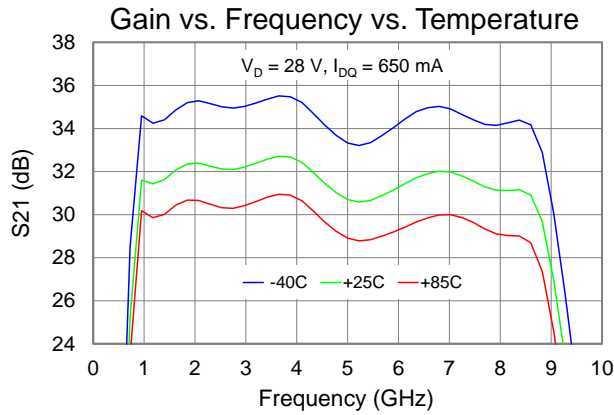
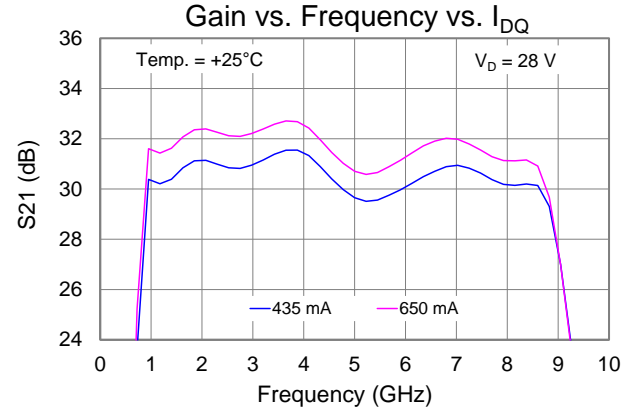
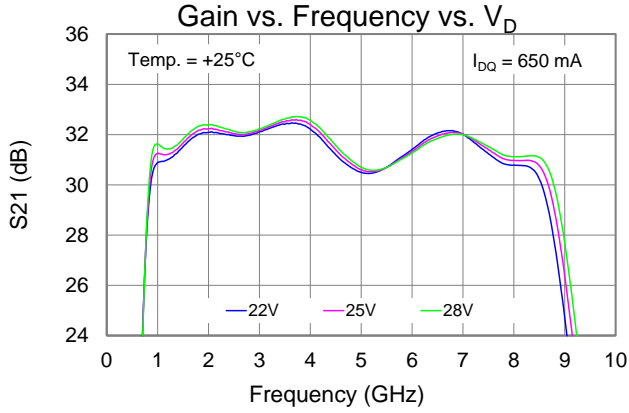

Thermal and Reliability Information

Parameter	Test Conditions	Value	Units
Thermal Resistance (θ_{JC}) ⁽¹⁾	$T_{BASE} = 85^{\circ}\text{C}$, $V_D = +28\text{ V (CW)}$, $I_{DQ} = 650\text{ mA}$, $P_{DISS} = 18.2\text{ W}$	3.53	$^{\circ}\text{C/W}$
Channel Temperature (T_{CH}) (Quiescent)		149.2	$^{\circ}\text{C}$
Thermal Resistance (θ_{JC}) ⁽¹⁾	$T_{BASE} = 85^{\circ}\text{C}$, $V_D = +25\text{ V (CW)}$, Freq = 5.5 GHz $P_{IN} = 15\text{ dBm}$, $I_{DQ} = 650\text{ mA}$, $I_{D_Drive} = 1.2\text{ A}$, $P_{OUT} = 39\text{ dBm}$, $P_{DISS} = 22\text{ W}$	3.92	$^{\circ}\text{C/W}$
Channel Temperature (T_{CH}) (Under RF drive)		171.2	$^{\circ}\text{C}$
Thermal Resistance (θ_{JC}) ⁽¹⁾	$T_{BASE} = 85^{\circ}\text{C}$, $V_D = +28\text{ V (CW)}$, Freq = 5.5 GHz $P_{IN} = 15\text{ dBm}$, $I_{DQ} = 650\text{ mA}$, $I_{D_Drive} = 1.2\text{ A}$, $P_{OUT} = 39\text{ dBm}$, $P_{DISS} = 25.5\text{ W}$	4.01	$^{\circ}\text{C/W}$
Channel Temperature (T_{CH}) (Under RF drive)		187.2	$^{\circ}\text{C}$

Notes:

1. Thermal resistance measured to back of carrier plate. MMIC mounted to 20 mil CuMo carrier using eutectic die attach
2. IR scan equivalent. Refer to the following document: [GaN Device Channel Temperature, Thermal Resistance, and Reliability Estimates](#)

Power Dissipation and Maximum Gate Current

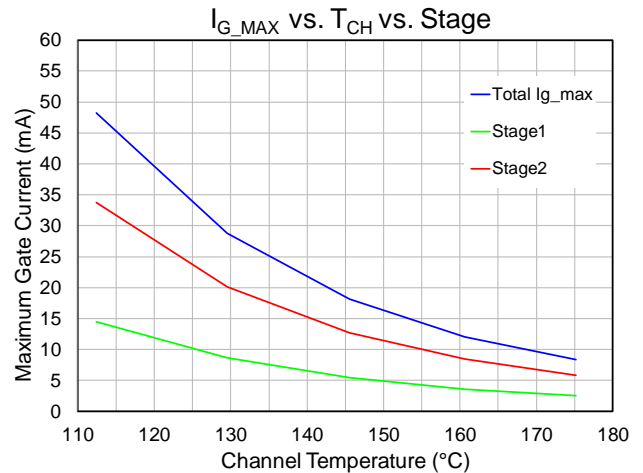
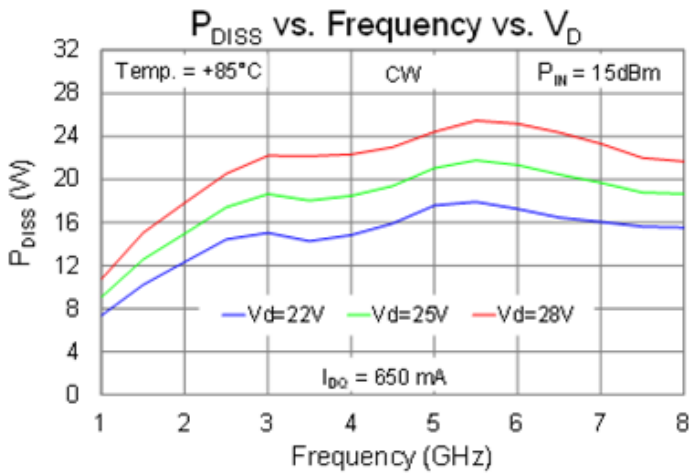

Applications Information and Pad Layout

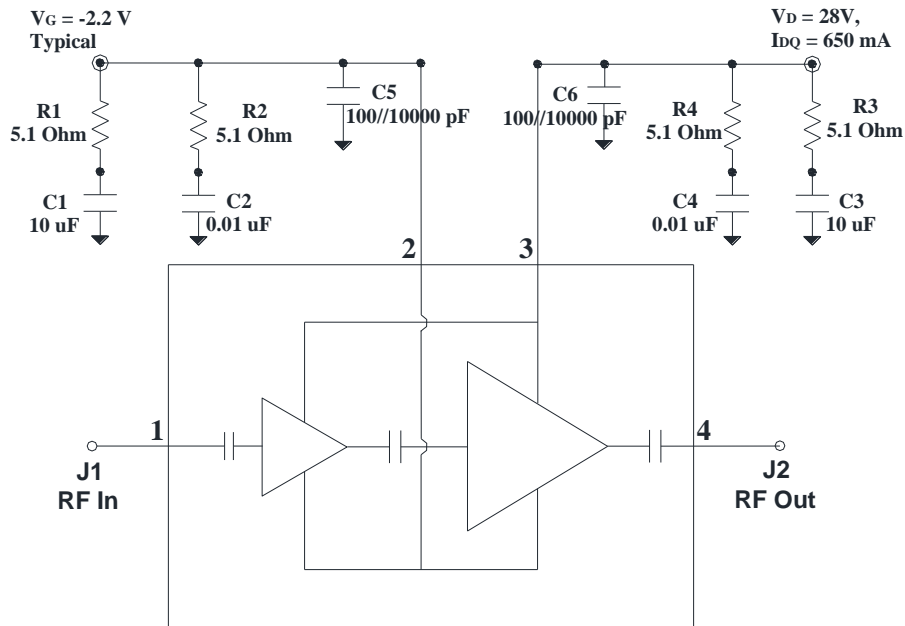

Bias Up Procedure

1. Set I_D limit to 1.3 A, I_G limit to 6 mA
2. Apply -5 V to V_G
3. Apply $+28\text{ V}$ to V_D ; ensure I_{DQ} is approx. 0 mA
4. Adjust V_G until $I_{DQ} = 650\text{ mA}$ ($V_G \sim -2.2\text{ V Typ.}$).
5. Turn on RF supply

Bias Down Procedure

1. Turn off RF supply
2. Reduce V_G to -5 V ; ensure I_{DQ} is approx. 0 mA
3. Set V_D to 0 V
4. Turn off V_D supply
5. Turn off V_G supply

Evaluation Board (EVB) Layout Assembly

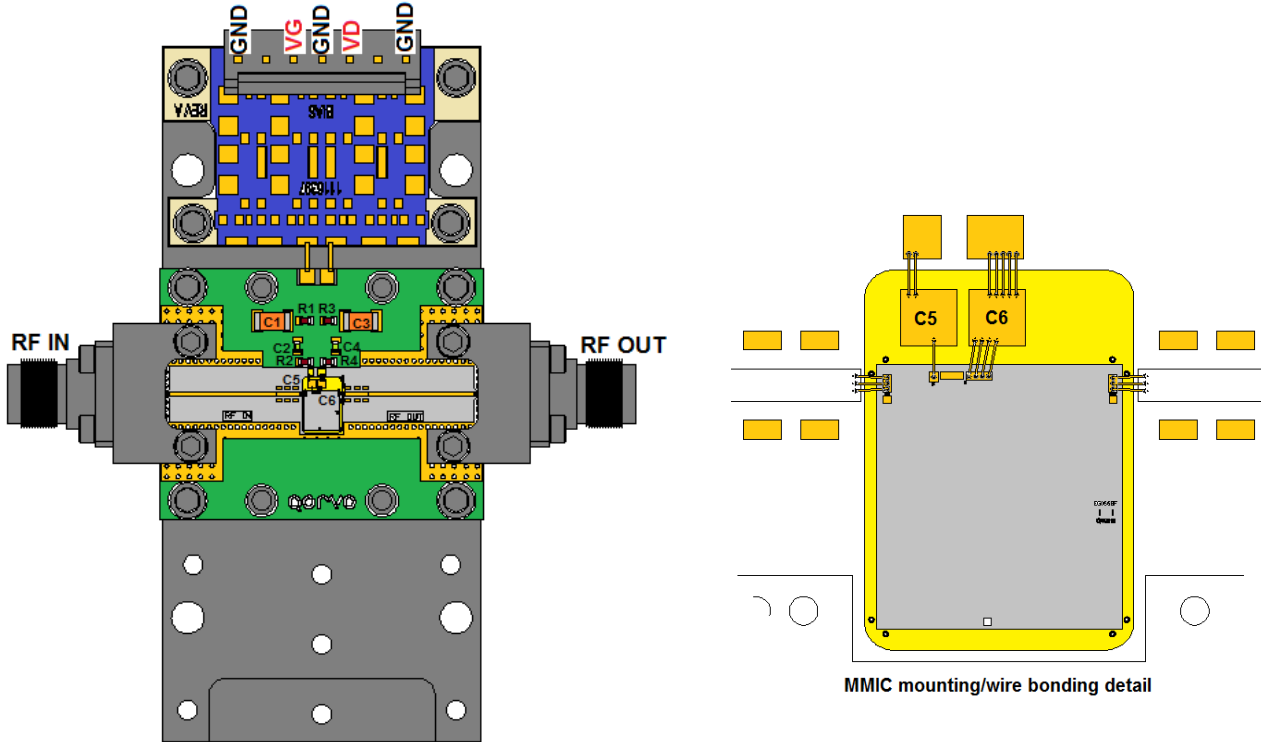

Bill of Materials

Reference Des.	Value	Description	Manuf.	Part Number
C1, C3	10 μ F	Cap, 1205, 50 V, 20 %, X7R	Various	–
C2, C4	0.01 μ F	Cap, 0402, 50 V, 10 %, X5R	Various	–
C5, C6	100pF/10000 pF	Cap, 30 x 30, 50V, Single Layer	Various	–
R1, R2, R3, R4	5.1 Ohm	Res, 0402, 50 V, 5 %	Various	–

Mechanical Information

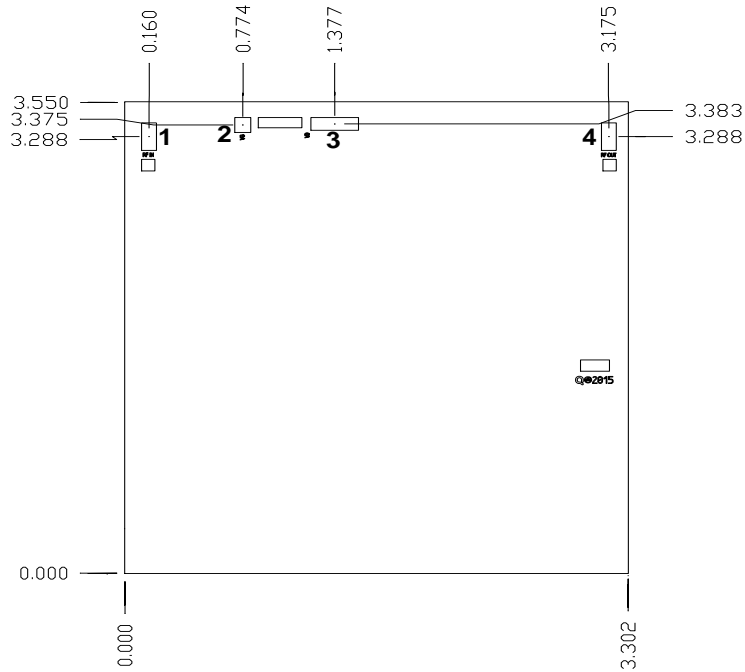

Units: millimeters
 Thickness: 0.10
 Die x,y size tolerance: ± 0.050
 Ground is backside of die

Bond Pad Description

Pad No.	Symbol	Pad Size (mm)	Description
1	RF In	0.097 x 0.207	RF Input; matched to 50 Ω , DC blocked
2	VG	0.105 x 0.112	Gate voltage, bias network is required; see Application Circuit on page 16 as an example.
3	VD	0.312 x 0.096	Drain voltage, bias network is required; see Application Circuit on page 16 as an example.
4	RF Out	0.097 x 0.207	RF Output; matched to 50 Ω , DC blocked

Assembly Notes

Component placement and adhesive attachment assembly notes:

- Vacuum pencils and/or vacuum collets are the preferred method of pick up.
- Air bridges must be avoided during placement.
- The force impact is critical during auto placement.

Reflow process assembly notes:

- Use AuSn (80/20) solder and limit exposure to temperatures above 300 °C to 3–4 minutes, maximum.
- An alloy station or conveyor furnace with reducing atmosphere should be used.
- Do not use any kind of flux.
- Coefficient of thermal expansion matching is critical for long-term reliability.
- Devices must be stored in a dry nitrogen atmosphere.

Interconnect process assembly notes:

- Thermosonic ball bonding is the preferred interconnect technique.
- Force, time, and ultrasonic are critical parameters.
- Aluminum wire should not be used.
- Devices with small pad sizes should be bonded with 0.0007-inch wire.

Absolute Maximum Ratings

Parameter	Value / Range
Drain Voltage (V_D)	+29.5 V
Gate Voltage Range (V_G)	-8 to 0 V
Drain Current	1300 mA
Forward Gate Current (I_G)	See I_{G_MAX} plot
Power Dissipation (P_{DISS}), 85 °C, CW	30 W
Input Power, CW, 50 Ω , (P_{IN}), $V_D = +28$ V, $I_{DQ} = 650$ mA, 85 °C,	18 dBm
Input Power, CW, VSWR 3:1, (P_{IN}) $V_D = +28$ V, $I_{DQ} = 650$ mA, 85 °C	18 dBm
Mounting Temperature (30 Seconds)	320 °C
Storage Temperature	-55 to 150 °C

Operation of this device outside the parameter ranges given above may cause permanent damage. These are stress ratings only, and functional operation of the device at these conditions is not implied.

Handling Precautions

Parameter	Rating	Standard
ESD – Human Body Model (HBM)	TBD	ESDA / JEDEC JS-001-2012



Caution!
ESD-Sensitive Device

Solderability

Use only AuSn (80/20) solder, and limit exposure to temperatures above 300 °C to 3–4 minutes, maximum.

RoHS Compliance

This product is compliant with the 2011/65/EU RoHS directive (Restrictions on the Use of Certain Hazardous Substances in Electrical and Electronic Equipment), as amended by Directive 2015/863/EU. This product also has the following attributes:

- Lead Free
- Halogen Free (Chlorine, Bromine)
- Antimony Free
- TBBP-A (C₁₅H₁₂Br₄O₂) Free
- PFOS Free
- SVHC Free

Contact Information

For the latest specifications, additional product information, worldwide sales and distribution locations:

Web: www.qorvo.com

Tel: 1-844-890-8163

E-mail: customer.support@qorvo.com

Important Notice

The information contained herein is believed to be reliable; however, Qorvo makes no warranties regarding the information contained herein and assumes no responsibility or liability whatsoever for the use of the information contained herein. All information contained herein is subject to change without notice. Customers should obtain and verify the latest relevant information before placing orders for Qorvo products. The information contained herein or any use of such information does not grant, explicitly or implicitly, to any party any patent rights, licenses, or any other intellectual property rights, whether with regard to such information itself or anything described by such information. **THIS INFORMATION DOES NOT CONSTITUTE A WARRANTY WITH RESPECT TO THE PRODUCTS DESCRIBED HEREIN, AND QORVO HEREBY DISCLAIMS ANY AND ALL WARRANTIES WITH RESPECT TO SUCH PRODUCTS WHETHER EXPRESS OR IMPLIED BY LAW, COURSE OF DEALING, COURSE OF PERFORMANCE, USAGE OF TRADE OR OTHERWISE, INCLUDING THE IMPLIED WARRANTIES OF MERCHANTABILITY AND FITNESS FOR A PARTICULAR PURPOSE.**

Without limiting the generality of the foregoing, Qorvo products are not warranted or authorized for use as critical components in medical, life-saving, or life-sustaining applications, or other applications where a failure would reasonably be expected to cause severe personal injury or death.

Copyright 2019 © Qorvo, Inc. | Qorvo is a registered trademark of Qorvo, Inc.

X-ON Electronics

Largest Supplier of Electrical and Electronic Components

Click to view similar products for [RF Amplifier](#) category:

Click to view products by [Qorvo](#) manufacturer:

Other Similar products are found below :

[A82-1](#) [BGA622H6820XTSA1](#) [BGA 728L7 E6327](#) [BGB719N7ESDE6327XTMA1](#) [HMC397-SX](#) [HMC405](#) [HMC561-SX](#) [HMC8120-SX](#)
[HMC8121-SX](#) [HMC-ALH382-SX](#) [HMC-ALH476-SX](#) [SE2433T-R](#) [SMA3101-TL-E](#) [SMA39](#) [A66-1](#) [A66-3](#) [A67-1](#) [LX5535LQ](#) [LX5540LL](#)
[MAAM02350](#) [HMC3653LP3BETR](#) [HMC549MS8GETR](#) [HMC-ALH435-SX](#) [SMA101](#) [SMA32](#) [SMA411](#) [SMA531](#) [SST12LP17E-XX8E](#)
[SST12LP19E-QX6E](#) [WPM0510A](#) [HMC5929LS6TR](#) [HMC5879LS7TR](#) [HMC1126](#) [HMC1087F10](#) [HMC1086](#) [HMC1016](#) [SMA1212](#)
[MAX2689EWS+T](#) [MAAMSS0041TR](#) [MAAM37000-A1G](#) [LTC6430AIUF-15#PBF](#) [CHA5115-QDG](#) [SMA70-2](#) [SMA4011](#) [A231](#) [HMC-](#)
[AUH232](#) [LX5511LQ](#) [LX5511LQ-TR](#) [HMC7441-SX](#) [HMC-ALH310](#)