

Product Description

Qorvo’s QPA1011 is a X-band high power MMIC amplifier fabricated on Qorvo’s production 0.15um GaN on SiC process (QGaN15). The QPA1011 operates from 7.9 – 11 GHz and typically provides 25 W saturated output power with power-added efficiency of 40% and large-signal gain of 19.5 dB. This combination of wideband performance provides the flexibility designers are looking for to improve system performance while reducing size and cost.

QPA1011 can also support a variety of operating conditions to best support system requirements. With good thermal properties, it can support a range of bias voltages and will perform well under both CW and pulse operations.

The QPA1011 is matched to 50Ω with integrated DC blocking capacitors on both RF I/O ports simplifying system integration. The wideband performance and operational flexibility allow it support satellite communication and data links, as well as, military and commercial radar systems.

Lead-free and RoHS compliant.

Functional Block Diagram

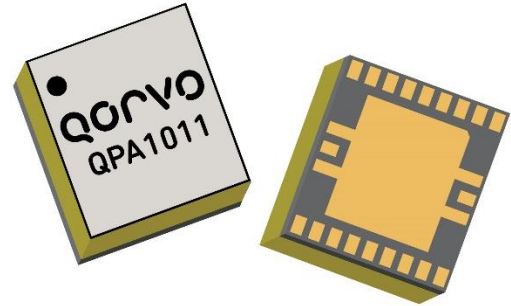
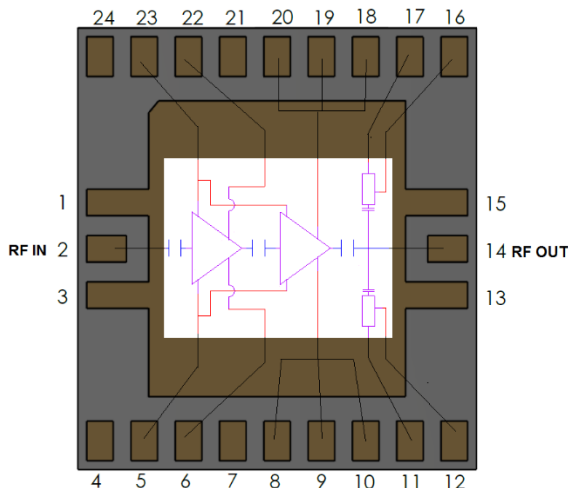

24-Lead 4.5 x 5.0 x 1.72 mm Air Cavity Laminate Package

Product Features

- Frequency Range: 7.9 – 11 GHz
- P_{OUT} ($P_{IN} = 25$ dBm): 44.5 dBm
- PAE ($P_{IN} = 25$ dBm): 40 %
- Power Gain ($P_{IN} = 25$ dBm): 19.5 dB
- IM3 ($(P_{OUT}/Tone = 38$ dBm): -20 dBc
- Small Signal Gain: 28 dB
- Integrated Power Detector
- Bias: $V_D = 24$ V, $I_{DQ} = 1200$ mA, $V_G = -1.9$ V Typical
- Pulsed V_D : PW = 100 μ S, DC = 10%
- Package Dimensions: 4.5 x 5.0 x 1.72 mm

Performance is typical across frequency. Please reference electrical specification table and data plots for more details.

Applications

- Satellite Communications
- Data Links
- Military and Commercial Radar

Ordering Information

Part No.	Description
QPA1011	7.9 – 11 GHz 25W GaN PA
QPA1011SR	100 Piece 7" Reel
QPA1011TR7	250 Piece 7" Reel
QPA1011PCB4B01	Evaluation Board

Absolute Maximum Ratings

Parameter	Value / Range
Drain Voltage (V_D)	29.5 V
Gate Voltage Range (V_G)	-8 to 0V
Drain Current (I_{D1}/I_{D2})	672 mA / 2880 mA
Gate Current (I_G)	See chart, pg. 21
Power Dissipation (P_{DISS}), 85°C, CW	70 W
Input Power (P_{IN}), CW, 50Ω, $V_D=28$ V, $I_{DQ}=1200$ mA, 85 °C	30 dBm
Input Power (P_{IN}), CW, VSWR 3:1, $V_D=28$ V, $I_{DQ}=1200$ mA 85 °C	30 dBm
Mounting Temperature (30 seconds)	260 °C
Storage Temperature	-55 to 150 °C

Operation of this device outside the parameter ranges given above may cause permanent damage. These are stress ratings only, and functional operation of the device at these conditions is not implied.

Recommended Operating Conditions

Parameter	Value / Range
Drain Voltage (V_D)	24 – 28 V
Drain Current (I_{DQ})	1200 mA
Gate Voltage Range (V_G)	-2.9 to -1.5 V
Temperature (T_{BASE})	-40 to +85 °C

Electrical specifications are measured at specified test conditions. Specifications are not guaranteed over all recommended operating conditions.

Electrical Specifications

Parameter		Min	Typ	Max	Units
Operational Frequency Range		7.9		11	GHz
Output Power ($P_{IN} = 25$ dBm)	7.9 GHz	44.2	45.5		dBm
	9.5 GHz	45	46.2		
	11.0 GHz	43.9	45		
Power Added Efficiency ($P_{IN} = 25$ dBm)	7.9 GHz	36	40		%
	9.5 GHz	35	40		
	11.0 GHz	35	40		
3 rd Order Intermodulation Level ($P_{OUT}/Tone= 38$ dBm)			-20		dBc
Small Signal Gain, S21			28		dB
Input Return Loss, IRL			15		dB
Output Return Loss, ORL			10		dB
Output Power Temperature Coefficient ($P_{IN} = 25$ dBm, $T_{BASE} = 25-85$ °C)			-0.006		dBm/°C
S21 Temperature Coefficient ($T_{BASE} = 25-85$ °C)			-0.053		dB/°C
Gate Leakage ($V_D = 10$ V, $V_G = -4$ V)		-13.2		0.1	mA

Notes:

1. Test conditions, unless otherwise noted: Pulsed V_D , $V_D = 24$ V, $I_{DQ} = 1200$ mA, $PW = 100$ μS, $DC = 10\%$, $V_G = -1.9$ V ± typical, $T_{BASE} = 25$ °C, $Z_0 = 50$ Ω
2. T_{BASE} is back side of package

Performance Plots – Large Signal (Pulsed)

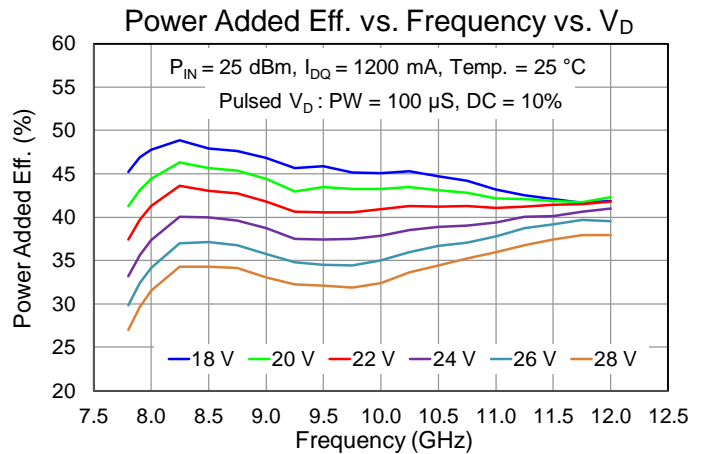
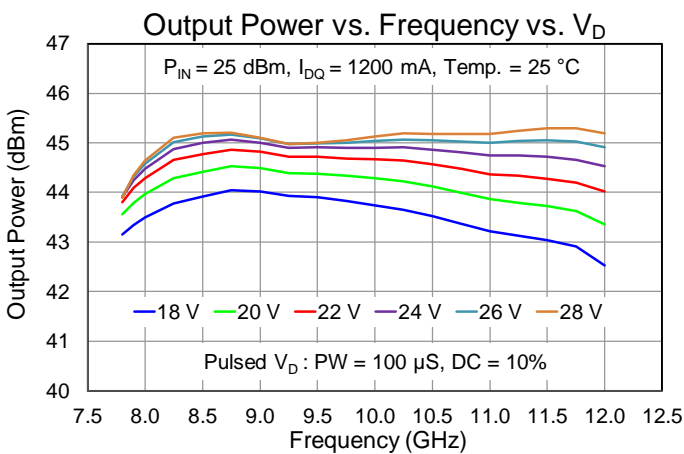
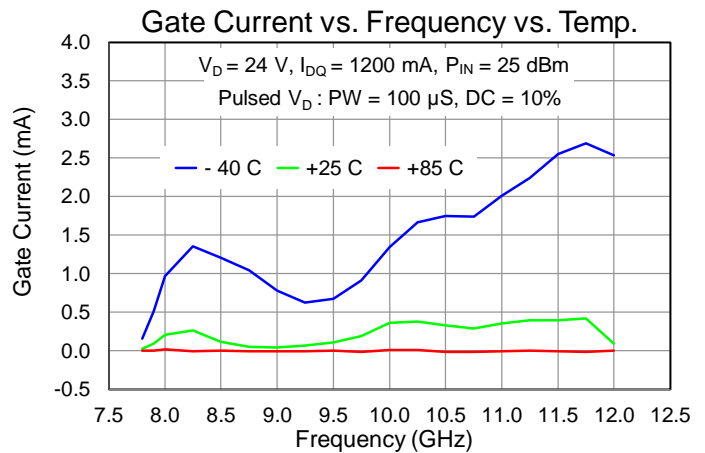
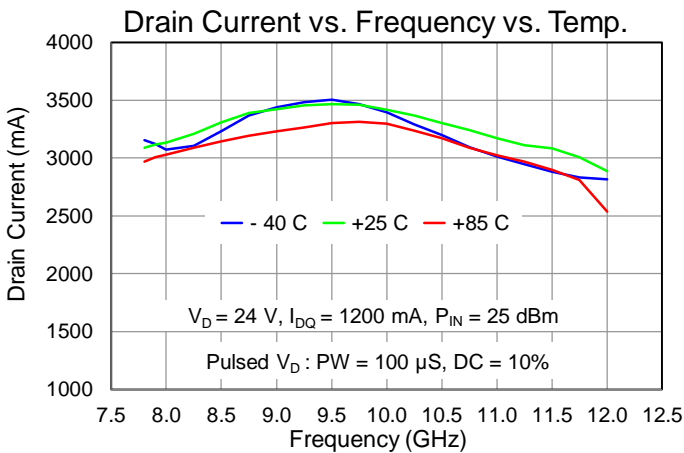
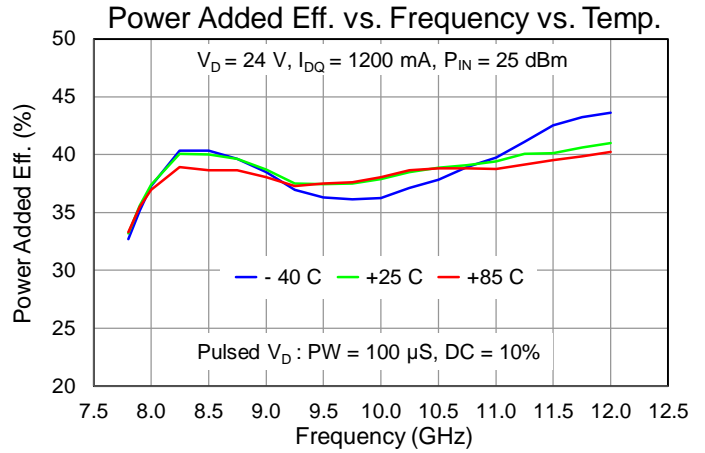
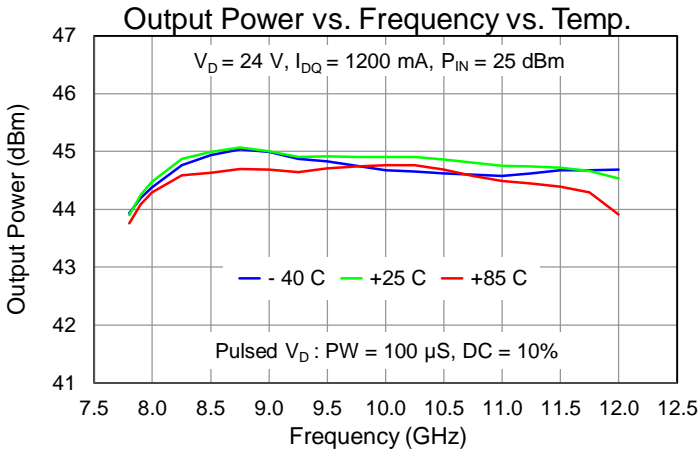

Performance Plots – Large Signal (Pulsed)

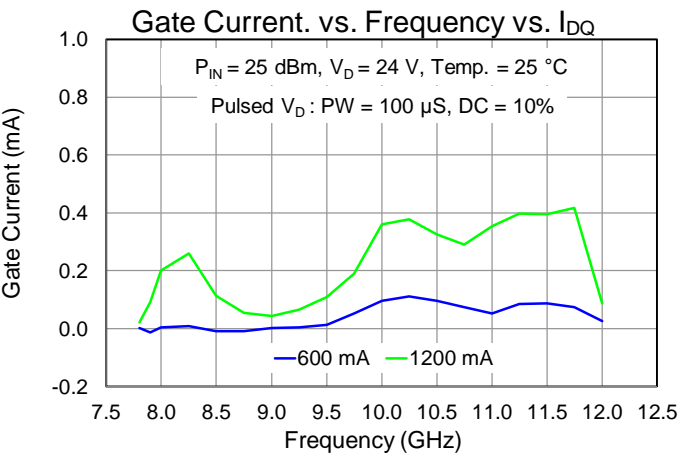
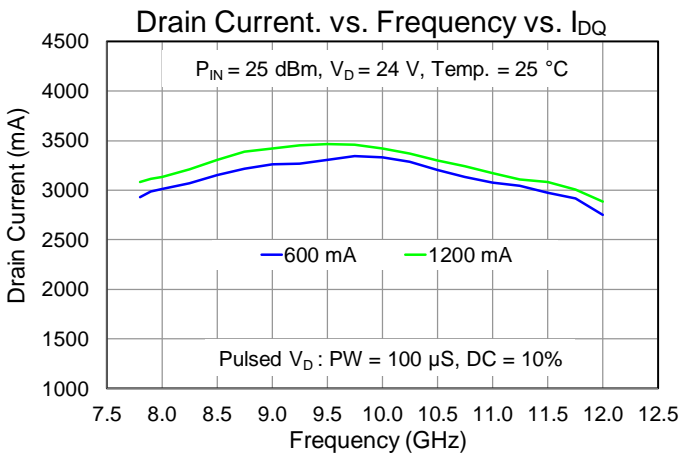
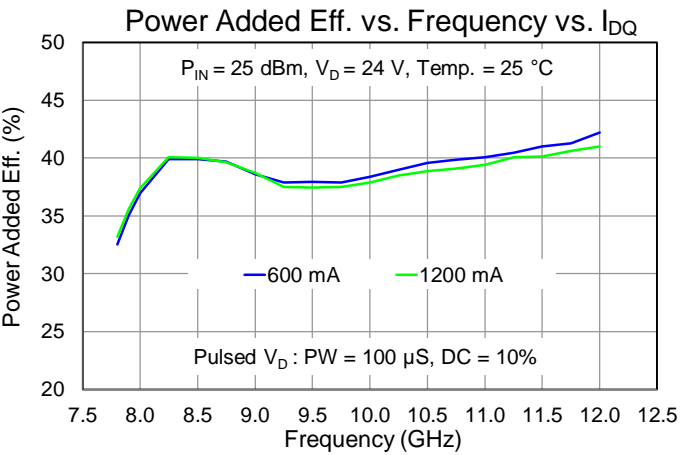
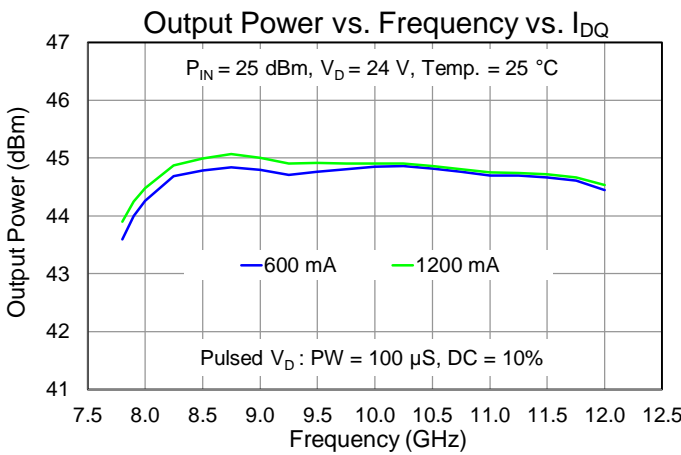
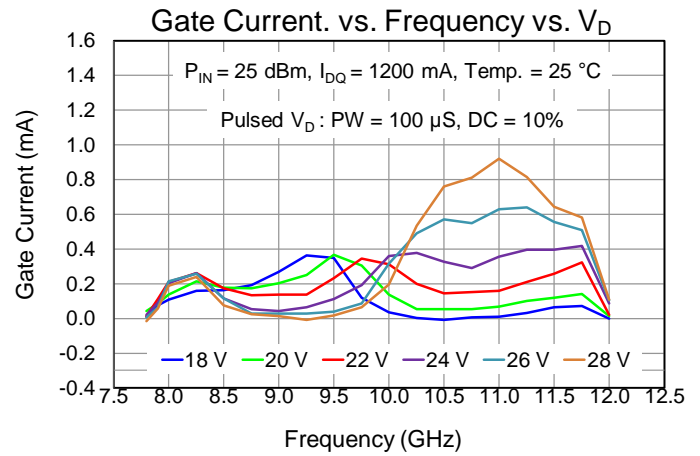
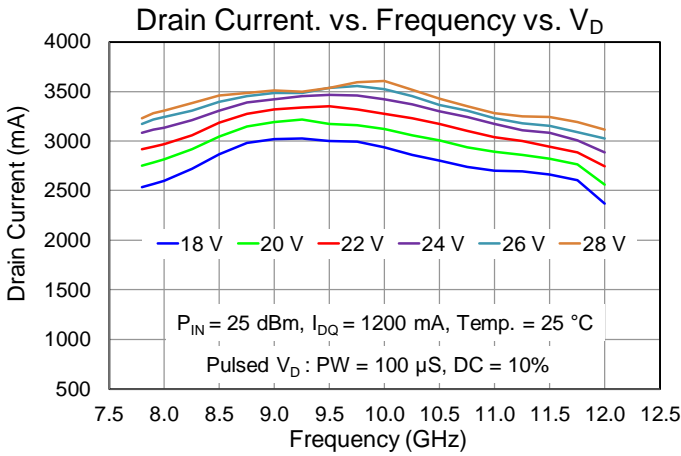

Performance Plots – Large Signal (Pulsed)

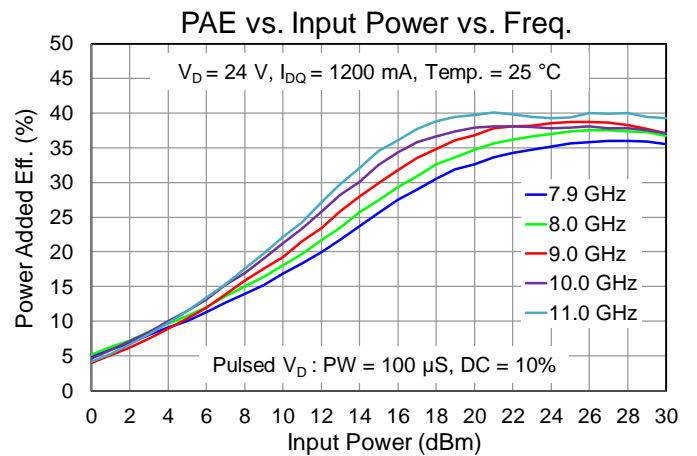
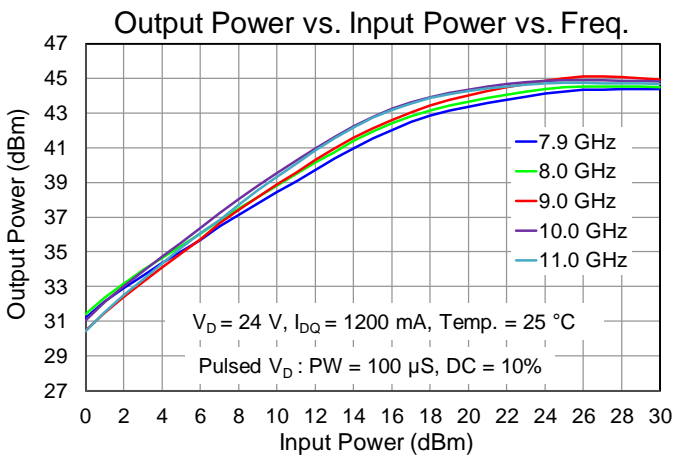
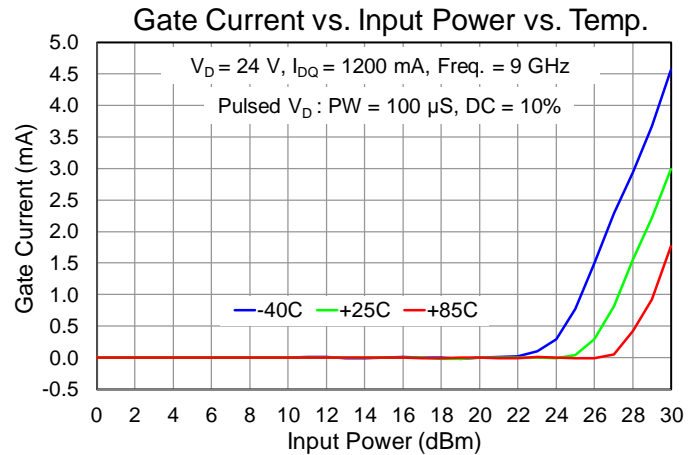
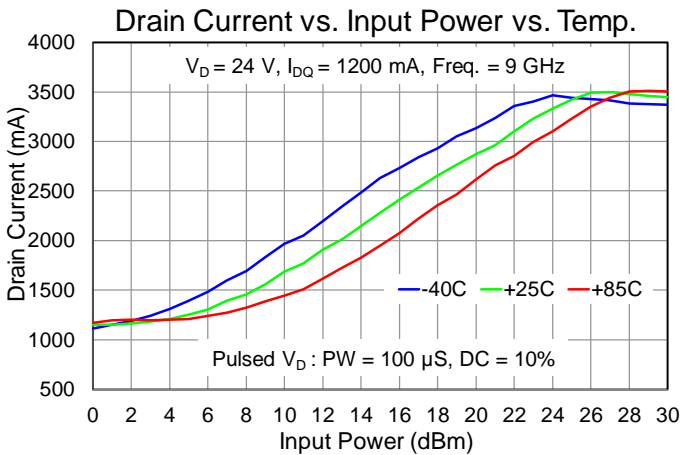
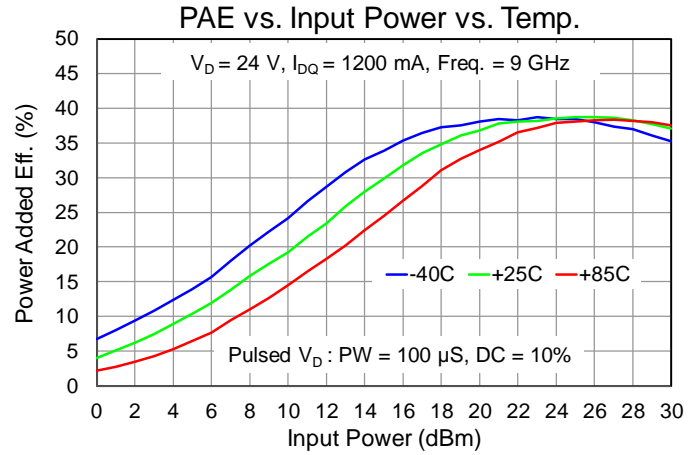
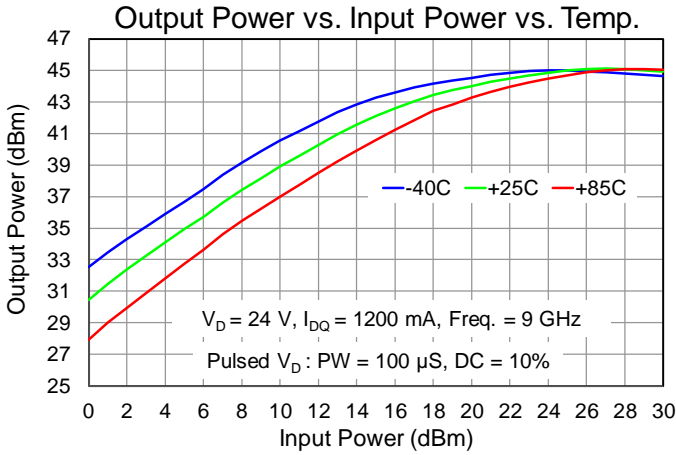

Performance Plots – Large Signal (Pulsed)

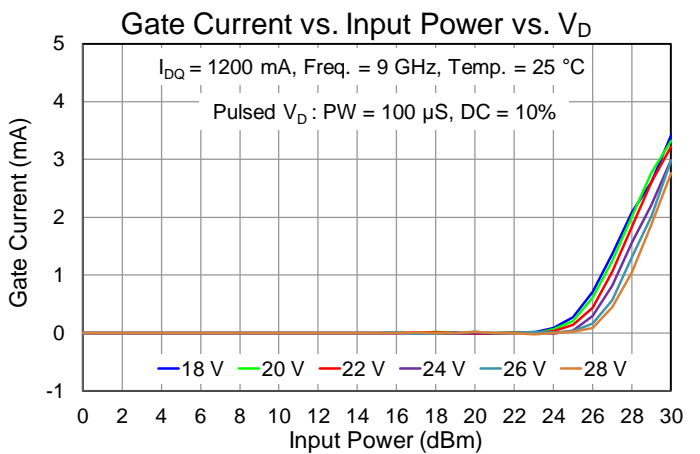
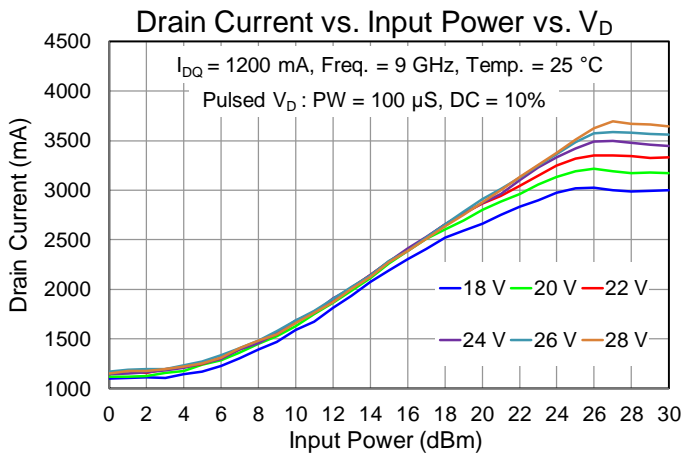
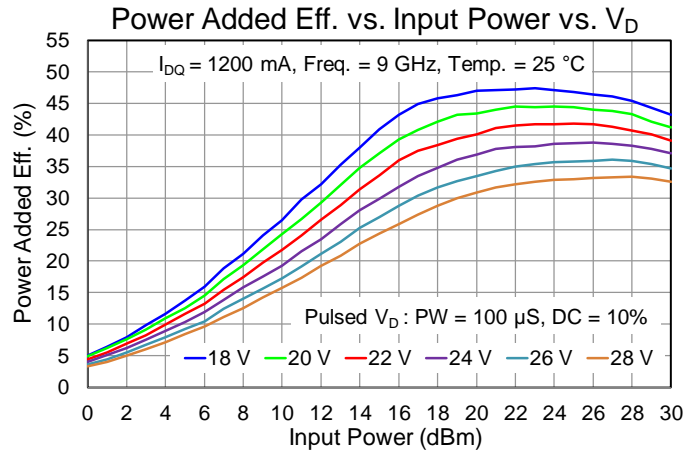
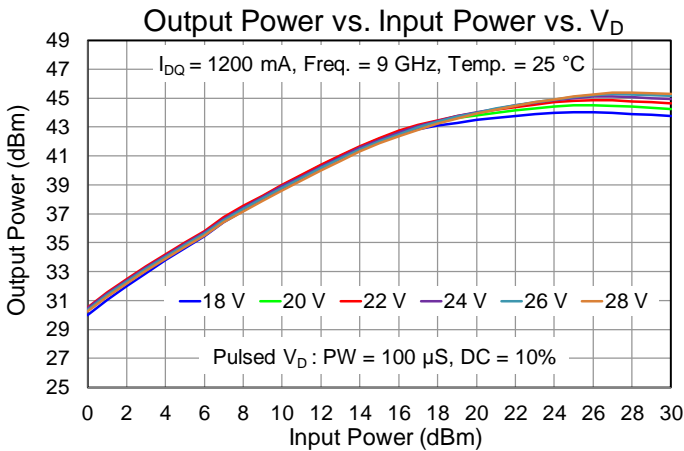
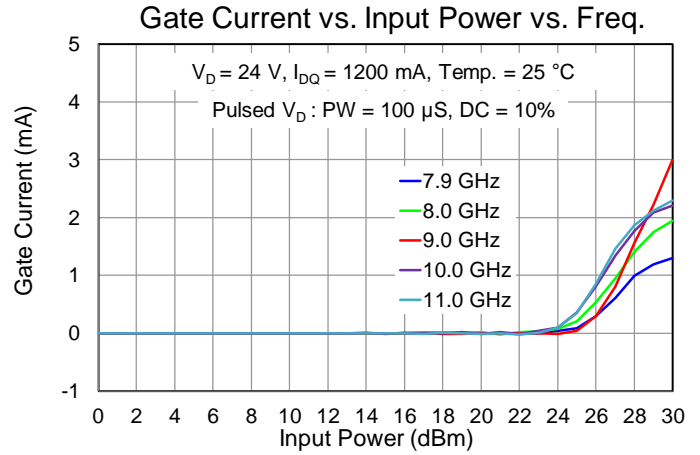
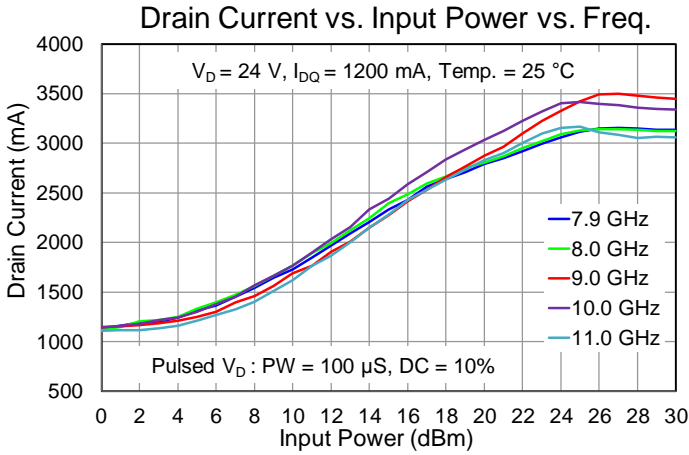

Performance Plots – Large Signal (CW)

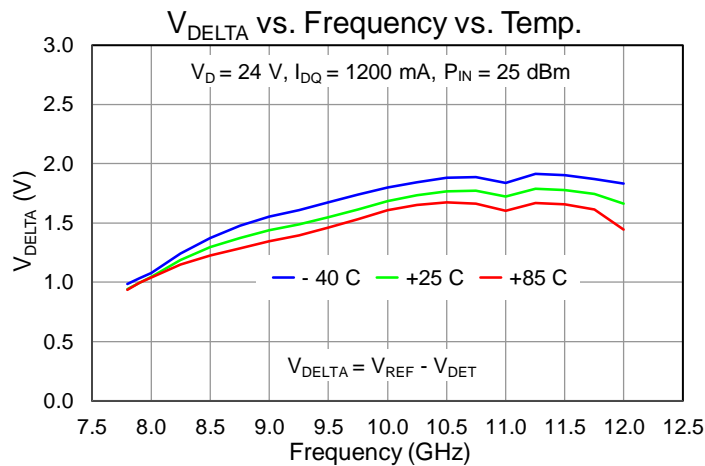
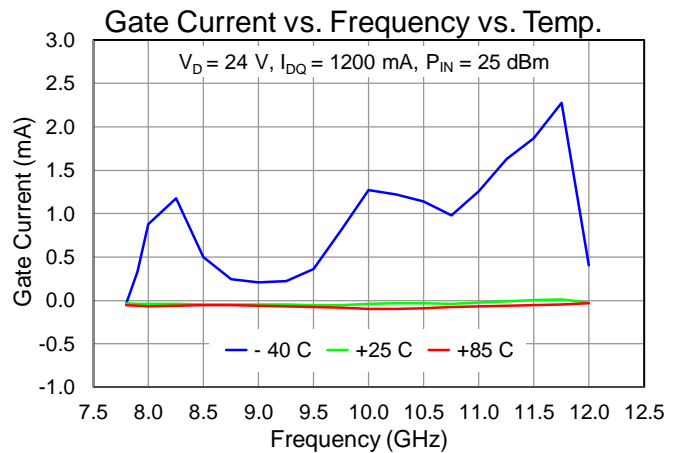
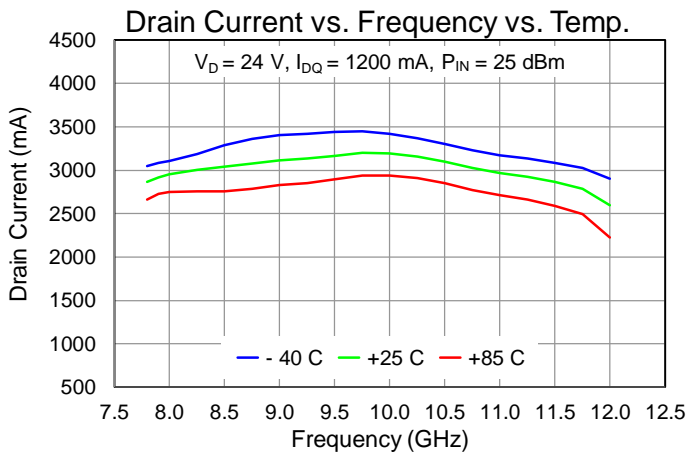
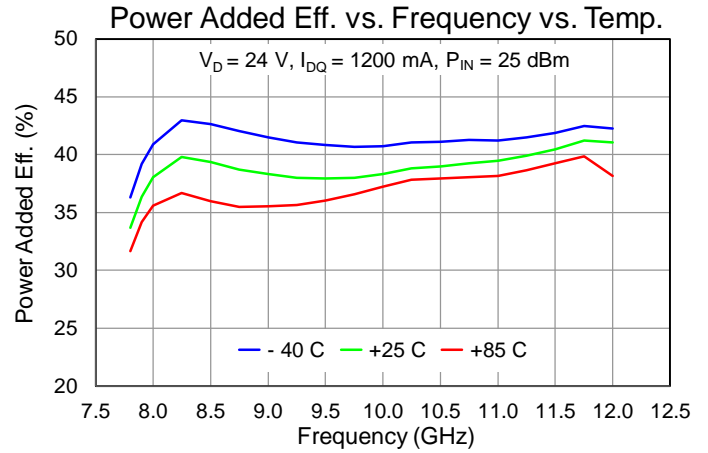
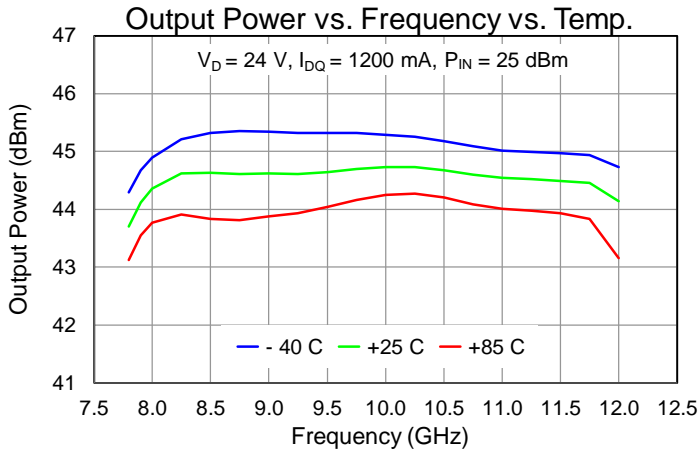

Performance Plots – Large Signal (CW)

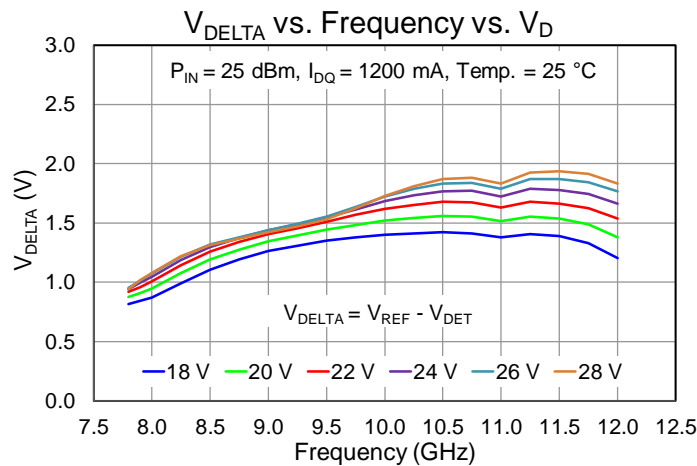
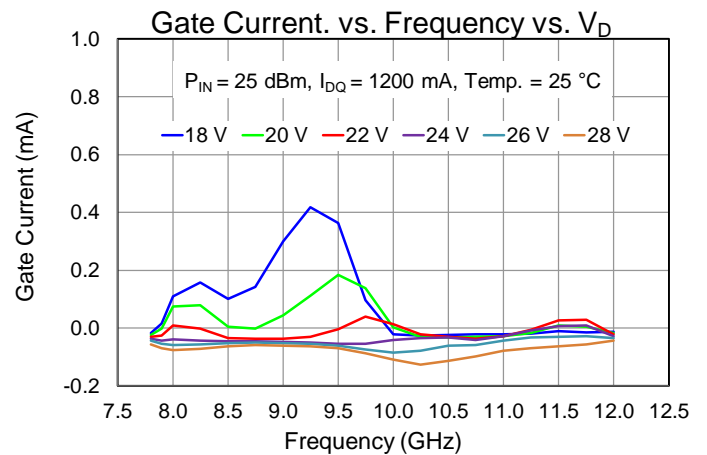
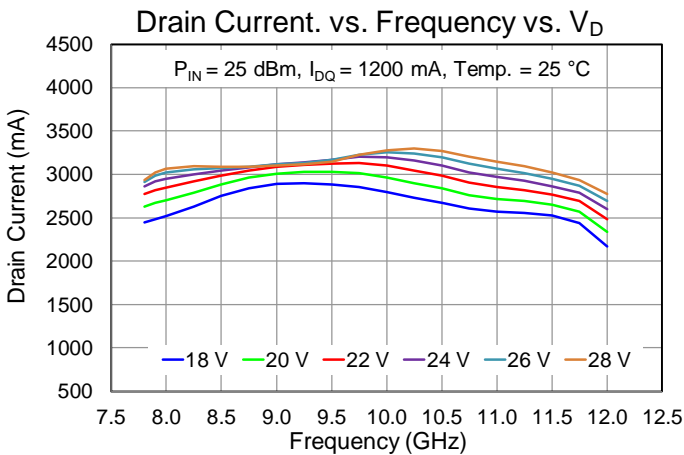
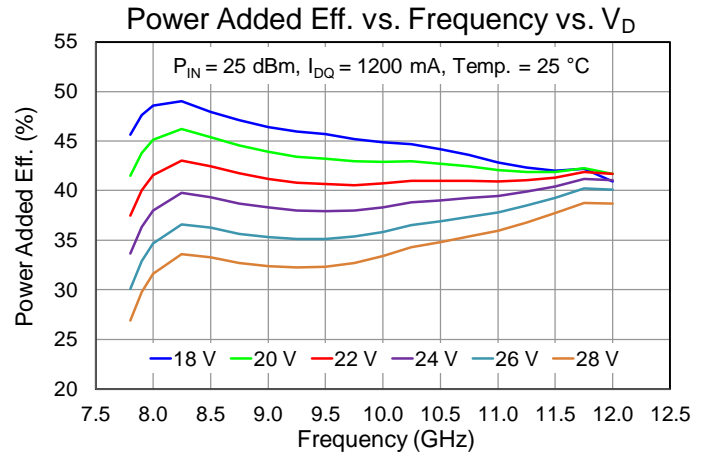
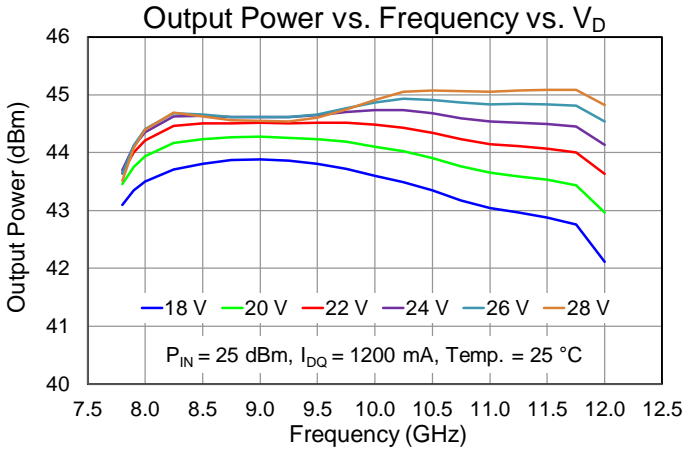

Performance Plots – Large Signal (CW)

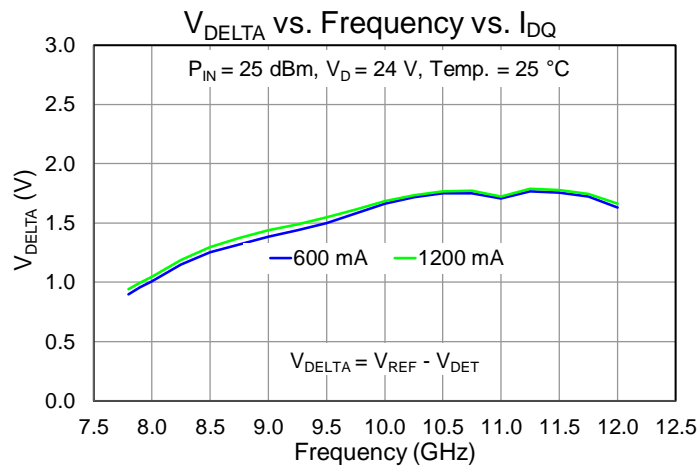
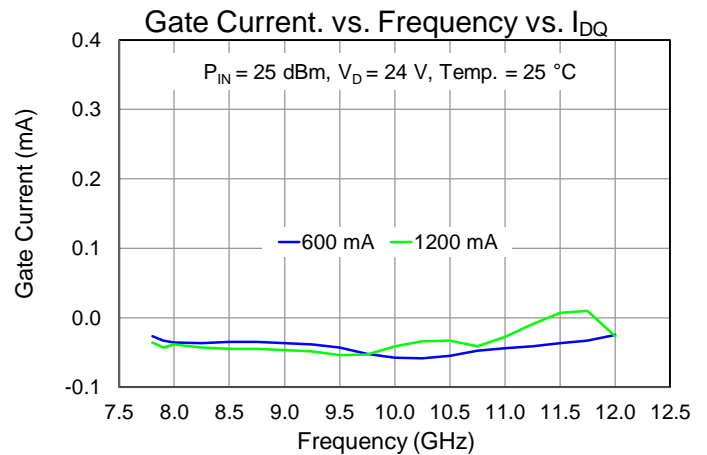
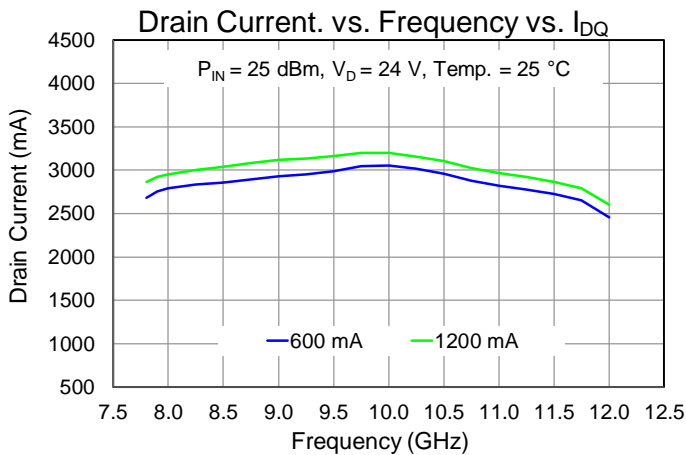
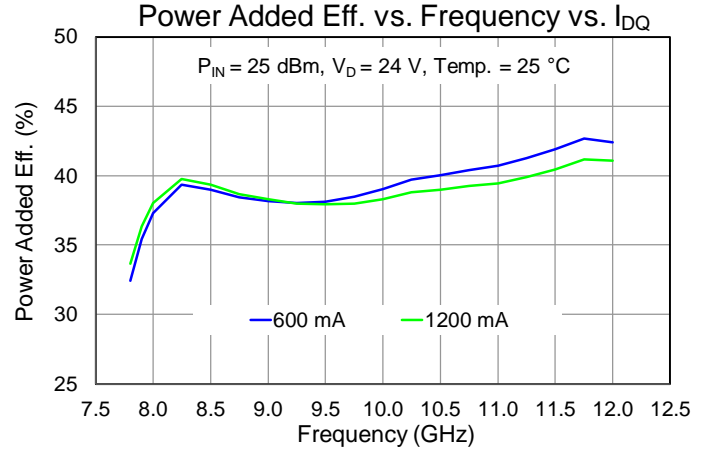
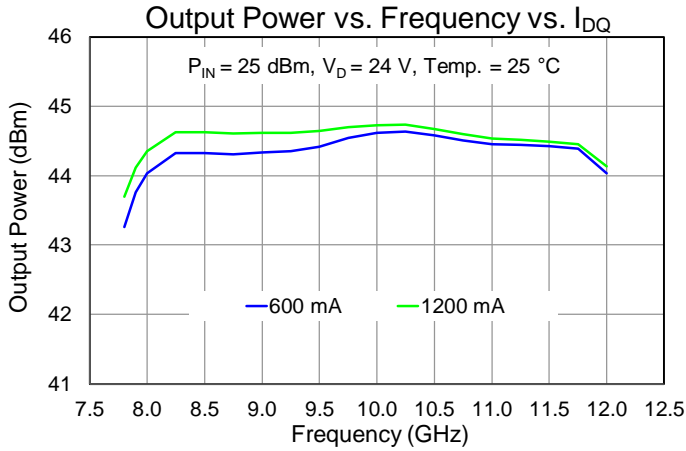

Performance Plots – Large Signal (CW)

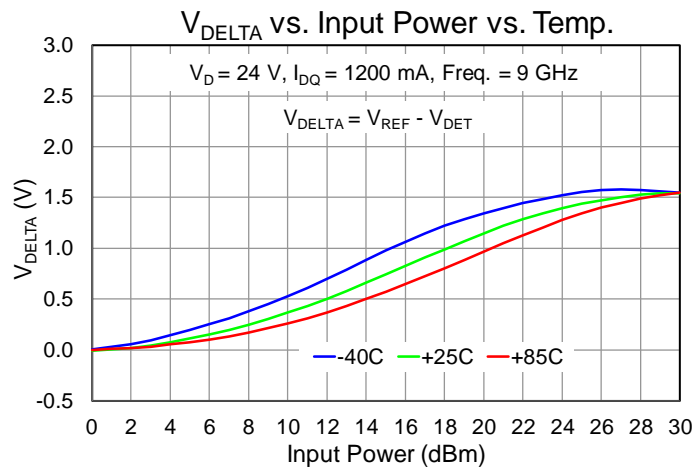
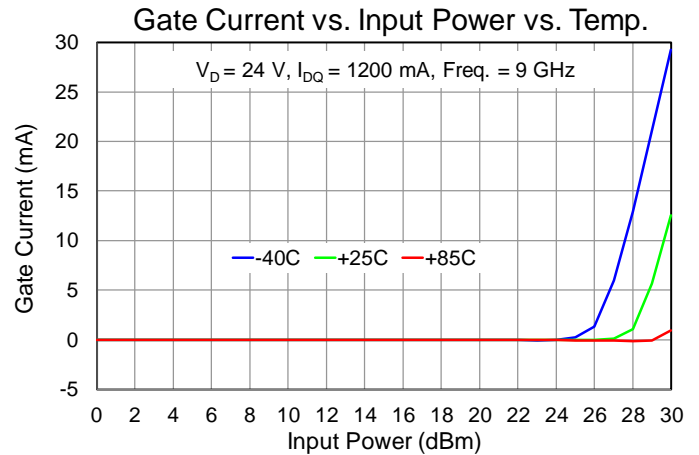
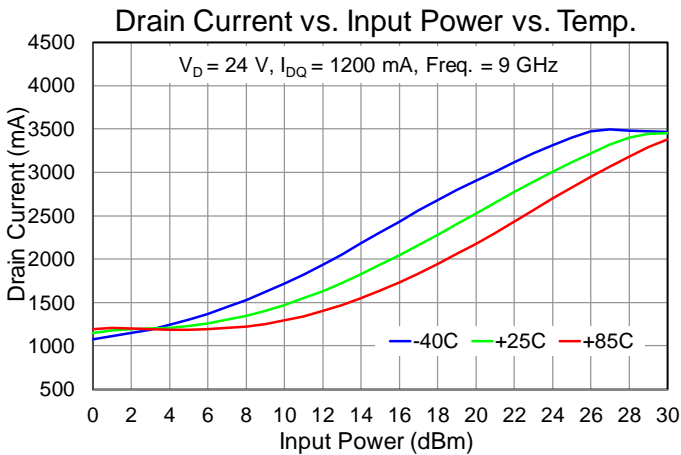
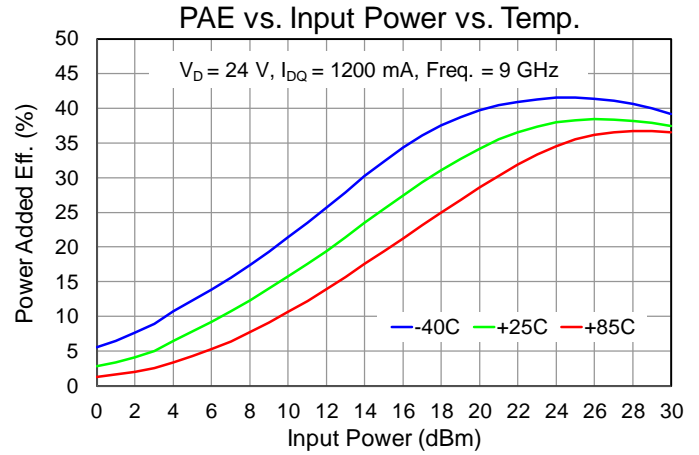
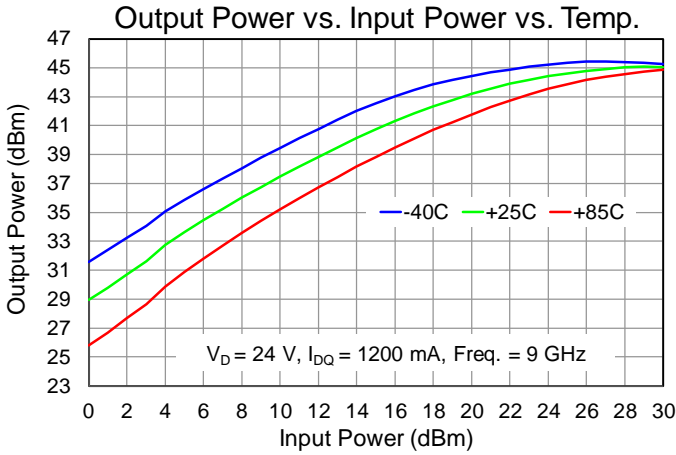

Performance Plots – Large Signal (CW)

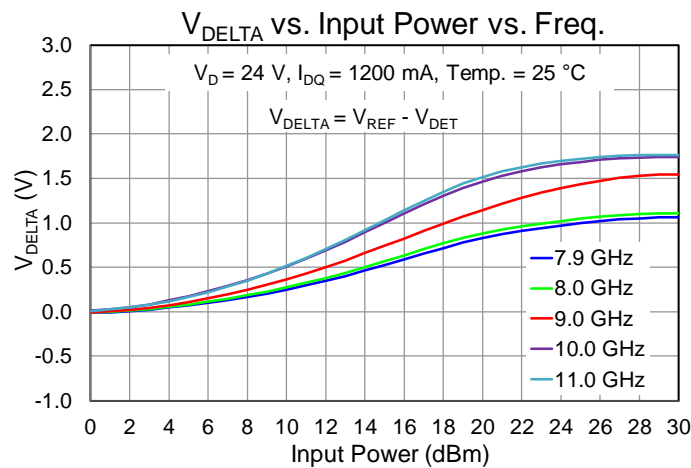
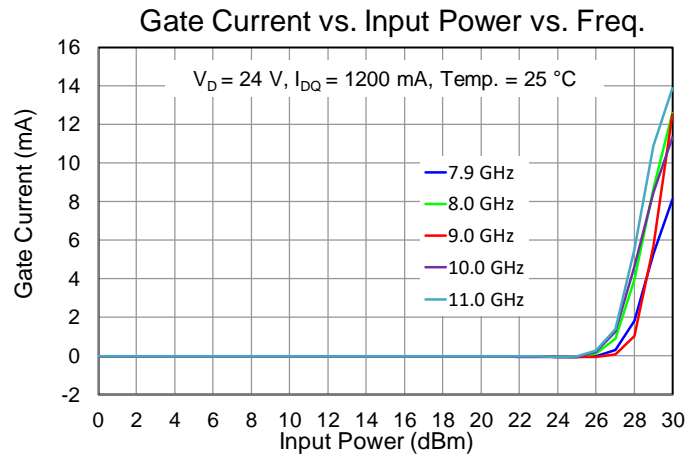
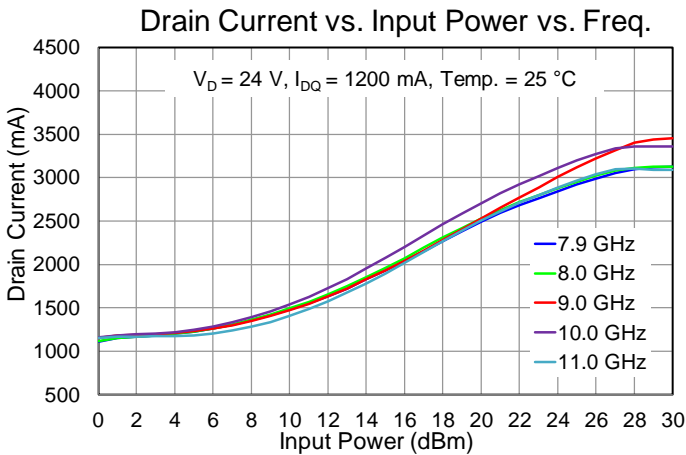
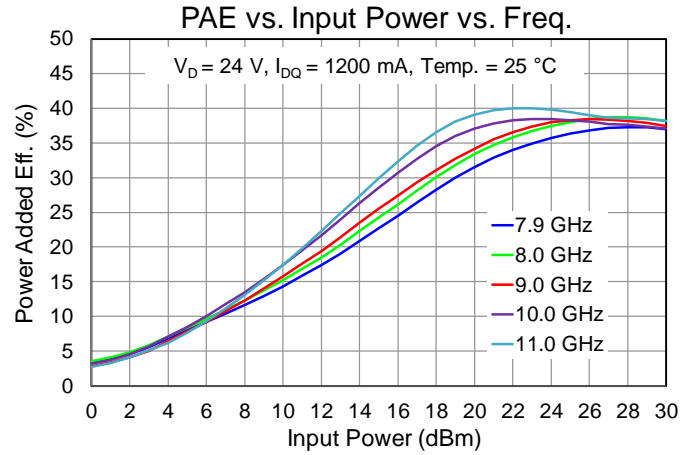
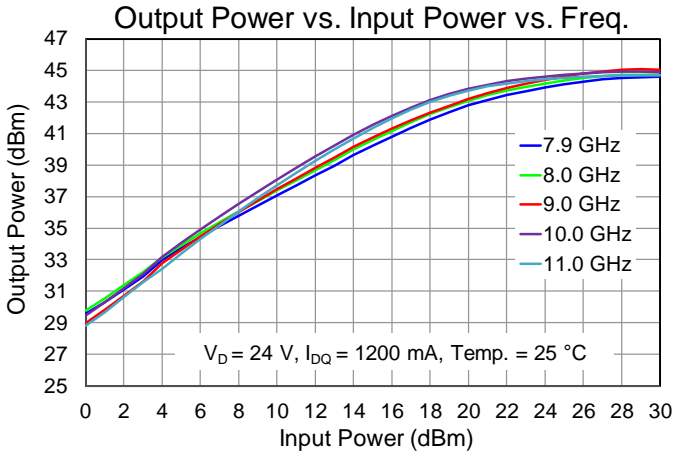

Performance Plots – Large Signal (CW)

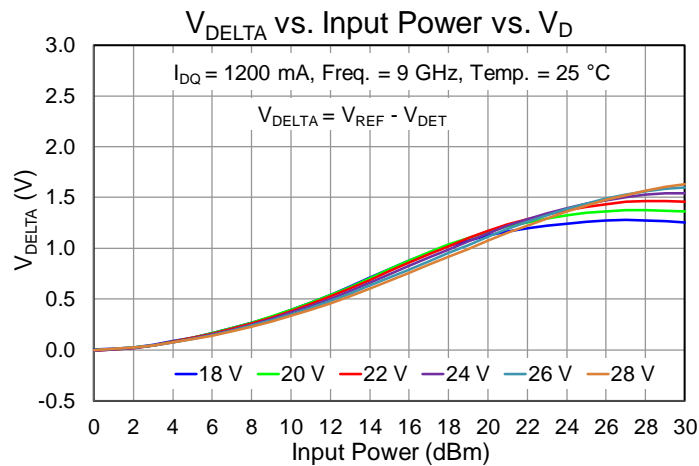
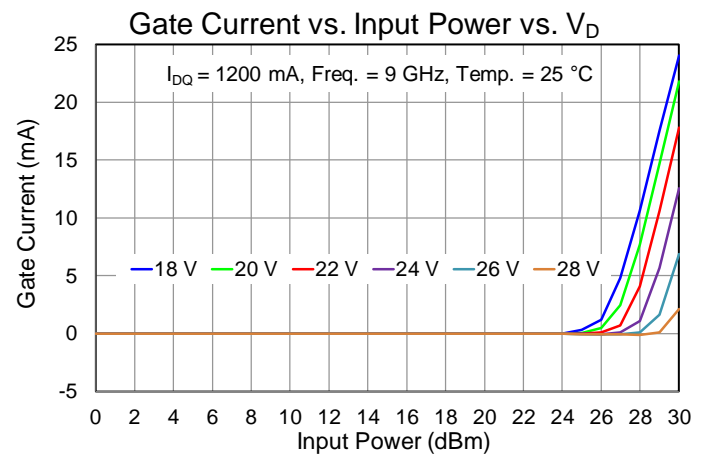
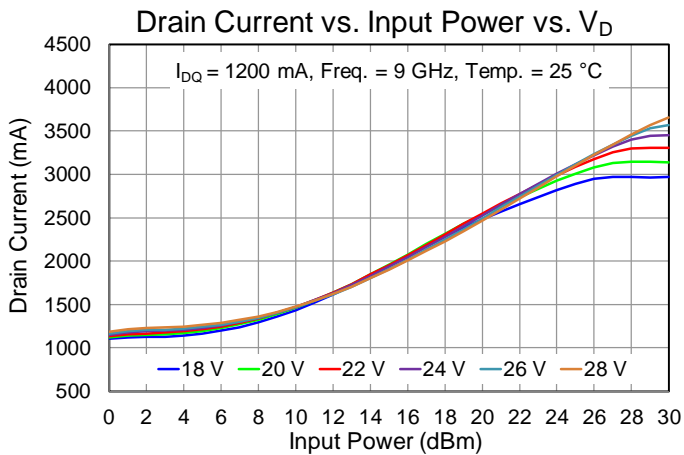
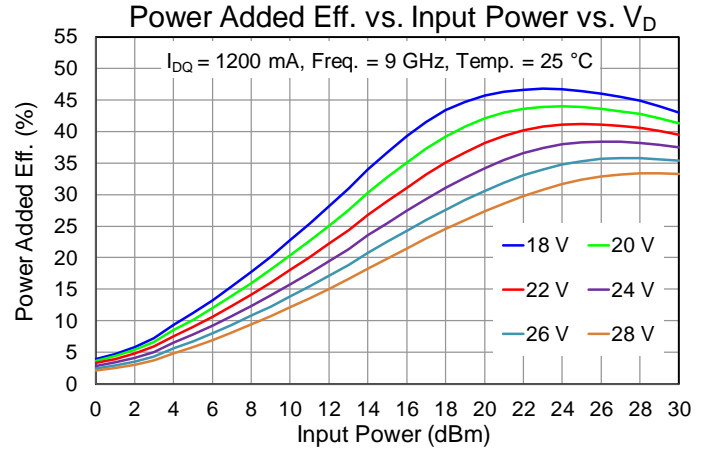
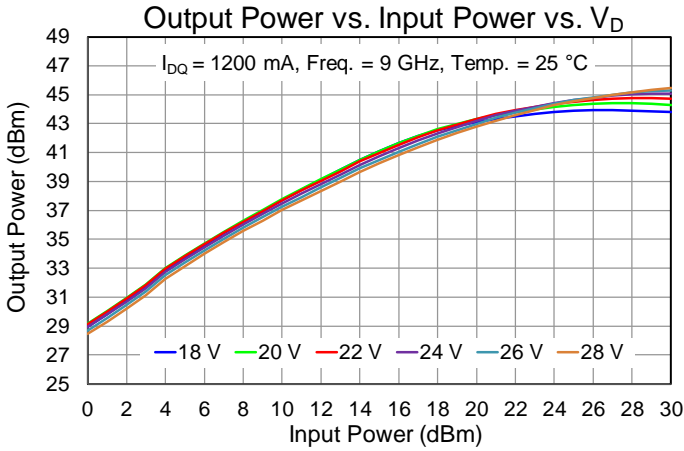

Performance Plots – Linearity

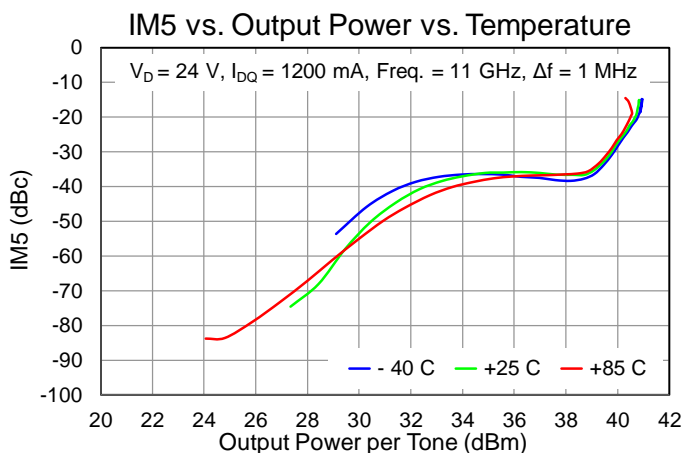
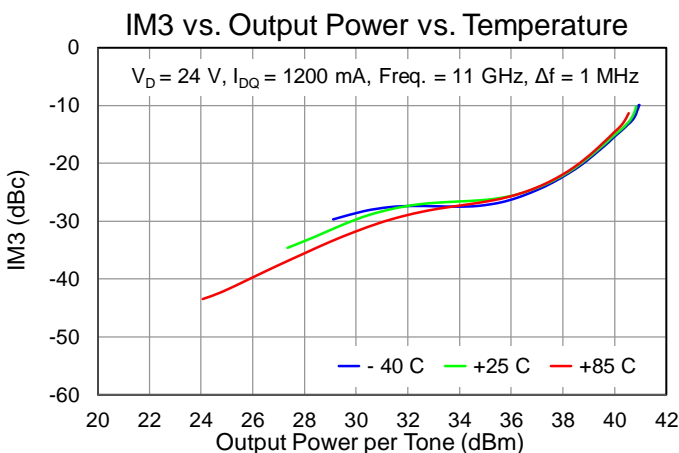
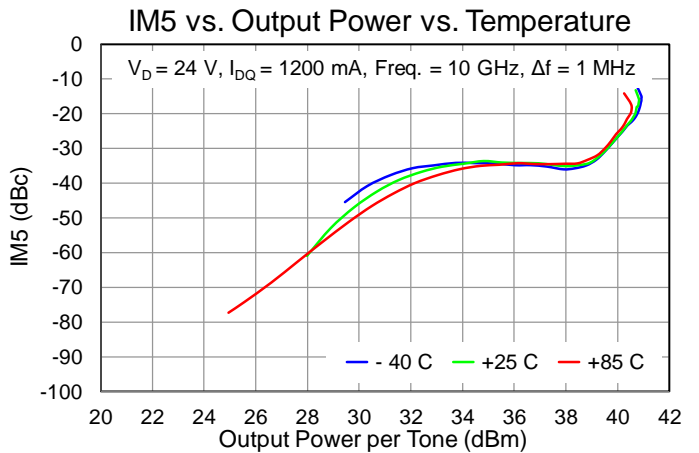
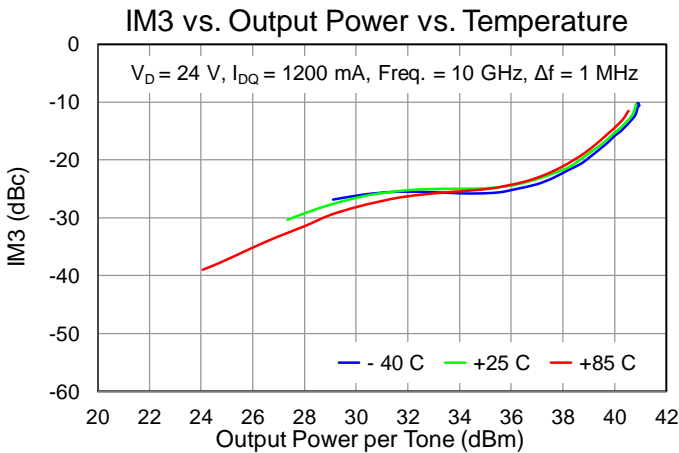
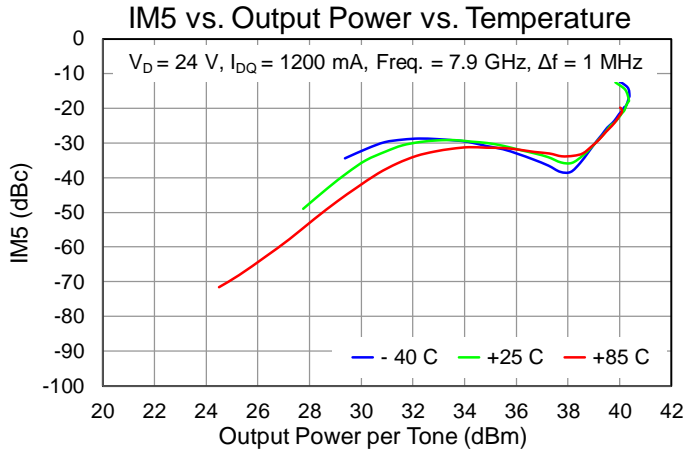
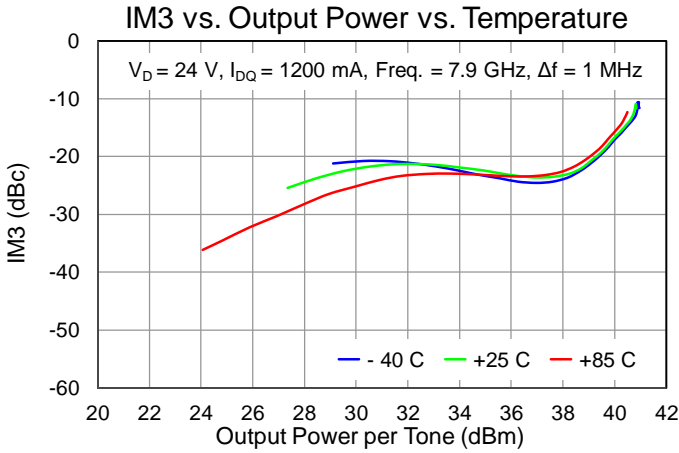

Performance Plots – Linearity

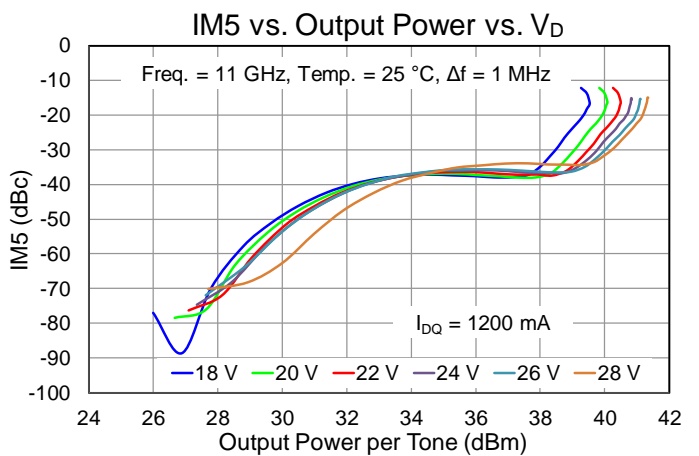
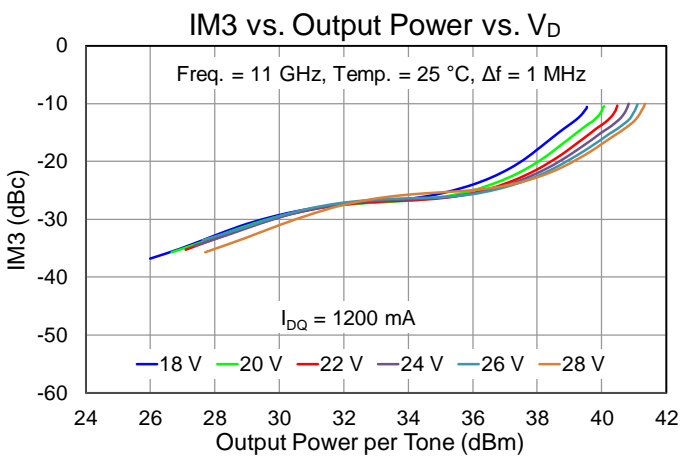
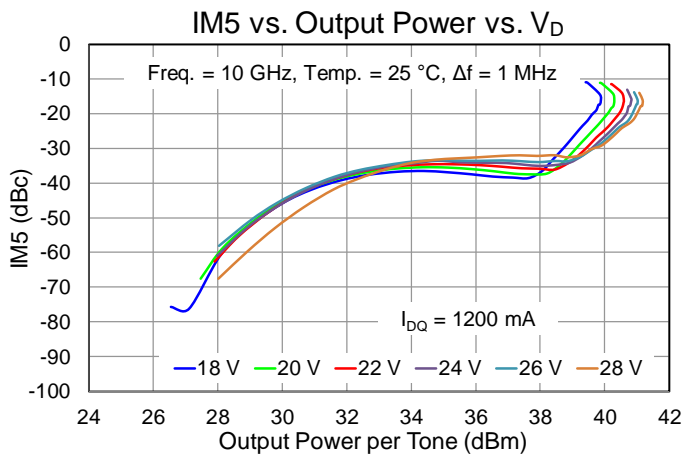
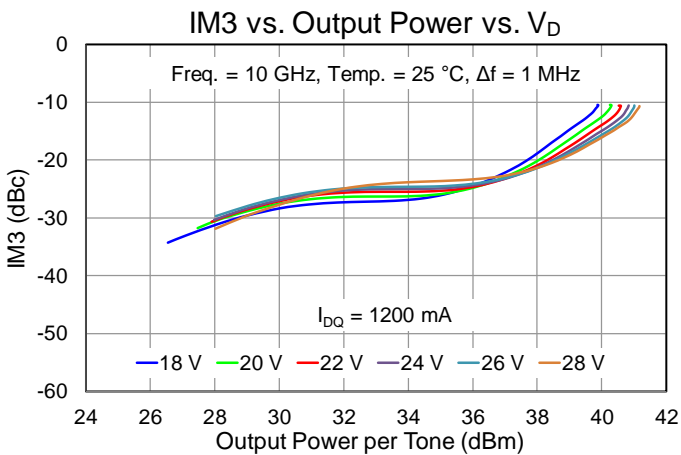
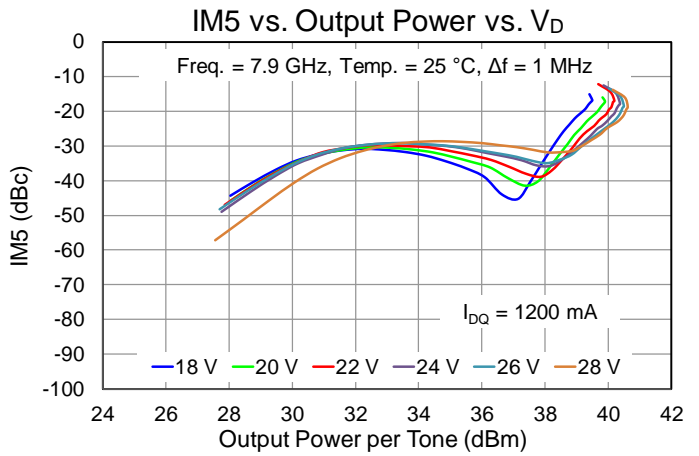
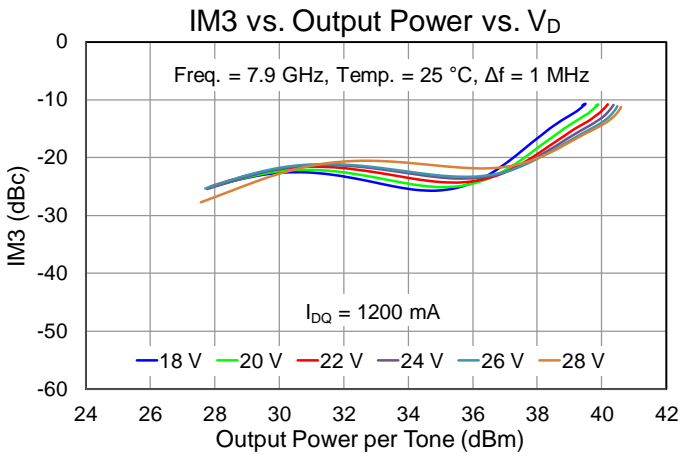

Performance Plots – Linearity

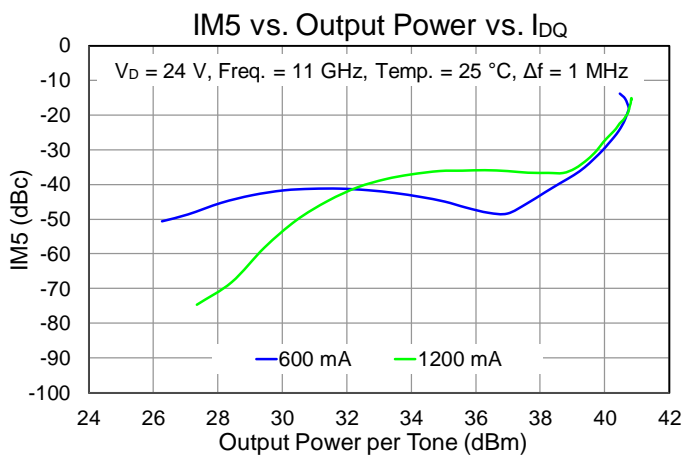
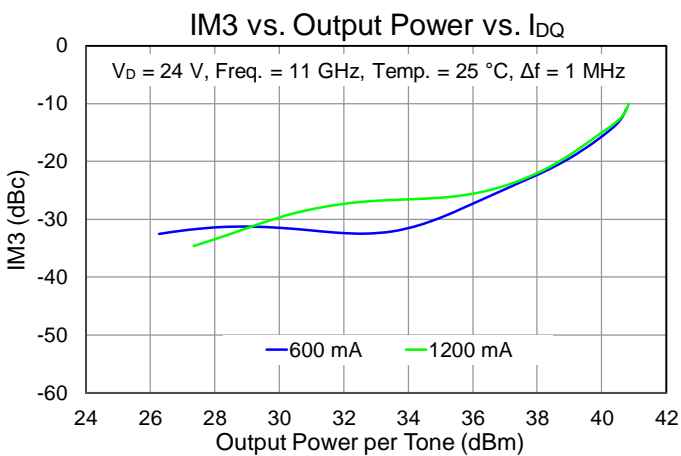
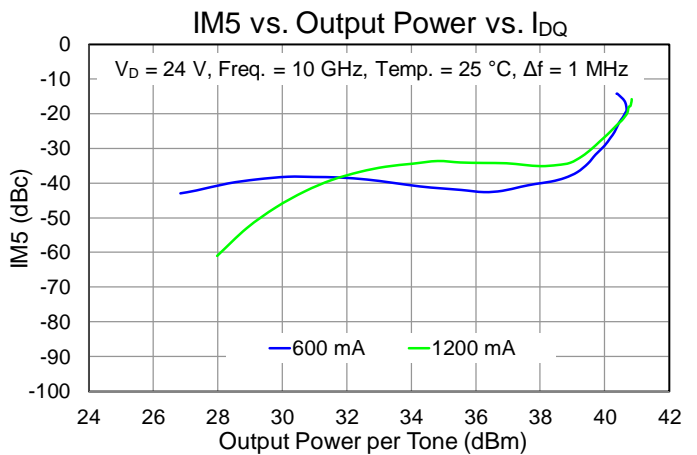
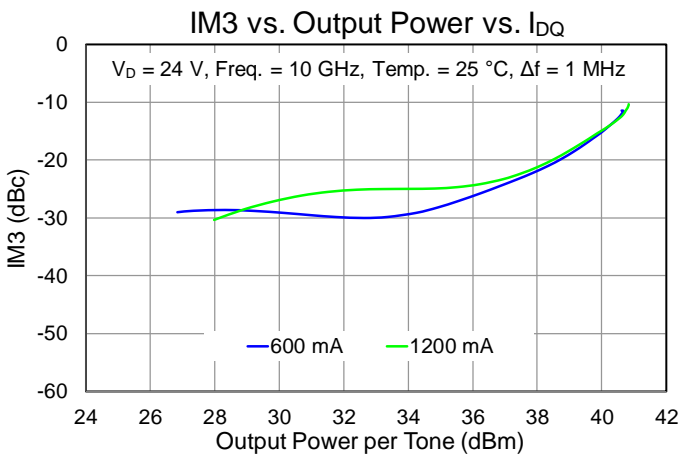
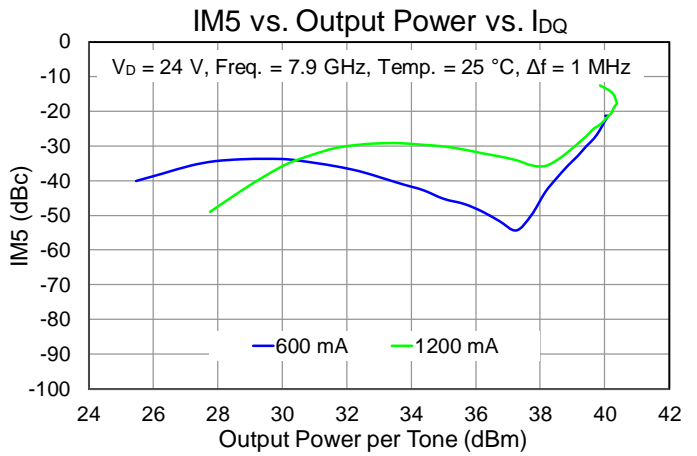
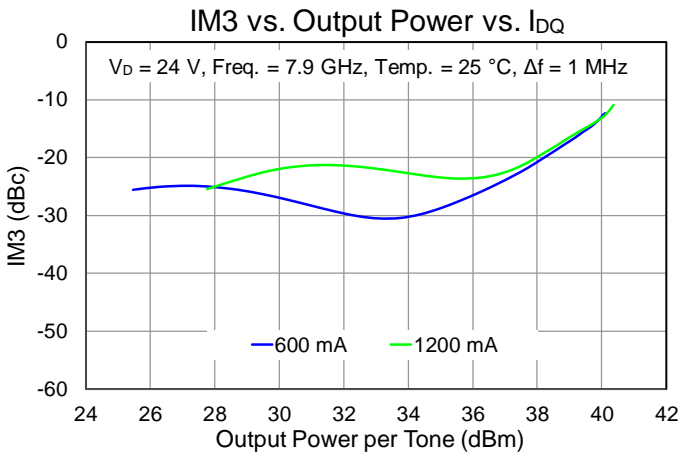

Performance Plots – Linearity

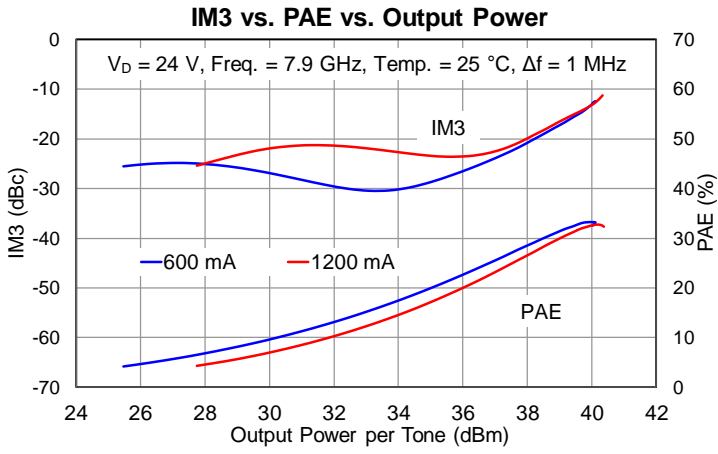
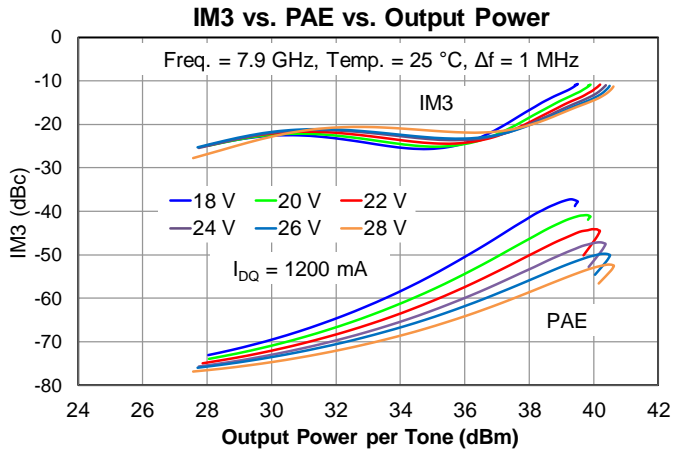

Performance Plots – Harmonics

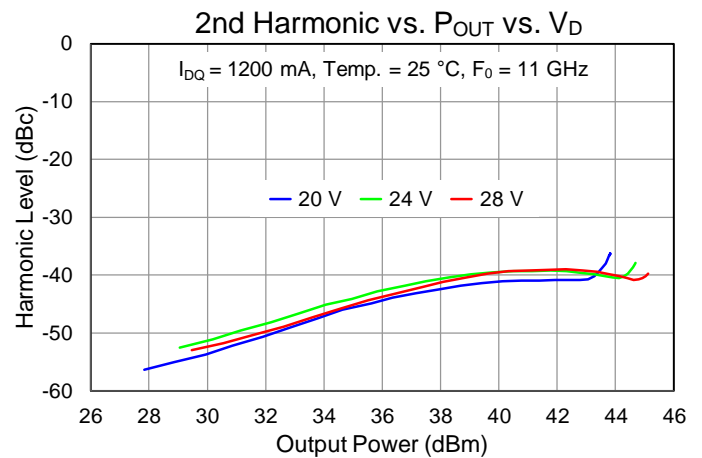
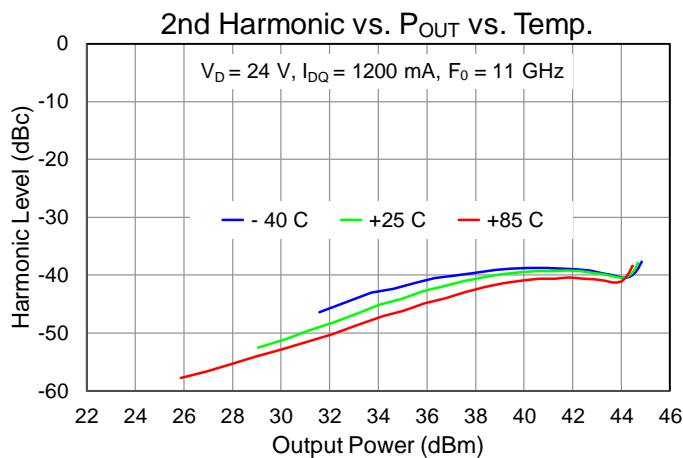
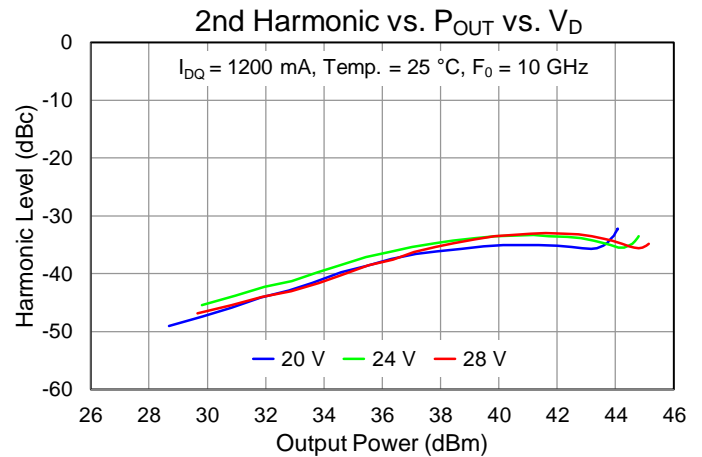
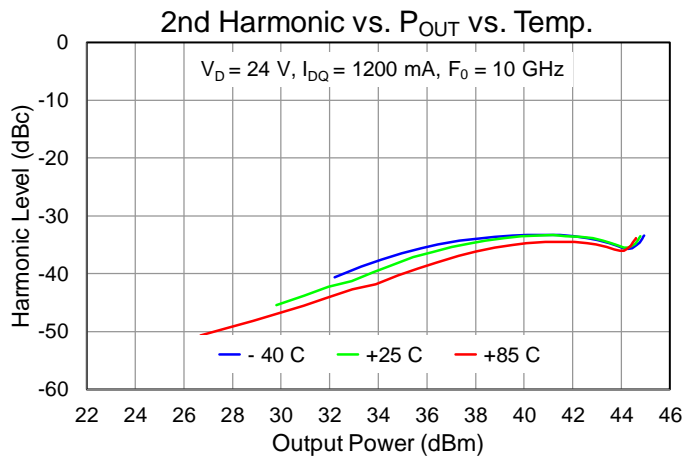
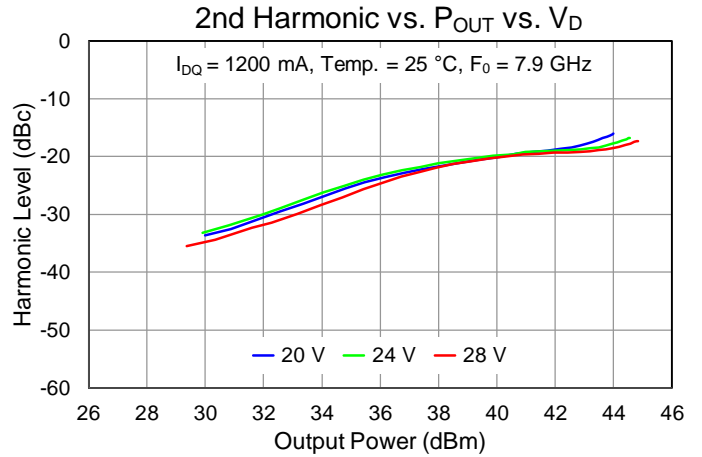
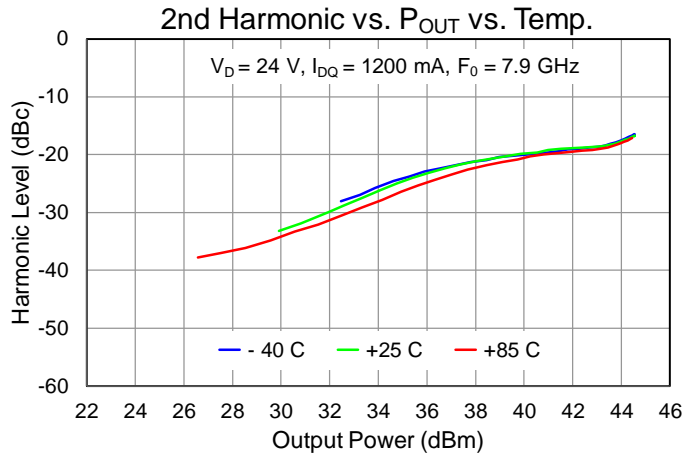

Performance Plots – Small Signal

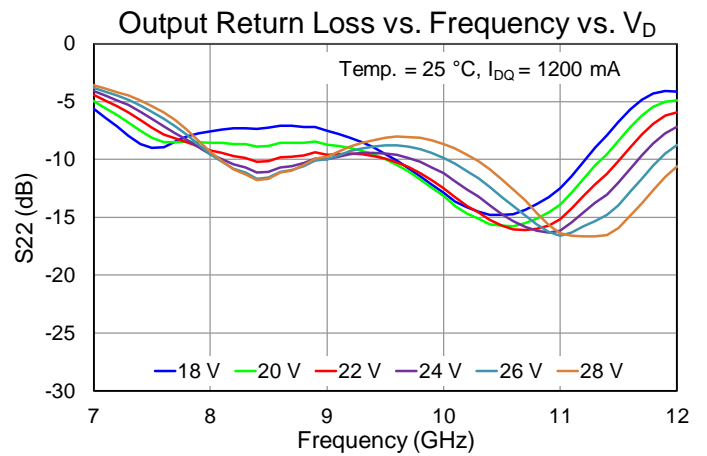
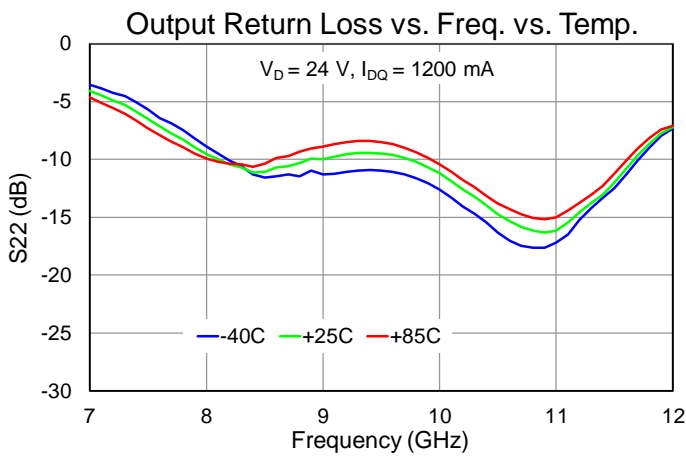
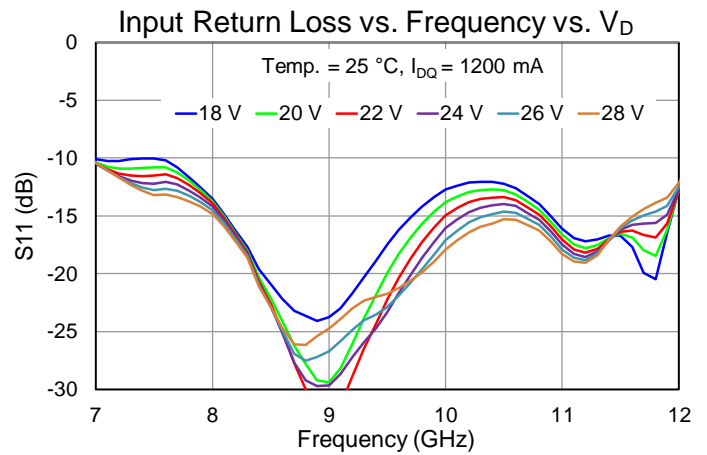
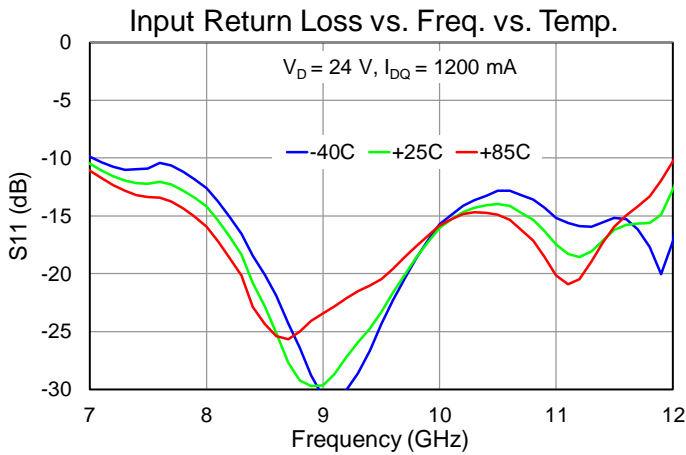
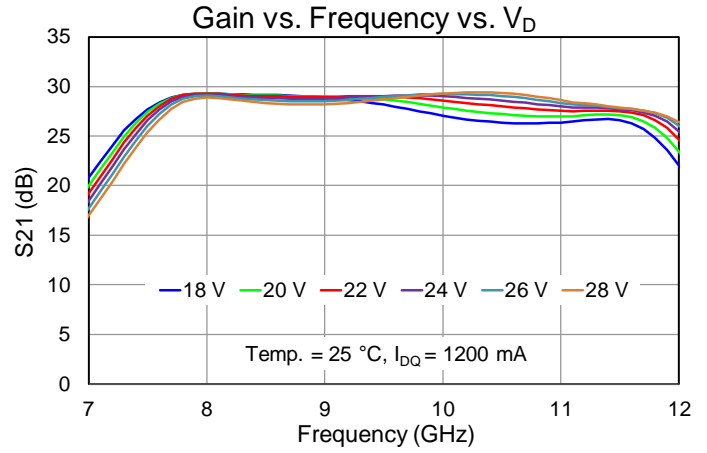
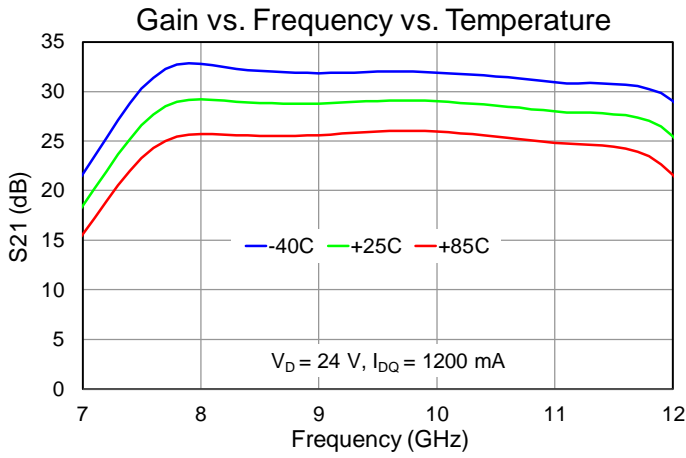

Performance Plots – Small Signal

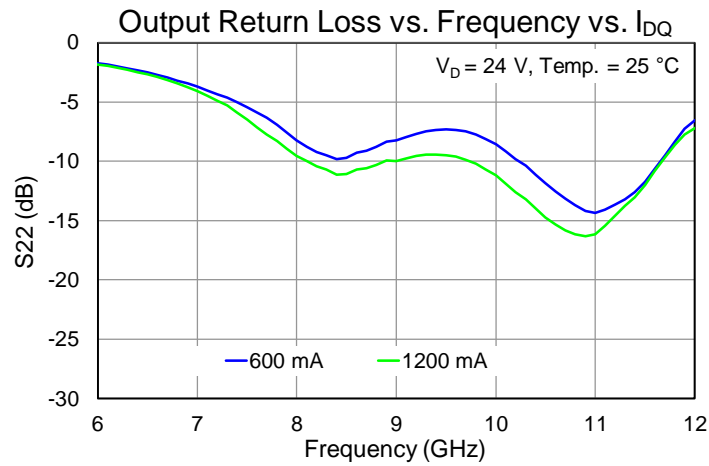
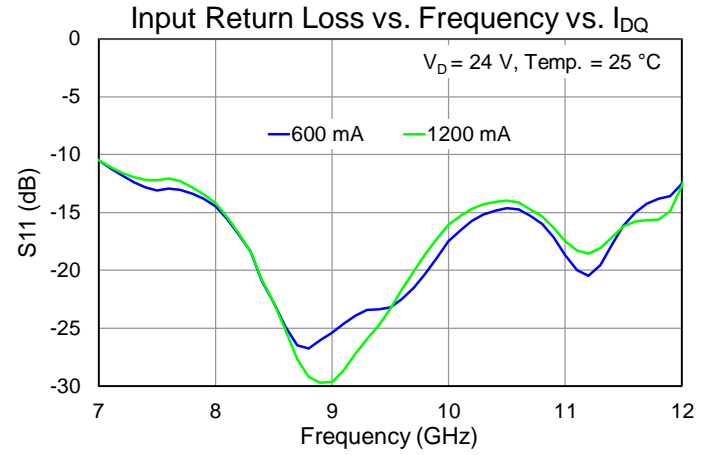
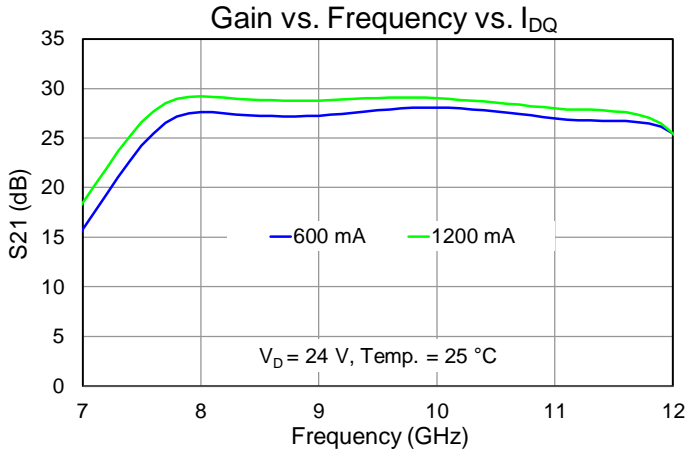

Thermal and Reliability Information

Parameter	Test Conditions	Value	Units
Thermal Resistance (θ_{JC}) ⁽¹⁾	T _{BASE} = 85 °C, V _D = +24 V, I _{DQ} = 1200 mA, Pulsed V _D (100 μ s/10%), Freq = 9.75 GHz, P _{IN} = 25 dBm, I _{D_Drive} = 3.3 A, P _{OUT} = 44.7 dBm, P _{DISS} = 48.9 W	1.0	°C/W
Channel Temperature (T _{CH}) (Under RF drive) ⁽²⁾		134	°C
Thermal Resistance (θ_{JC}) ⁽¹⁾	T _{BASE} = 85°C, V _D = +24V, I _{DQ} = 1200 mA, CW, P _{DISS} = 28.8 W	1.46	°C/W
Channel Temperature (T _{CH}) (No RF) ⁽²⁾		127	°C
Thermal Resistance (θ_{JC}) ⁽¹⁾	T _{BASE} = 85 °C, V _D = +24 V, I _{DQ} = 1200 mA, CW, Freq = 9.75 GHz, P _{IN} = 25 dBm, I _{D_Drive} = 2.9 A, P _{OUT} = 44.2 dBm, P _{DISS} = 44.7 W	1.36	°C/W
Channel Temperature (T _{CH}) (Under RF drive) ⁽²⁾		146	°C
Thermal Resistance (θ_{JC}) ⁽¹⁾	T _{BASE} = 85 °C, V _D = +20 V, I _{DQ} = 1200 mA, Pulsed V _D (100 μ s/10%), Freq = 9.25 GHz, P _{IN} = 25 dBm, I _{D_Drive} = 3.0 A, P _{OUT} = 44.1 dBm, P _{DISS} = 34.6 W	0.95	°C/W
Channel Temperature (T _{CH}) (Under RF drive) ⁽²⁾		118	°C
Thermal Resistance (θ_{JC}) ⁽¹⁾	T _{BASE} = 85°C, V _D = +20V, I _{DQ} = 1200 mA, CW, P _{DISS} = 24 W	1.46	°C/W
Channel Temperature (T _{CH}) (No RF) ⁽²⁾		120	°C
Thermal Resistance (θ_{JC}) ⁽¹⁾	T _{BASE} = 85 °C, V _D = +20 V, I _{DQ} = 1200 mA, CW, Freq = 9.5 GHz, P _{IN} = 25 dBm, I _{D_Drive} = 2.8 A, P _{OUT} = 43.7 dBm, P _{DISS} = 33 W	1.30	°C/W
Channel Temperature (T _{CH}) (Under RF drive) ⁽²⁾		128	°C

Notes:

1. Thermal resistance is referenced to the package backside T_{BASE}
2. IR scan equivalent. Refer to the following document: [GaN Device Channel Temperature, Thermal Resistance, and Reliability Estimates](#)

Power Dissipation and Max Gate Current

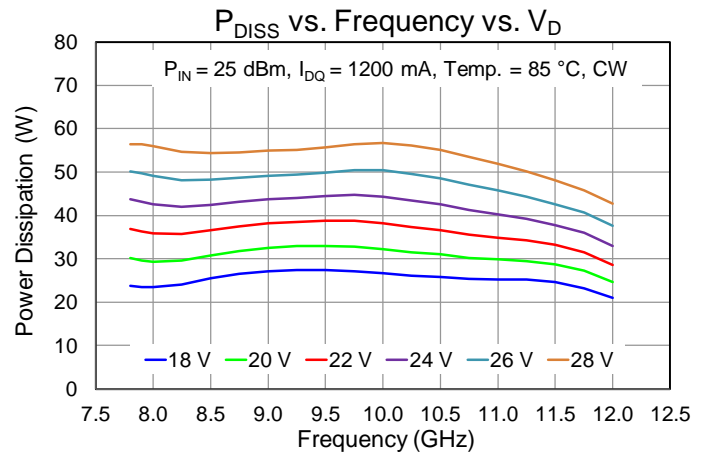
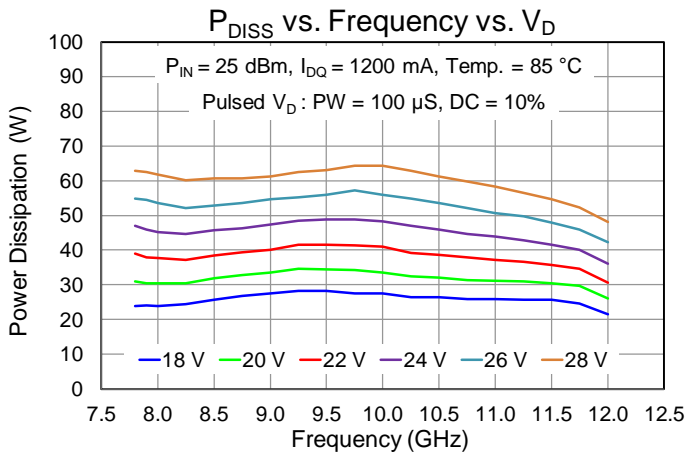
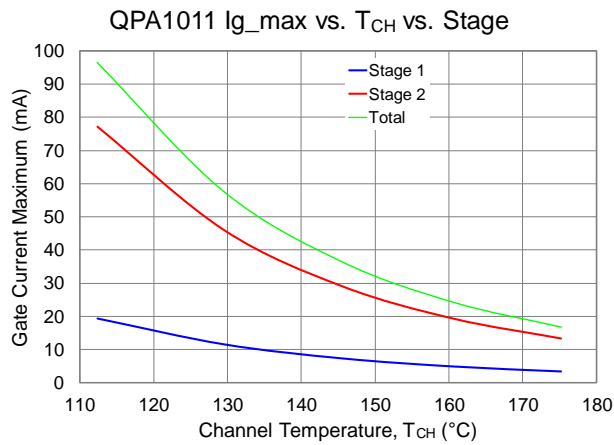

Applications Circuit for Linear and Pulsed Operations

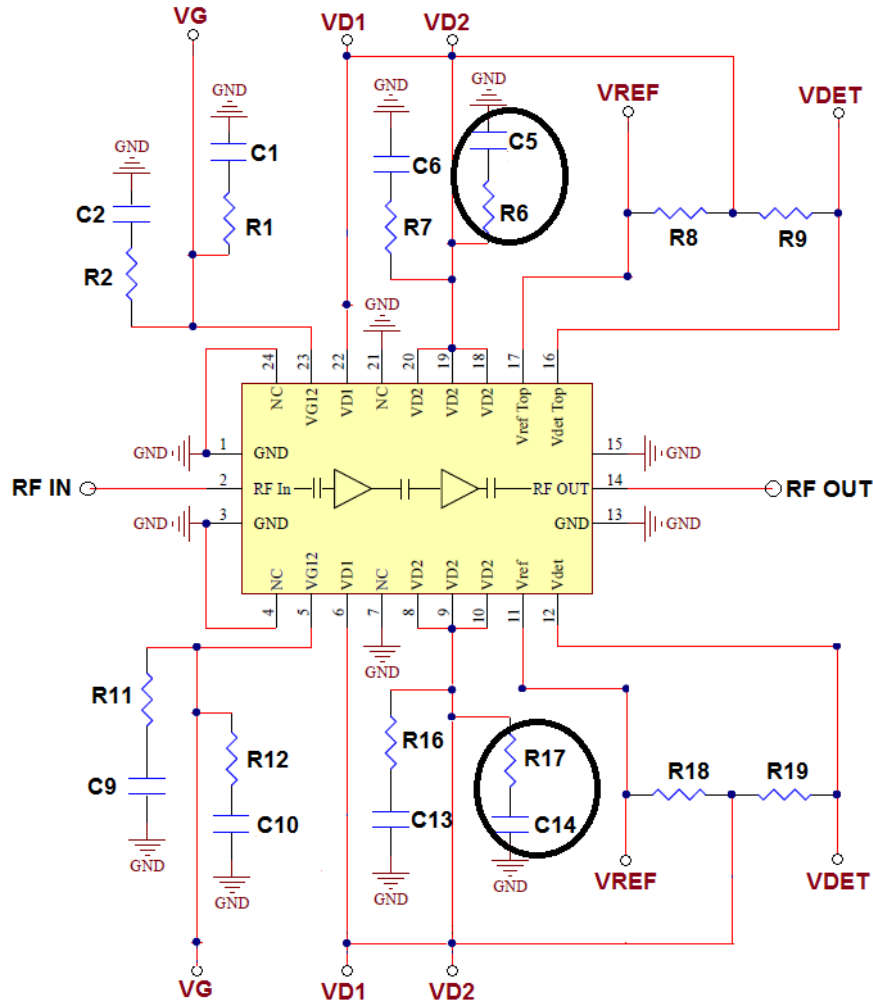

Note: $V_{\Delta} = V_{REF} - V_{DET}$

- QPA1011 can be biased from either the top side or bottom side.
- V_{D1} and V_{D2} need to be tied together
- V_{D1} / V_{D2} and V_{REF} / V_{DET} must be on the same side for V_{Δ} to work.
- Bypassing components required for the side(s) being biased.
- The extra bias components (R6, R17, C5 and C14) are required for optimum linearity.

Bias Up Procedure

1. Set I_D limit to 4000 mA, I_G limit to 20 mA
2. Apply $-5V$ to V_G
3. Apply $+24V$ to V_D ; ensure I_{DQ} is approx. 0 mA
4. Adjust V_G until $I_{DQ} = 1200$ mA ($V_G \sim -1.9$ V Typ.).
5. Turn on RF supply

Bias Down Procedure

1. Turn off RF supply
2. Reduce V_G to $-5V$; ensure I_{DQ} is approx. 0 mA
3. Set V_D to 0V
4. Turn off V_D supply
5. Turn off V_G supply

Evaluation Board (EVB) Layout Assembly for Pulsed Operation

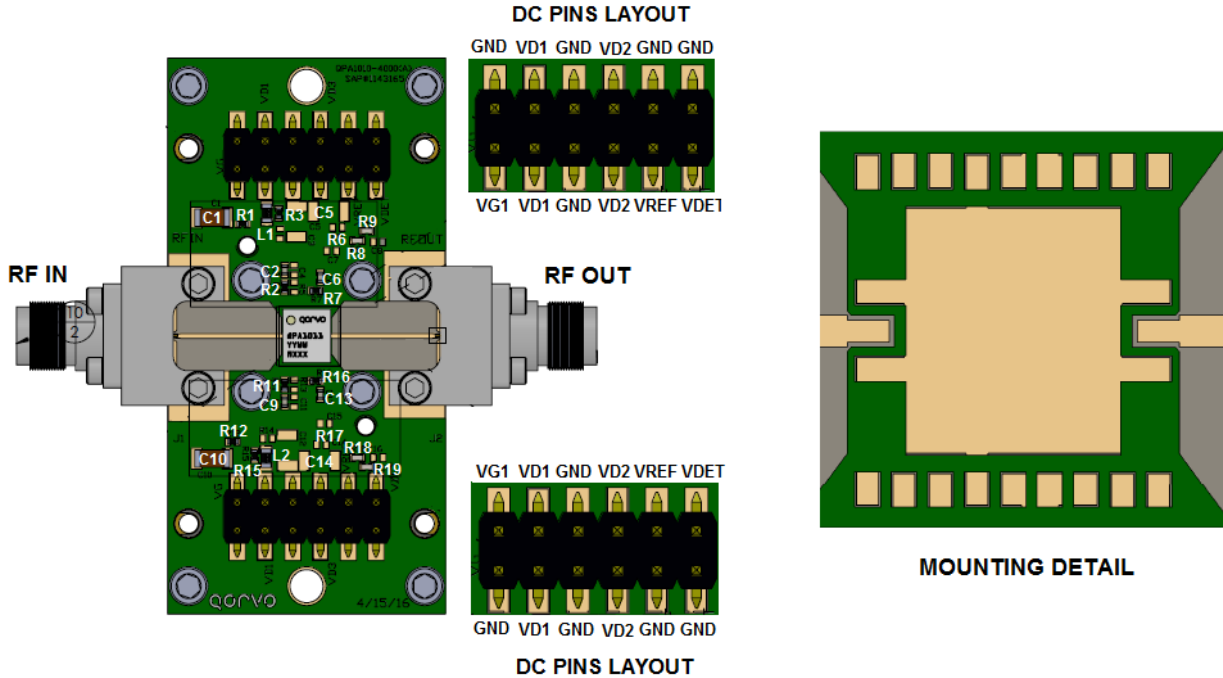

Note: PCB is a multilayer

1. All 4 metal thicknesses are 0.5 oz
2. Upper core 1 is Rogers 4003C, 8 mil thick
3. Lower core 2 is 370HR, 6 mil thick
4. Pre-Preg is an epoxy coated glass fabric
5. Total finished PCB thickness is 25 ±3 mil
6. This EVB uses a copper-coined PCB for optimum thermal management under high dissipation long pulse and/or CW conditions

Bill of Materials for EVB

Reference Des.	Value	Description	Manuf.	Part Number
C1, C5, C10, C14	10 uF	CAP, 1206, 50 V, 20 %, X5R	Various	–
C2, C6, C9, C13	0.01 uF	CAP, 0402, 50 V, 10 %, X7R	Various	–
R1, R12	5.1 Ohm	RES, 0402, 50V, 5 %, SMT	Various	–
R2, R3, R6, R7, R11, R15, R16, R17 ⁽¹⁾	0 Ohm	RES, 0402, 5 %, SMD	Various	–
R8, R9, R18, R19	25.5 K Ohm	RES, 0402, 1/16W, 1%, 0402	Various	–
L1, L2 ⁽¹⁾	0 Ohm	RES, 0603, 1/10 W	Various	–

Note:

1. These components are acting as the jumpers for this EVB.

Mechanical Information

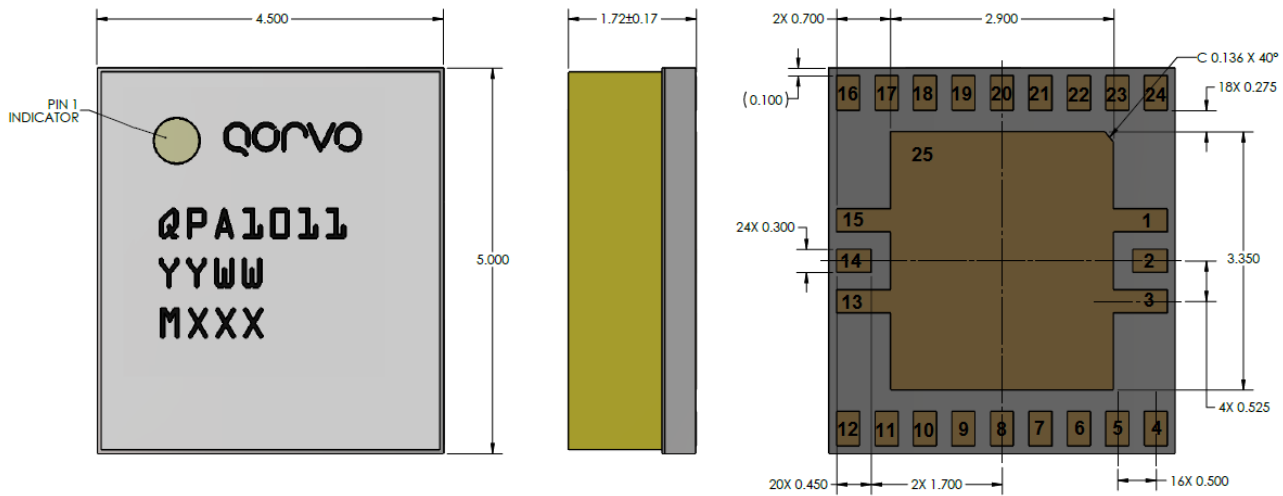

Units: millimeters
 Tolerances: unless specified
 x.xx = ± 0.25
 x.xxx = ± 0.100
 Materials:
 Base: Laminate
 Lid: FR4
 All metalized features are gold plated
 Part is epoxy sealed
 Marking:
 QPA1011: Part number
 YY: Part Assembly year
 WW: Part Assembly week
 MXXX: Batch ID

Pin Description

Pad No.	Symbol	Description
1, 3, 13, 15, Center	GND	Ground. Must be grounded on the PCB. Conductive filled vias recommended for least inductance and improved thermal performance
2	RF _{IN}	RF Input; matched to 50 Ω; DC blocked
4, 7, 21, 24	N/C	Not connected internally. Recommended to be grounded
5, 23	V _{G1-2}	Stage 1-2 Gate Voltage. Bias network is required; see recommended Application Information above on page 21
6, 22	V _{D1}	Stage 1 Drain Voltage. Bias network is required; see recommended Application Information above on page 21
8 – 10, 18 - 20	V _{D2}	Stage 2 Drain voltage; Bias network is required; must be biased from both sides; see recommended Application Information above on page 21
11, 17	V _{REF}	Reference voltage
12, 16	V _{DET}	Detector voltage
14	RF _{OUT}	RF Output; matched to 50 Ω; DC blocked

Tape and Reel Information

Standard T/R size: 100 or 250 pieces on a 7" reel
 Dimensions unless otherwise noted: millimeters (mm)
 Tolerances unless otherwise noted: ± 0.1

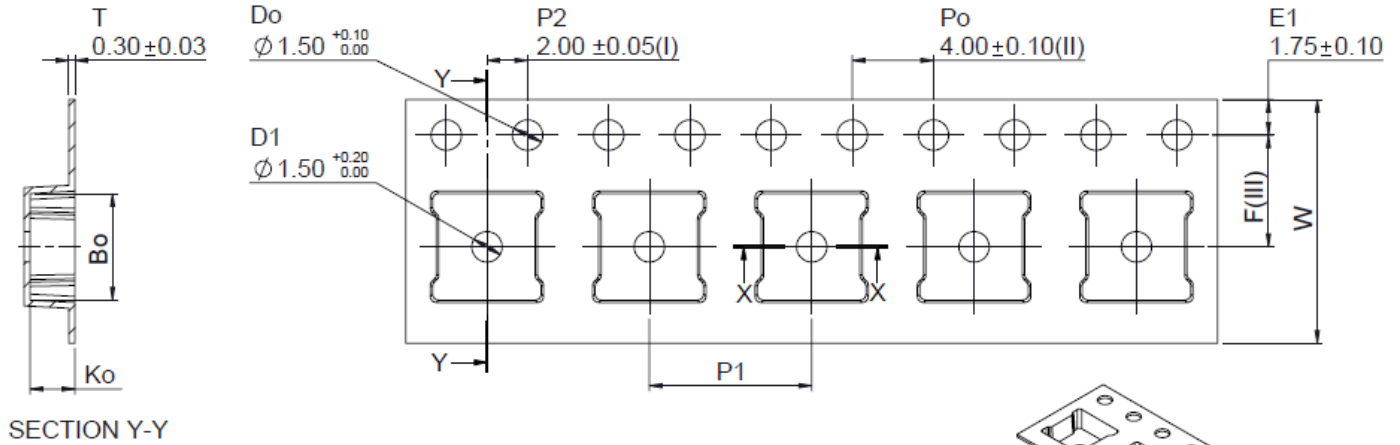

SECTION Y-Y

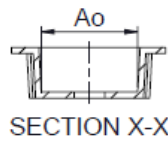

SECTION X-X

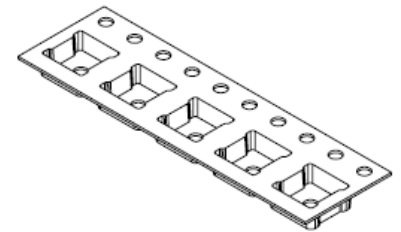

- (I) Measured from centreline of sprocket hole to centreline of pocket.
- (II) Cumulative tolerance of 10 sprocket holes is ± 0.20 .
- (III) Measured from centreline of sprocket hole to centreline of pocket.
- (IV) Other material available.

Ao	4.75	+/- 0.05
Bo	5.25	+/- 0.05
Ko	2.20	+/- 0.05
F	5.50	+/- 0.05
P1	8.00	+/- 0.10
W	12.00	+0.30 / -0.10

Assembly Notes

Compatible with lead-free soldering processes with 260°C peak reflow temperature.

This package is air-cavity and non-hermetic, and therefore cannot be subjected to aqueous washing. The use of no-clean solder to avoid washing after soldering is highly recommended.

Contact plating: Ni-Au

Solder rework not recommended

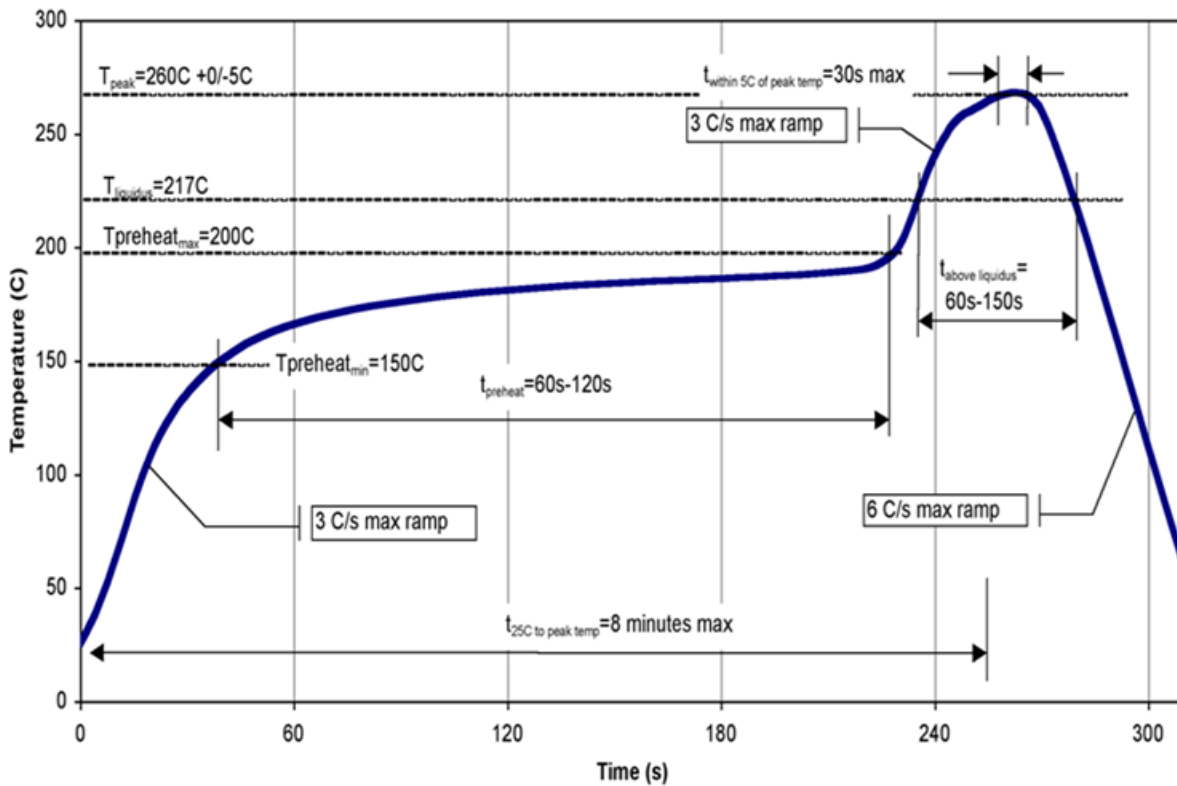

Recommended Soldering Temperature Profile

Handling Precautions

Parameter	Rating	Standard
ESD – Human Body Model (HBM)	1A	ANSI/ESDA/JEDEC JS-001
ESD – Charged Device Model (CDM)	C3	ANSI/ESDA/JEDEC JS-002
MSL – Convection Reflow 260 °C	3	JEDEC standard IPC/JEDEC J-STD-020



Caution!
ESD-Sensitive Device

RoHS Compliance

This product is compliant with the 2011/65/EU RoHS directive (Restrictions on the Use of Certain Hazardous Substances in Electrical and Electronic Equipment), as amended by Directive 2015/863/EU. This product also has the following attributes:

- Lead Free
- Antimony Free
- TBBP-A (C₁₅H₁₂Br₄O₂) Free

Contact Information

For the latest specifications, additional product information, worldwide sales and distribution locations:

Tel: 1-844-890-8163

Web: www.qorvo.com

Email: customer.support@qorvo.com

Important Notice

The information contained herein is believed to be reliable; however, Qorvo makes no warranties regarding the information contained herein and assumes no responsibility or liability whatsoever for the use of the information contained herein. All information contained herein is subject to change without notice. Customers should obtain and verify the latest relevant information before placing orders for Qorvo products. The information contained herein or any use of such information does not grant, explicitly or implicitly, to any party any patent rights, licenses, or any other intellectual property rights, whether with regard to such information itself or anything described by such information. **THIS INFORMATION DOES NOT CONSTITUTE A WARRANTY WITH RESPECT TO THE PRODUCTS DESCRIBED HEREIN, AND QORVO HEREBY DISCLAIMS ANY AND ALL WARRANTIES WITH RESPECT TO SUCH PRODUCTS WHETHER EXPRESS OR IMPLIED BY LAW, COURSE OF DEALING, COURSE OF PERFORMANCE, USAGE OF TRADE OR OTHERWISE, INCLUDING THE IMPLIED WARRANTIES OF MERCHANTABILITY AND FITNESS FOR A PARTICULAR PURPOSE.**

Without limiting the generality of the foregoing, Qorvo products are not warranted or authorized for use as critical components in medical, life-saving, or life-sustaining applications, or other applications where a failure would reasonably be expected to cause severe personal injury or death.

Copyright 2021 © Qorvo, Inc. | Qorvo is a registered trademark of Qorvo, Inc.

X-ON Electronics

Largest Supplier of Electrical and Electronic Components

Click to view similar products for [RF Amplifier](#) category:

Click to view products by [Qorvo](#) manufacturer:

Other Similar products are found below :

[A82-1](#) [BGA622H6820XTSA1](#) [BGA 728L7 E6327](#) [BGB719N7ESDE6327XTMA1](#) [HMC397-SX](#) [HMC405](#) [HMC561-SX](#) [HMC8120-SX](#)
[HMC8121-SX](#) [HMC-ALH382-SX](#) [HMC-ALH476-SX](#) [SE2433T-R](#) [SMA3101-TL-E](#) [SMA39](#) [A66-1](#) [A66-3](#) [A67-1](#) [LX5535LQ](#) [LX5540LL](#)
[MAAM02350](#) [HMC3653LP3BETR](#) [HMC549MS8GETR](#) [HMC-ALH435-SX](#) [SMA101](#) [SMA32](#) [SMA411](#) [SMA531](#) [SST12LP17E-XX8E](#)
[SST12LP19E-QX6E](#) [WPM0510A](#) [HMC5929LS6TR](#) [HMC5879LS7TR](#) [HMC1126](#) [HMC1087F10](#) [HMC1086](#) [HMC1016](#) [SMA1212](#)
[MAX2689EWS+T](#) [MAAMSS0041TR](#) [MAAM37000-A1G](#) [LTC6430AIUF-15#PBF](#) [CHA5115-QDG](#) [SMA70-2](#) [SMA4011](#) [A231](#) [HMC-](#)
[AUH232](#) [LX5511LQ](#) [LX5511LQ-TR](#) [HMC7441-SX](#) [HMC-ALH310](#)