



QPA1022

8.5 – 11 GHz 4 W GaN Power Amplifier

Product Overview

Qorvo's QPA1022 is a packaged, high performance power amplifier fabricated on Qorvo's production 0.15 um GaN on SiC process (QGaN15). Covering 8.5–11.0 GHz, the QPA1022 provides > 4 W of saturated output power and 24.5 dB of large-signal gain while achieving 45% power-added efficiency.

Packaged in a small 4 x 4 mm plastic overmold QFN, the QPA1022 is matched to 50Ω with integrated DC blocking capacitors at RF output and DC grounded input port. It also has a built-in power detector for system RF power checking. With a compact dimension, it can support tight lattice spacing requirements for phased array radar applications. It is also an ideal component to support test instrumentation and commercial communication systems.

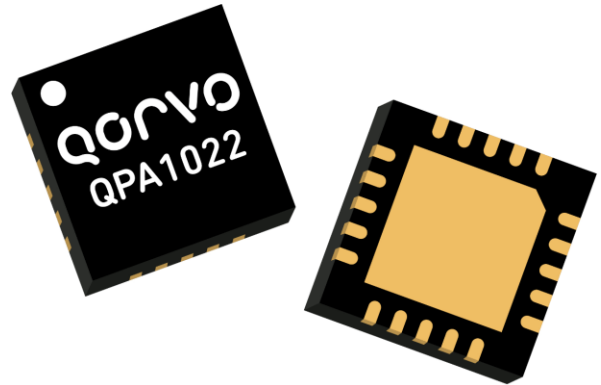

Key Features

- Frequency Range: 8.5 – 11 GHz
- P_{SAT} ($P_{IN}=12$ dBm): 36.5 dBm
- PAE ($P_{IN}=12$ dBm): 45 %
- Power Gain ($P_{IN}= 12$ dBm): 24.5 dB
- Small Signal Gain: 32 dB
- Bias: $V_D = 22$ V, $I_{DQ} = 180$ mA
- Package Dimensions: 4 x 4 x 0.85 mm

Performance is typical across frequency. Please reference electrical specification table and data plots for more details.

Functional Block Diagram

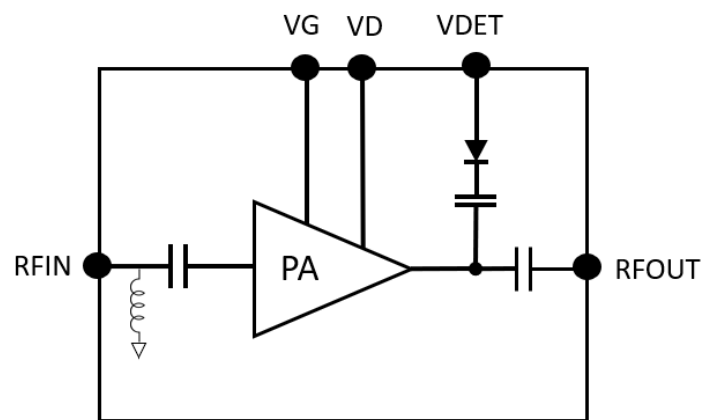

Applications

- Radar
- Electronic Warfare
- Communications

Ordering Information

Part No.	Description
QPA1022	QPA1022 Amplifier, Shipping Tray, Qty 50
QPA1022TR	QPA1022 Amplifier, Tape & Reel 7", Qty 250
QPA1022EVB0	QPA1022 Evaluation Board, Qty 1

Absolute Maximum Ratings

Parameter	Value / Range	Units
Drain Voltage (V_D)	28	V
Gate Voltage Range (V_G)	-5 to 0	V
Drain Current (I_D)	600	mA
Gate Current (I_G)	10	mA
Input Power (P_{IN}), 3:1 VSWR, $V_D=22$ V, $I_{DQ}=180$ mA, 85 °C	27	dBm
Storage Temperature	-55 to +150	°C

Exceeding any one or a combination of the Absolute Maximum Rating conditions may cause permanent damage to the device. Extended application of Absolute Maximum Rating conditions to the device may reduce device reliability.

Recommended Operating Conditions

Parameter	Value / Range	Units
Drain Voltage (V_D)	22	V
Drain Current (I_{DQ})	180	mA
Operating Temperature	- 40 to + 85	°C

Electrical specifications are measured at specified test conditions. Specifications are not guaranteed over all recommended operating conditions.

Electrical Specifications

Test conditions unless otherwise noted: Temp = 25 °C, $V_D = 22$ V, $I_{DQ} = 180$ mA. Data de-embedded to the reference planes.

Parameter	Min	Typ	Max	Units
Operational Frequency	8.5		11	GHz
Output Power (Pulse and CW, $P_{IN}=12$ dBm)		36.5		dBm
Power Added Efficiency (Pulse and CW, $P_{IN}= 12$ dBm)		45		%
Large Signal Gain (Pulse and CW, $P_{IN}=12$ dBm)		24.5		dB
Small Signal Gain		32		dB
Input Return Loss		20		dB
Output Return Loss		10		dB
Harmonic Suppression (CW @ $P_{OUT} = 36$ dBm, $2f_0$)		25		dBc
P_{OUT} Temp. Coeff. ($P_{IN} = 12$ dBm)		-0.01		dB/°C
Small Signal Gain Temp. Coefficient		-0.084		dB/°C

Note: For pulse power, Pulse Width = 100 μ S, Duty Cycle = 10%

Performance Plots – Small Signal

Test conditions unless otherwise noted: $V_D = 22\text{ V}$, $I_{DQ} = 180\text{ mA}$, Temperature = + 25 °C

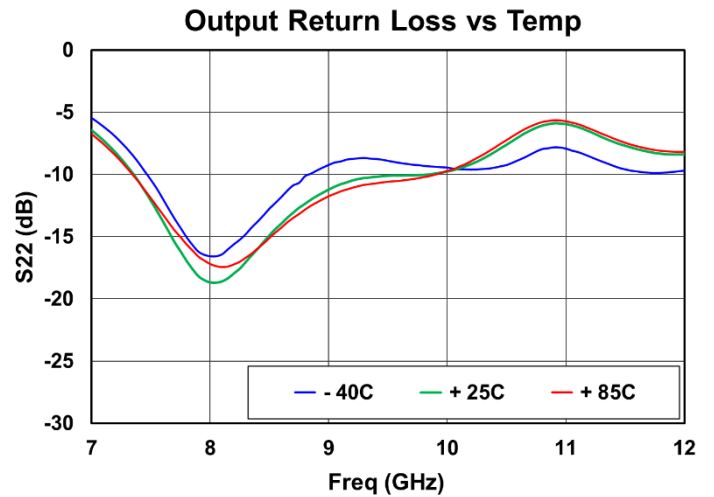
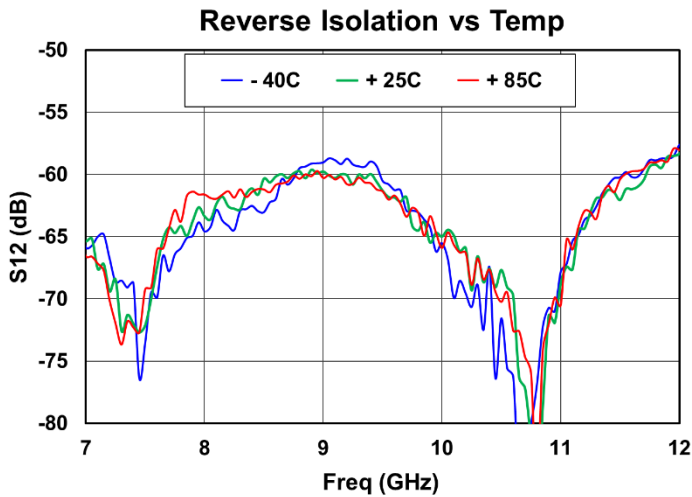
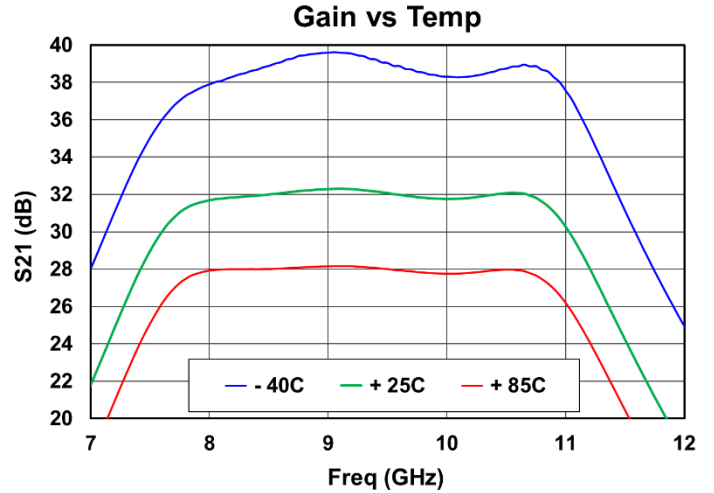
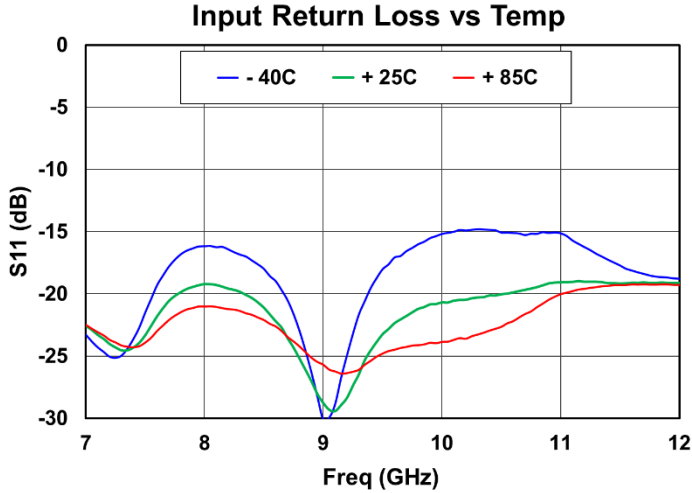

Performance Plots – Small Signal

Test conditions unless otherwise noted: $V_D = 22\text{ V}$, $I_{DQ} = 180\text{ mA}$, Temperature = + 25 °C

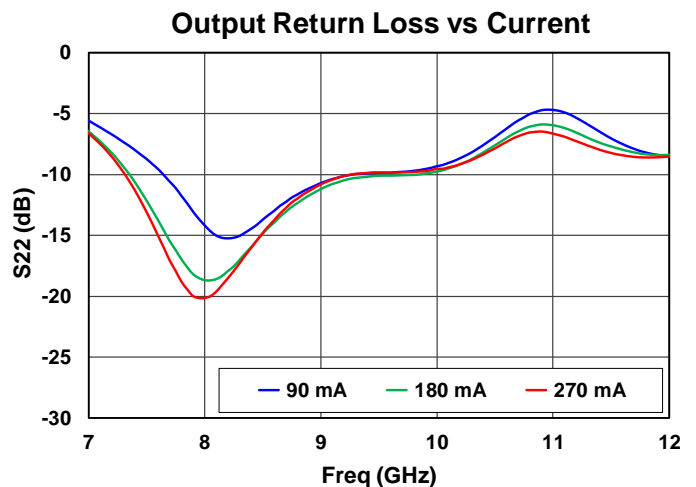
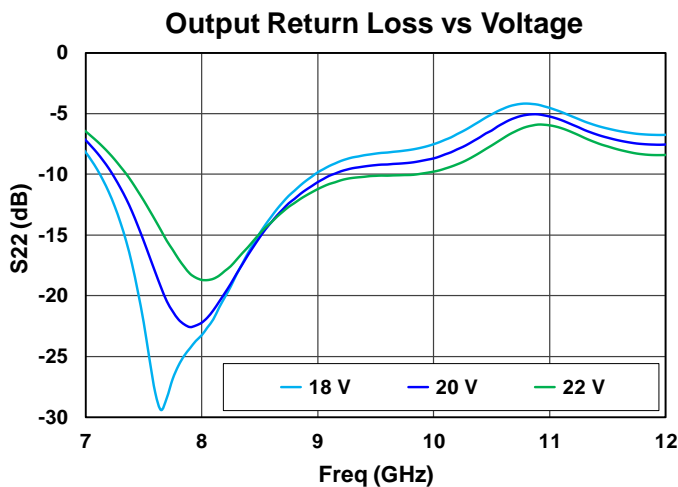
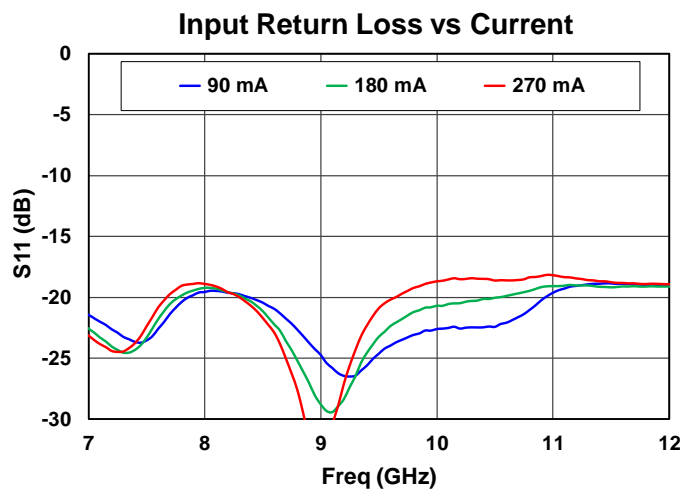
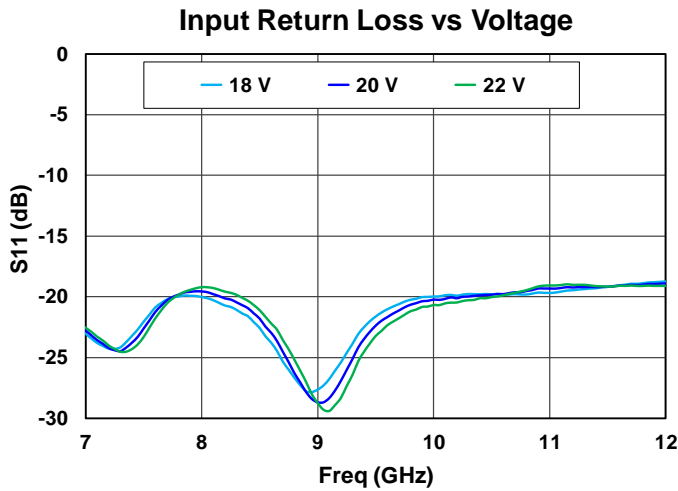
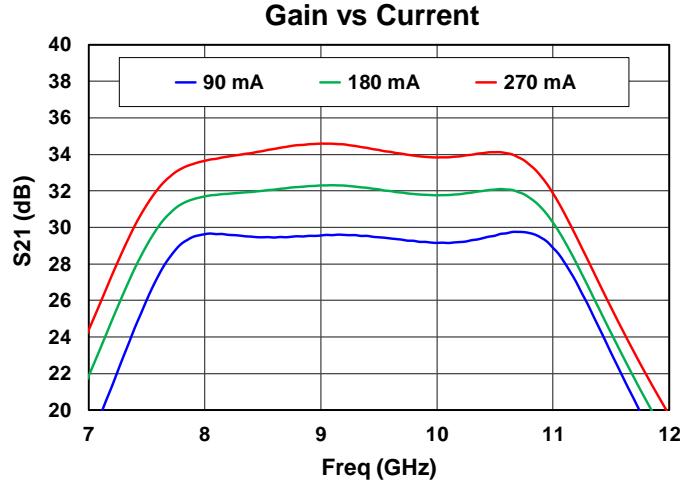
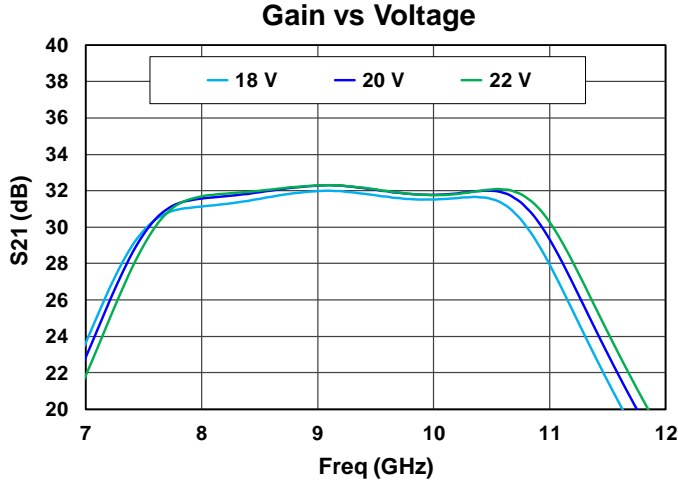

Performance Plots – Large Signal, Pulse

Test conditions unless otherwise noted: $V_D = 22\text{ V}$, $I_{BQ} = 180\text{ mA}$, $P_{in} = 12\text{ dBm}$, Pulse Width = 100 μs , DC = 10%, Temp = + 25 °C

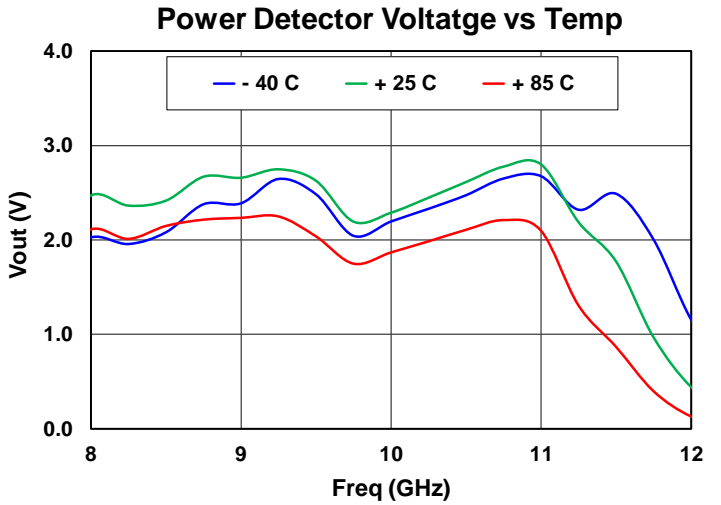
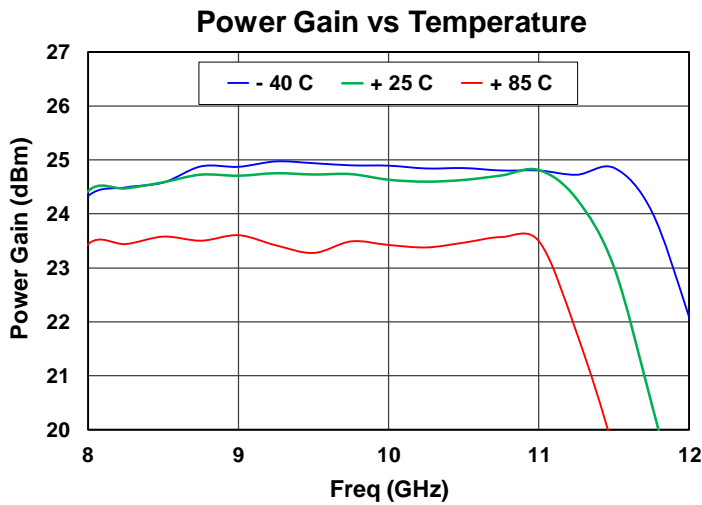
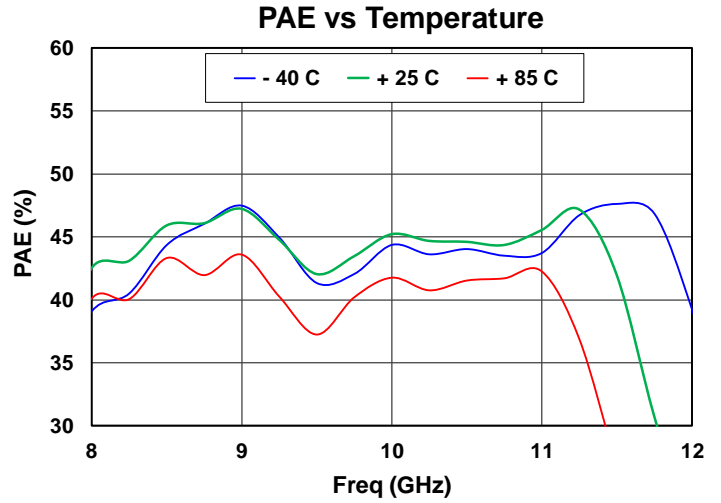
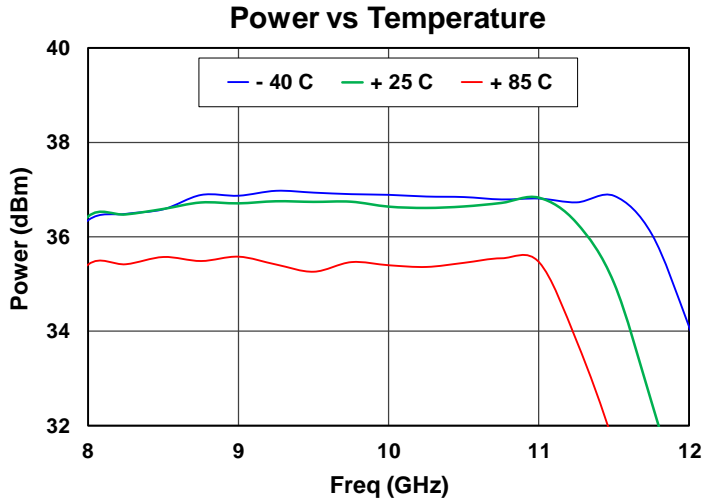

Performance Plots – Large Signal, Pulse

Test conditions unless otherwise noted: $V_D = 22\text{ V}$, $I_{DQ} = 180\text{ mA}$, $P_{in} = 12\text{ dBm}$, Pulse Width = 100 μs , DC = 10%, Temp = + 25 °C

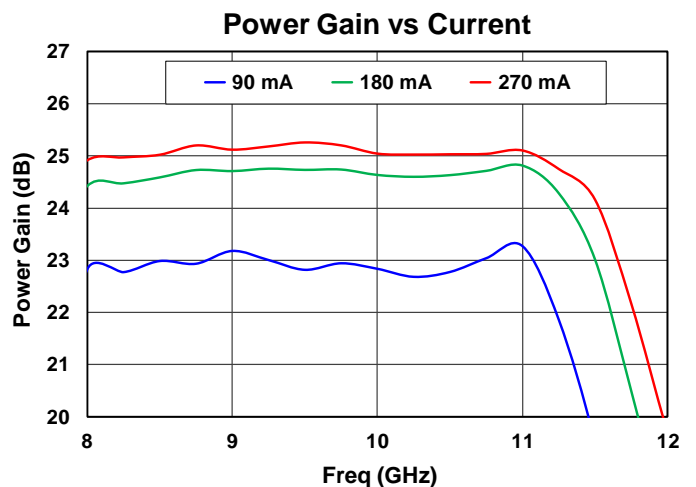
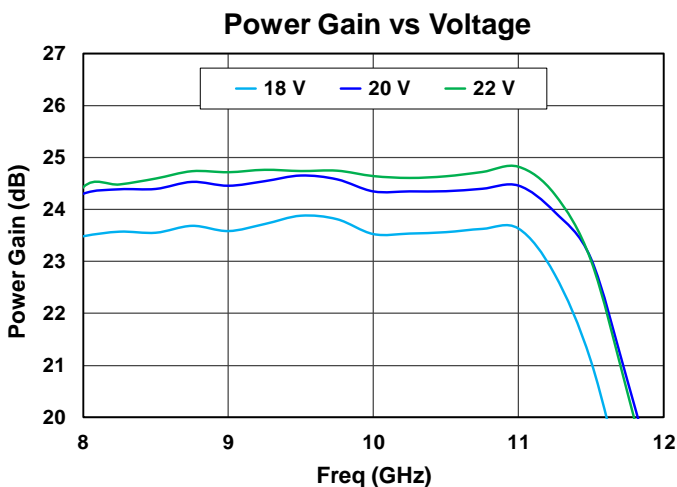
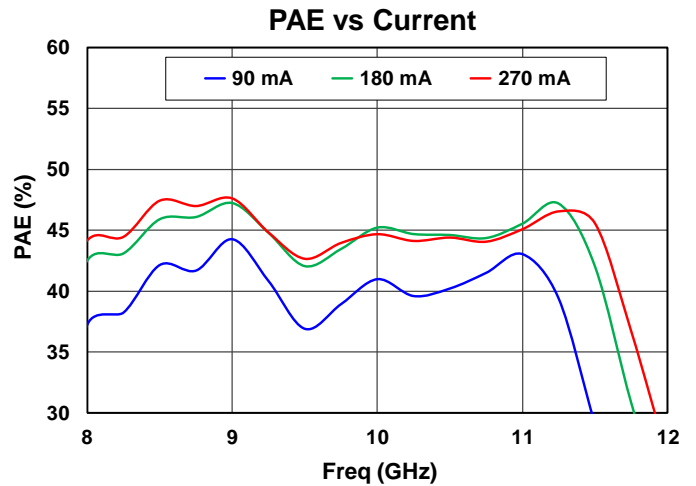
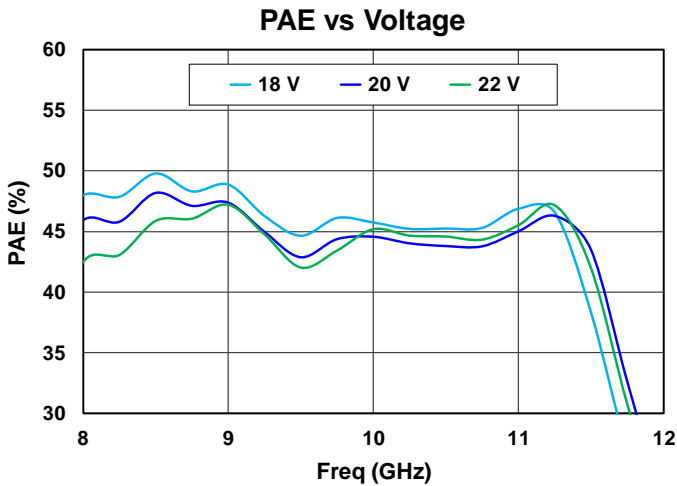
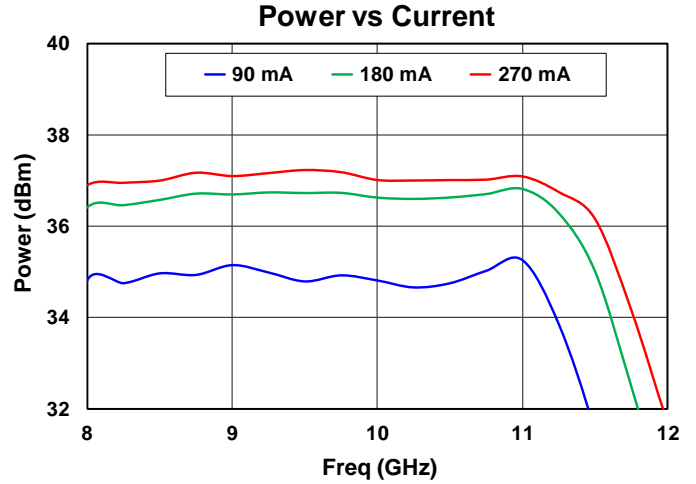
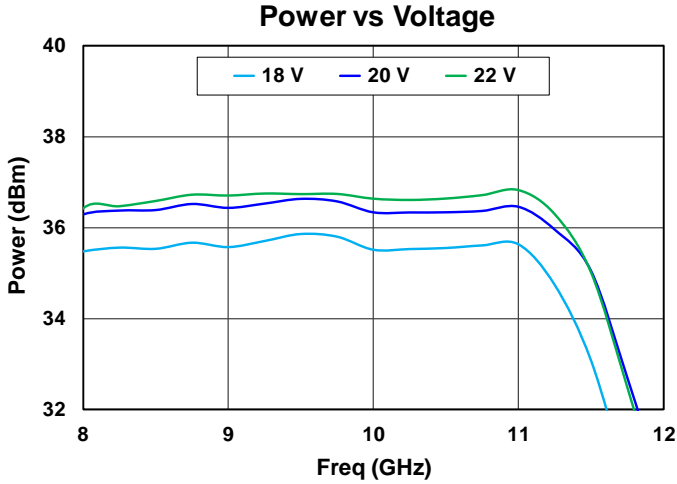

Performance Plots – Large Signal, Pulse

Test conditions unless otherwise noted: $V_D = 22\text{ V}$, $I_{DQ} = 180\text{ mA}$, Pulse Width = 100 μS , DC = 10%, Temp = + 25 °C

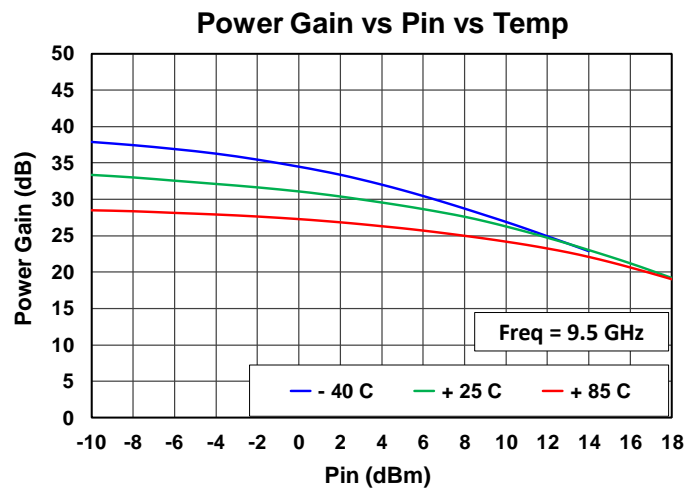
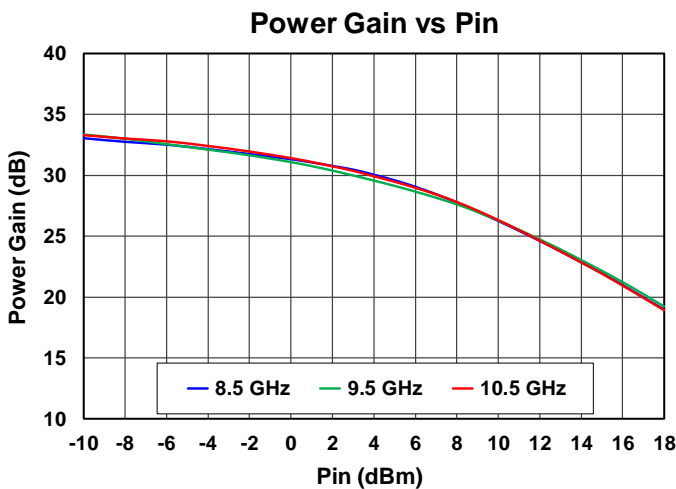
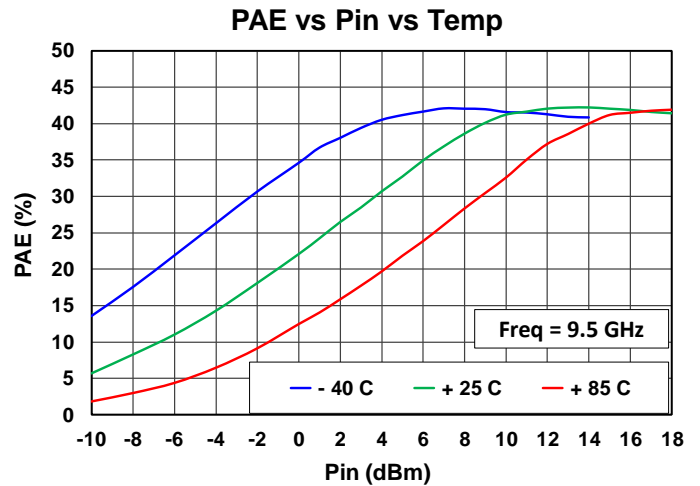
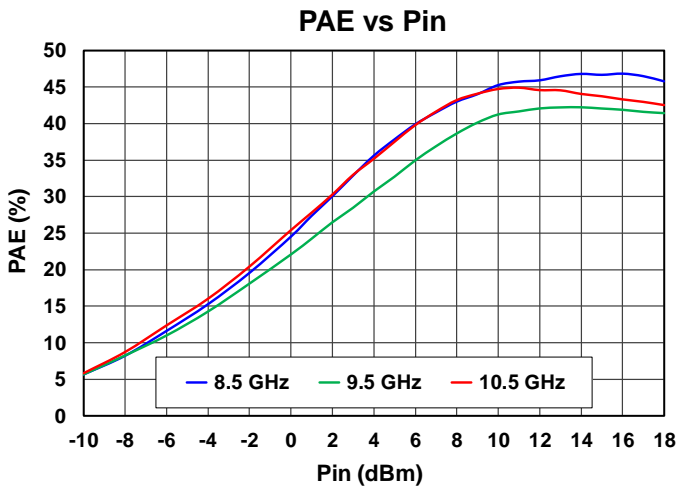
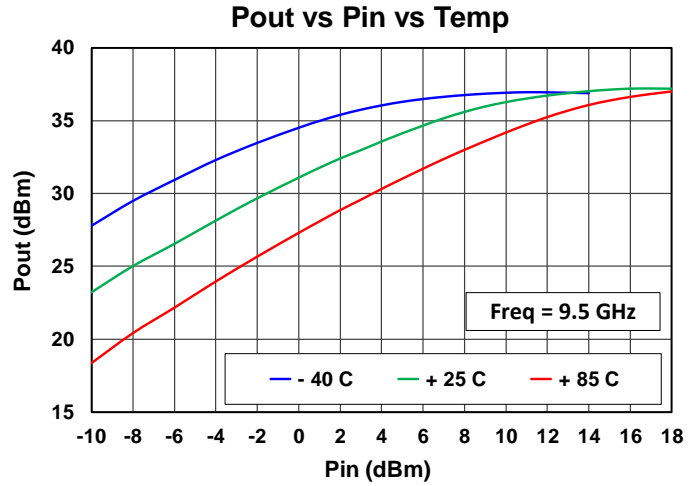
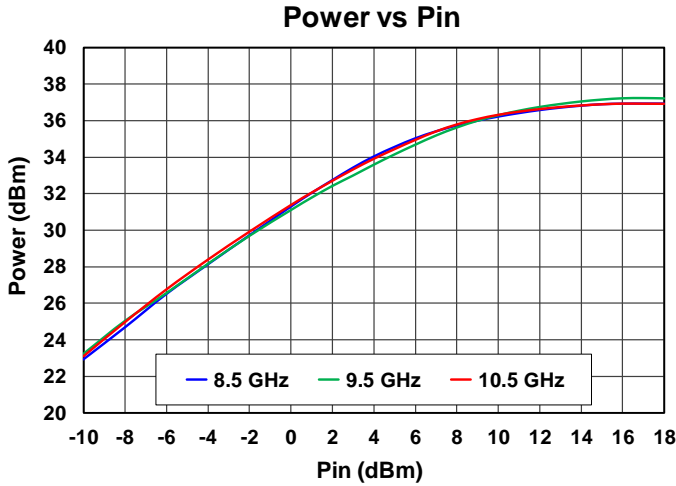

Performance Plots – Large Signal, Pulse

Test conditions unless otherwise noted: $V_D = 22\text{ V}$, $I_{DQ} = 180\text{ mA}$, Pulse Width = 100 μS , DC = 10%, Temp = + 25 °C

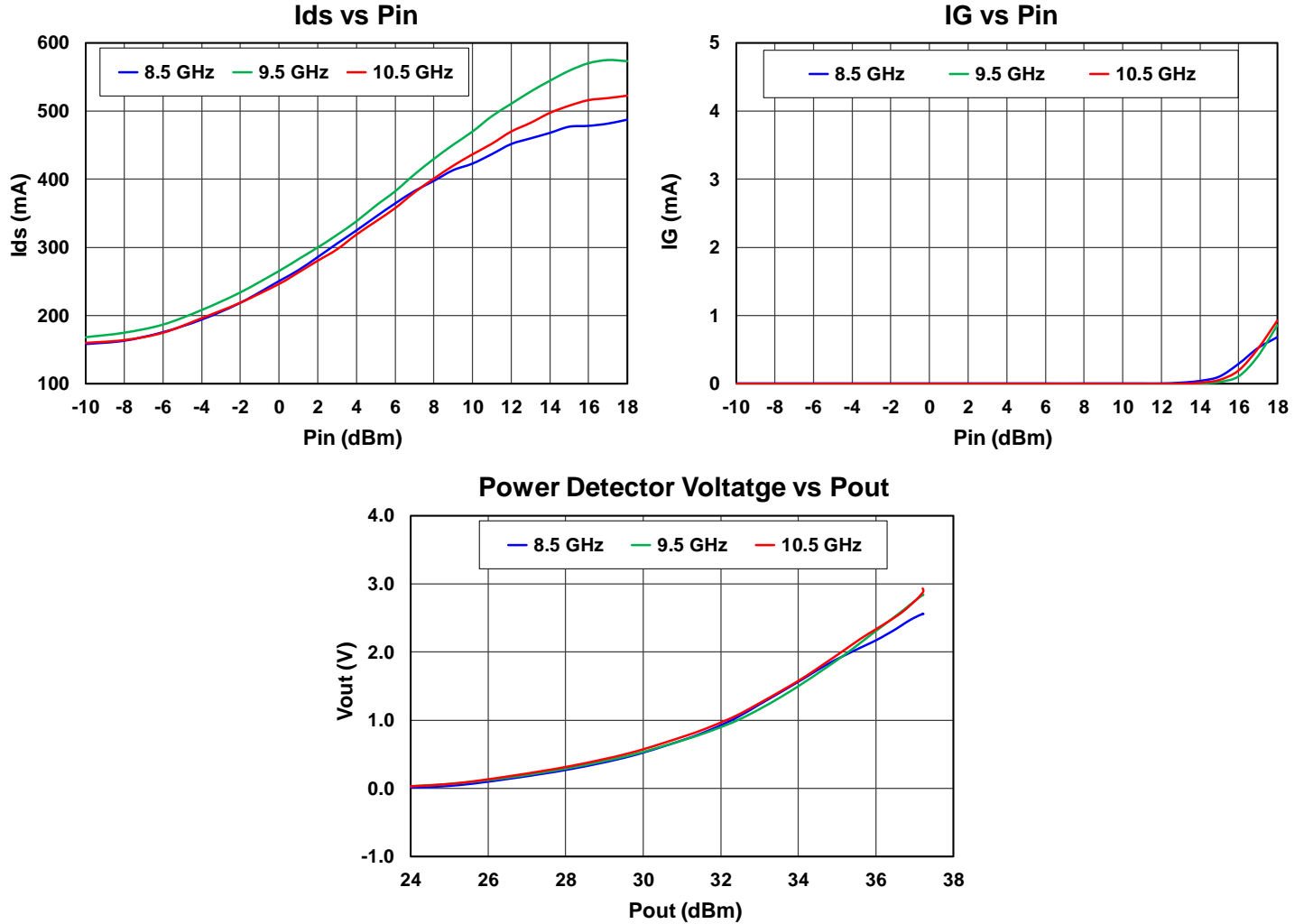

Performance Plots – Large Signal, CW

Test conditions unless otherwise noted: $V_D = 22\text{ V}$, $I_{DQ} = 180\text{ mA}$, $P_{in} = 12\text{ dBm}$, Temperature = + 25 °C

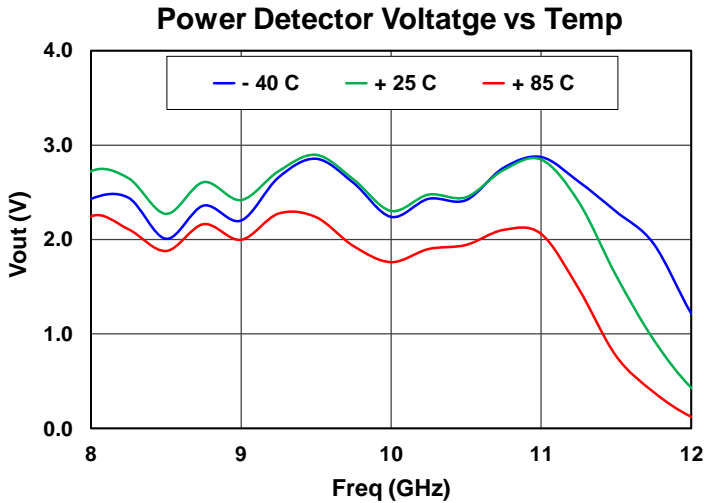
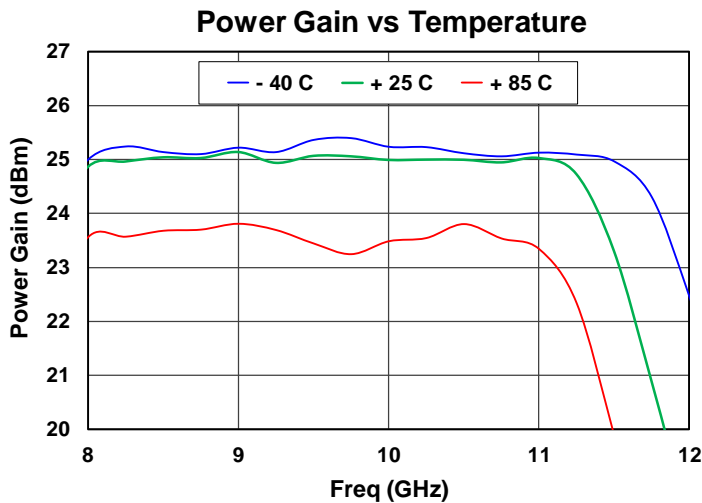
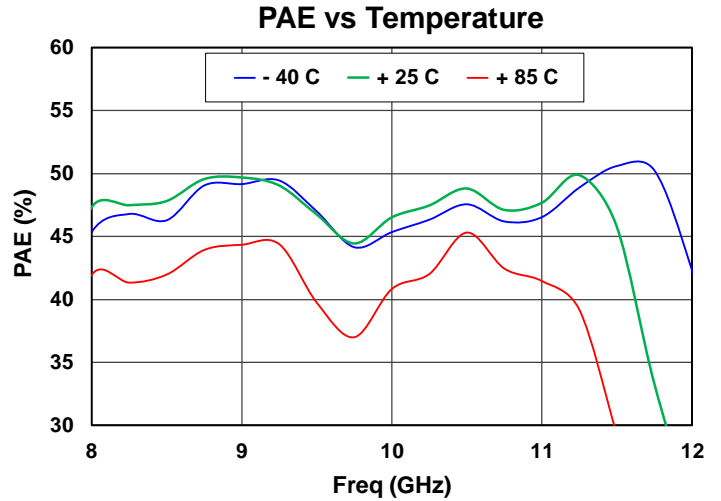
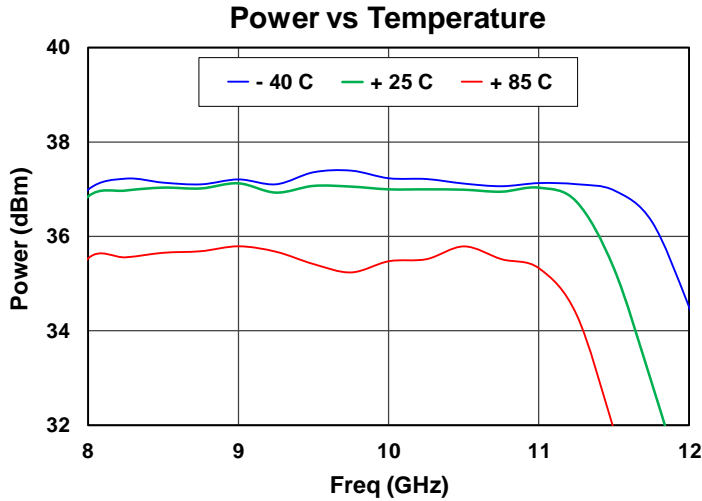

Performance Plots – Large Signal, CW

Test conditions otherwise noted: $V_D = 22\text{ V}$, $I_{DQ} = 180\text{ mA}$, Temperature = + 25 °C

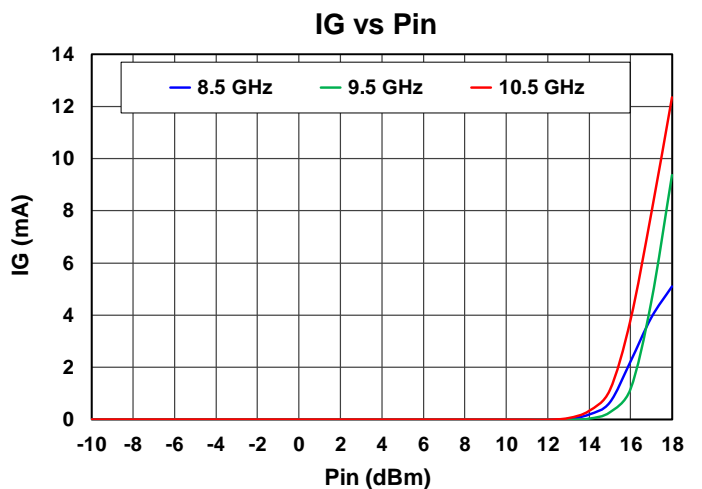
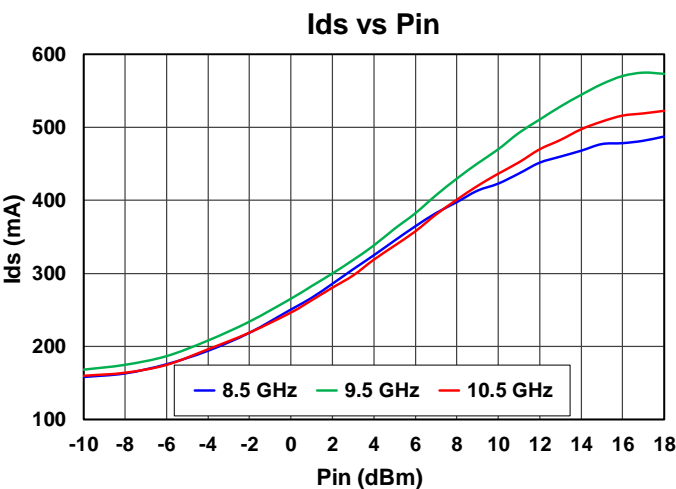
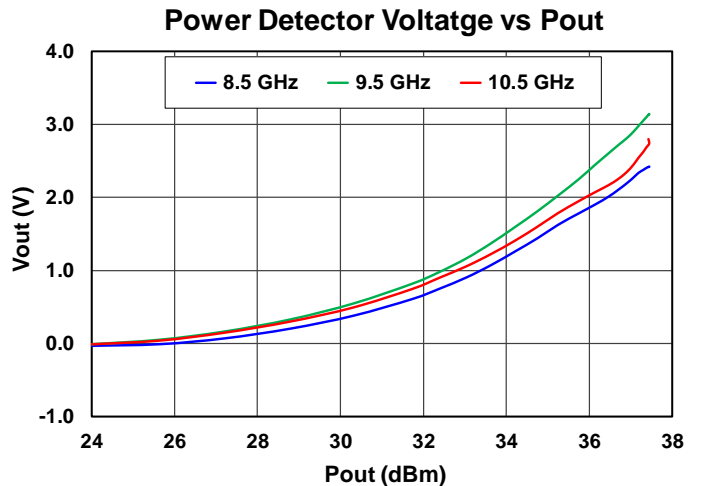
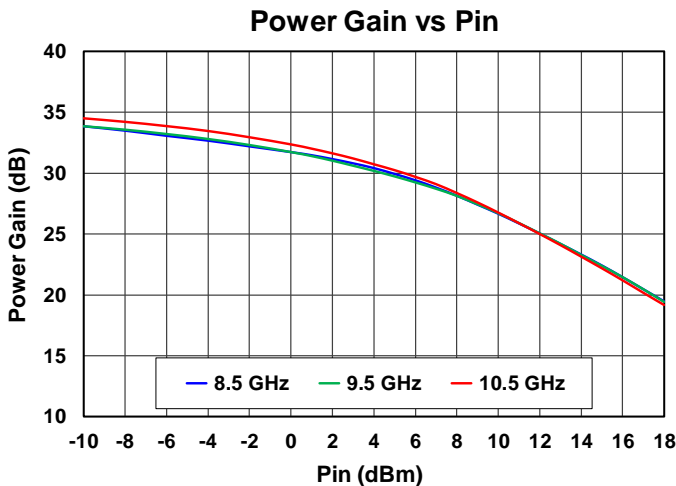
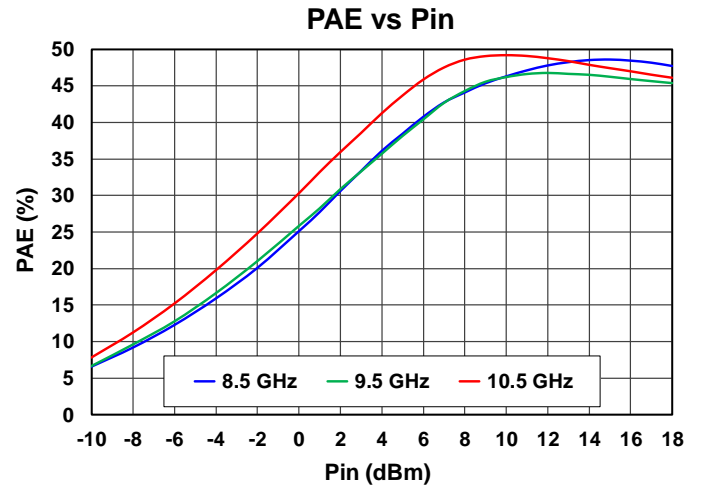
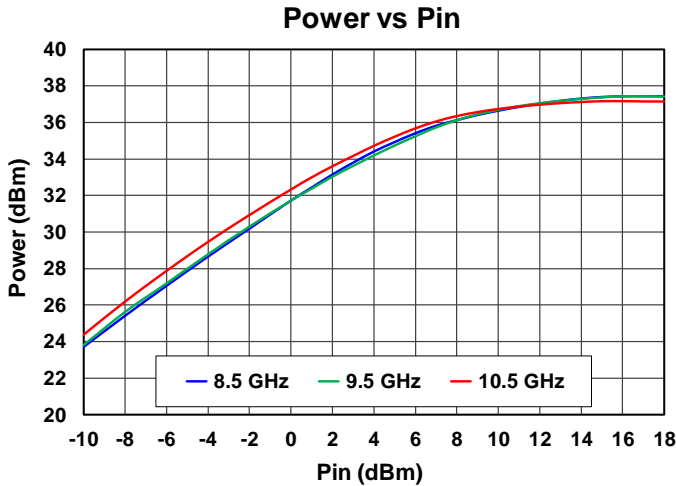

Performance Plots – HarmonicSuppressions, CW

Test conditions otherwise noted: $V_D = 22\text{ V}$, $I_{DQ} = 180\text{ mA}$, Temperature = + 25 °C

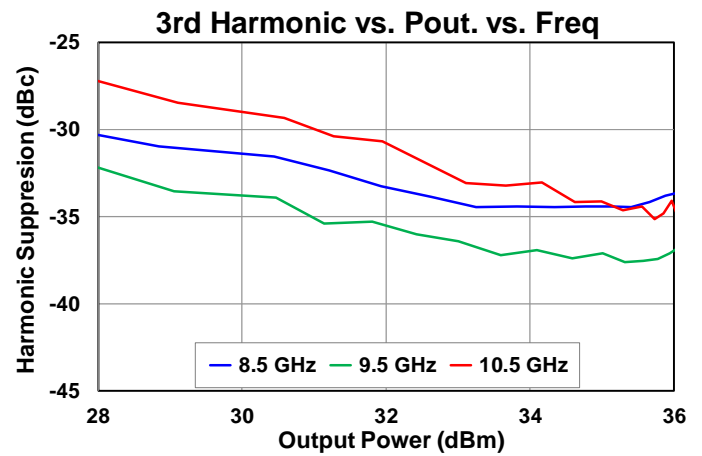
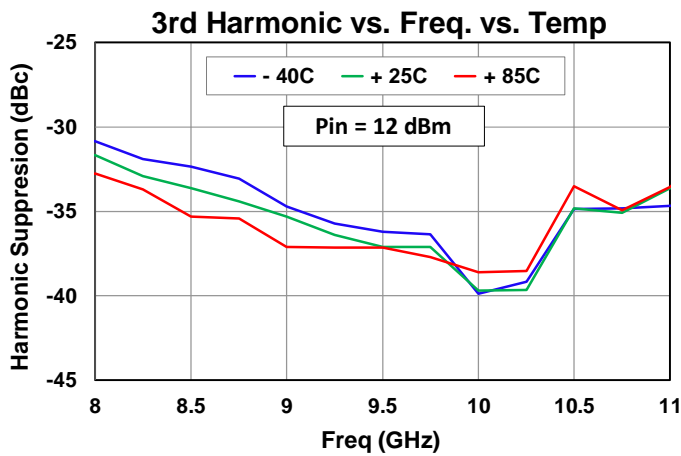
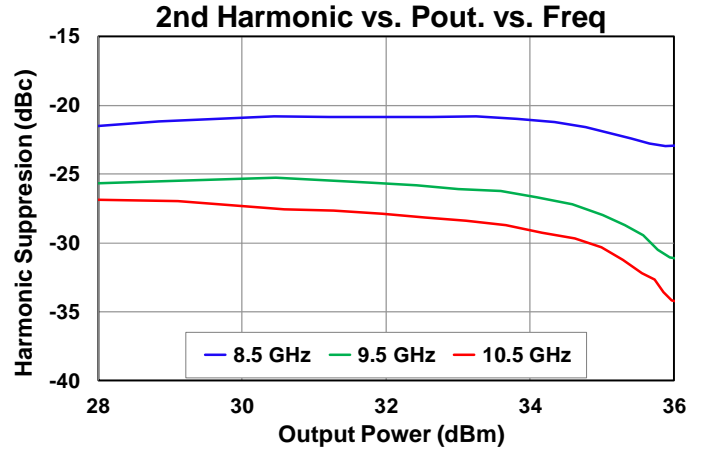
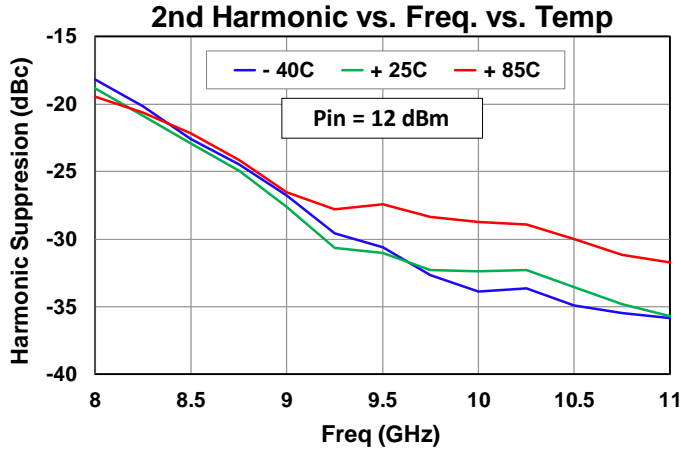

Thermal and Reliability Information

Parameter	Test Conditions	Value	Units
Thermal Resistance (θ_{JC}) ⁽¹⁾	$T_{base} = 85\text{ }^\circ\text{C}$, $V_D = 22\text{ V}$, $I_{DQ} = 180\text{ mA}$, $P_{DISS} = 3.96\text{ W}$, CW, No RF (quiescent DC operation)	10.9	$^\circ\text{C/W}$
Channel Temperature, T_{CH} (No RF) ⁽²⁾		128.2	$^\circ\text{C}$
Thermal Resistance (θ_{JC}) ⁽¹⁾	$T_{base} = 85\text{ }^\circ\text{C}$, $V_D = 22\text{ V}$, $I_{DQ} = 180\text{ mA}$, CW Freq = 9.5 GHz, $I_{D_Drive} = 0.514\text{ A}$, $P_{IN} = 18\text{ dBm}$, $P_{OUT} = 37.0\text{ dBm}$, $P_{DISS} = 6.4\text{ W}$	8.5	$^\circ\text{C/W}$
Channel Temperature, T_{CH} (Under RF) ⁽²⁾		139.4	$^\circ\text{C}$

Notes:

- Thermal resistance is referenced to the back of Cu-Mo carrier plate, assuming carrier thickness 20 mils, eutectic die attachment, back side of carrier temperature at 85 $^\circ\text{C}$
- Refer to the following document: [GaN Device Channel Temperature, Thermal Resistance, and Reliability Estimates](#)

Dissipated Power under RF Drive

Test conditions otherwise noted: $V_D = 22\text{ V}$, $I_{DQ} = 180\text{ mA}$, CW, Temperature = +85 $^\circ\text{C}$

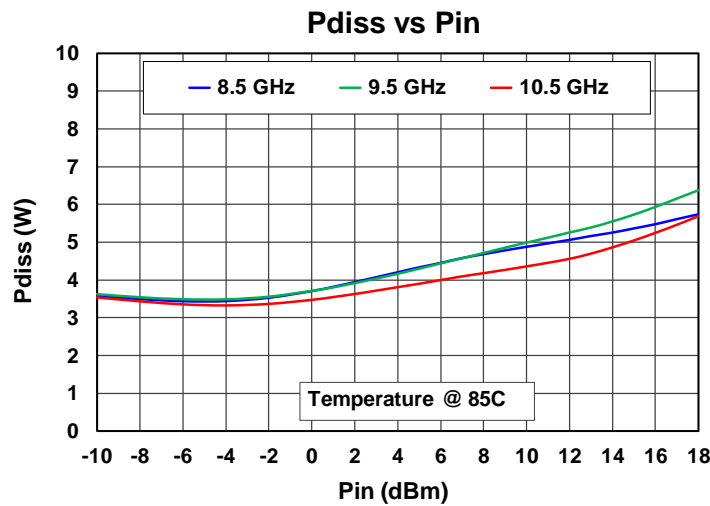

Mechanical Drawing & Pad Description

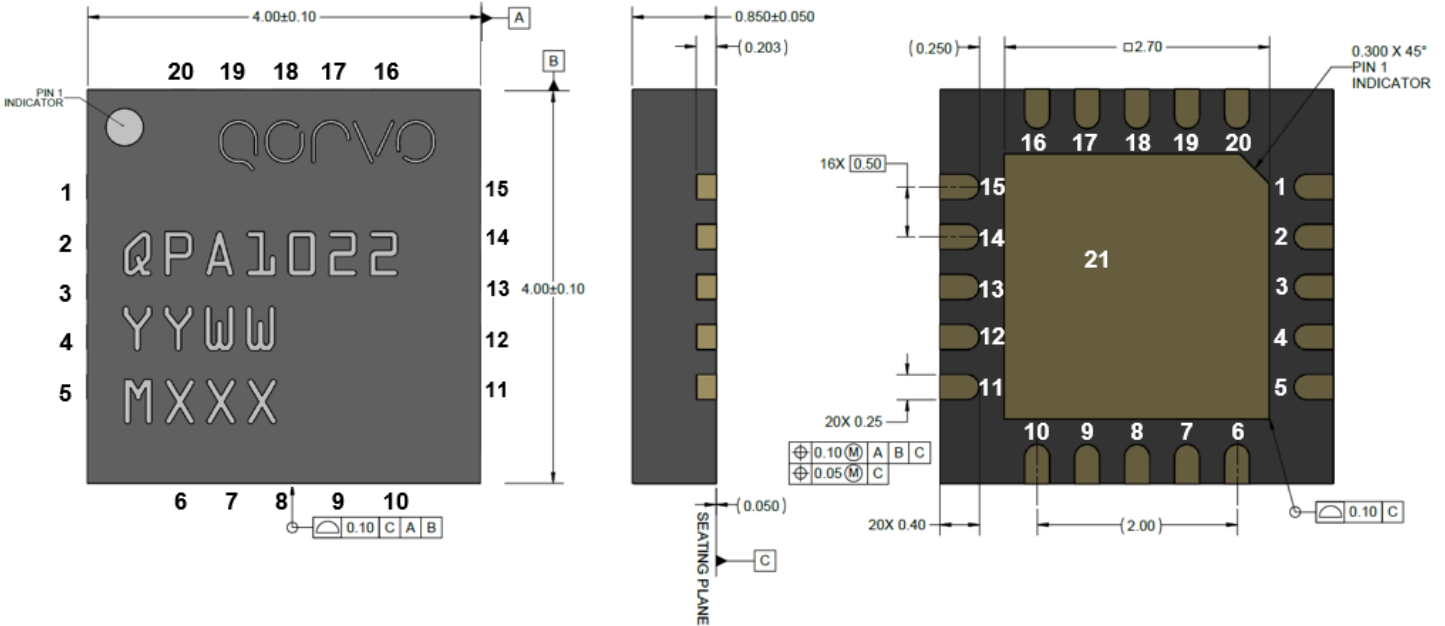

Dimensions in mm, package is mold encapsulated with NiPdAu plated leads

Part Marking: QPA1022: Part Number, YY = Part Assembly Year, WW = Part Assembly Week, MXXX = Batch ID

Pin Number	Label	Description
1, 2, 4-12, 14, 15, 18, 20	N/C	No internal connection. Recommend to GND at the PCB level
3	RF Input	Matched to 50 ohms, DC Grounded
13	RF Output	Matched to 50 ohms, DC blocked
16	VDET	Power detection, bias not required
17	VD	Drain voltage. Bypass network required.
19	VG	Gate voltage. Bypass network required.
21 (slug)	GND	GROUND

Applications Information

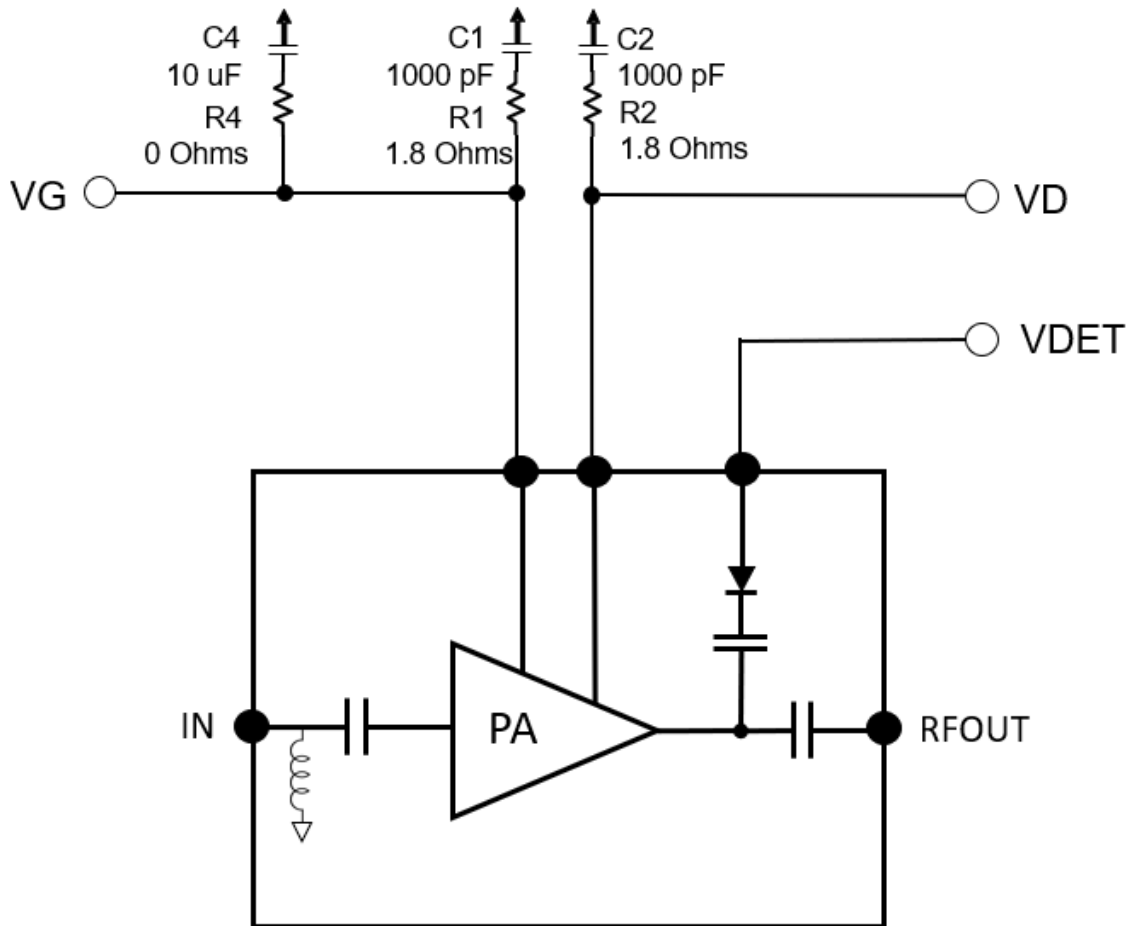

Bias-Up Procedure

1. Set I_D limit to 600 mA, I_G limit to 10 mA
2. Set V_G to -4.0 V
3. Set V_D +22 V
4. Adjust V_G more positive until $I_{DQ} \approx 180$ mA
5. Apply RF signal

Bias-Down Procedure

1. Turn off RF signal
2. Reduce V_G to -4.0 V. Ensure $I_{DQ} \sim 0$ mA
4. Set V_D to 0 V
5. Turn off V_D supply
6. Turn off V_G supply

Evaluation Board (EVB) Layout Assembly

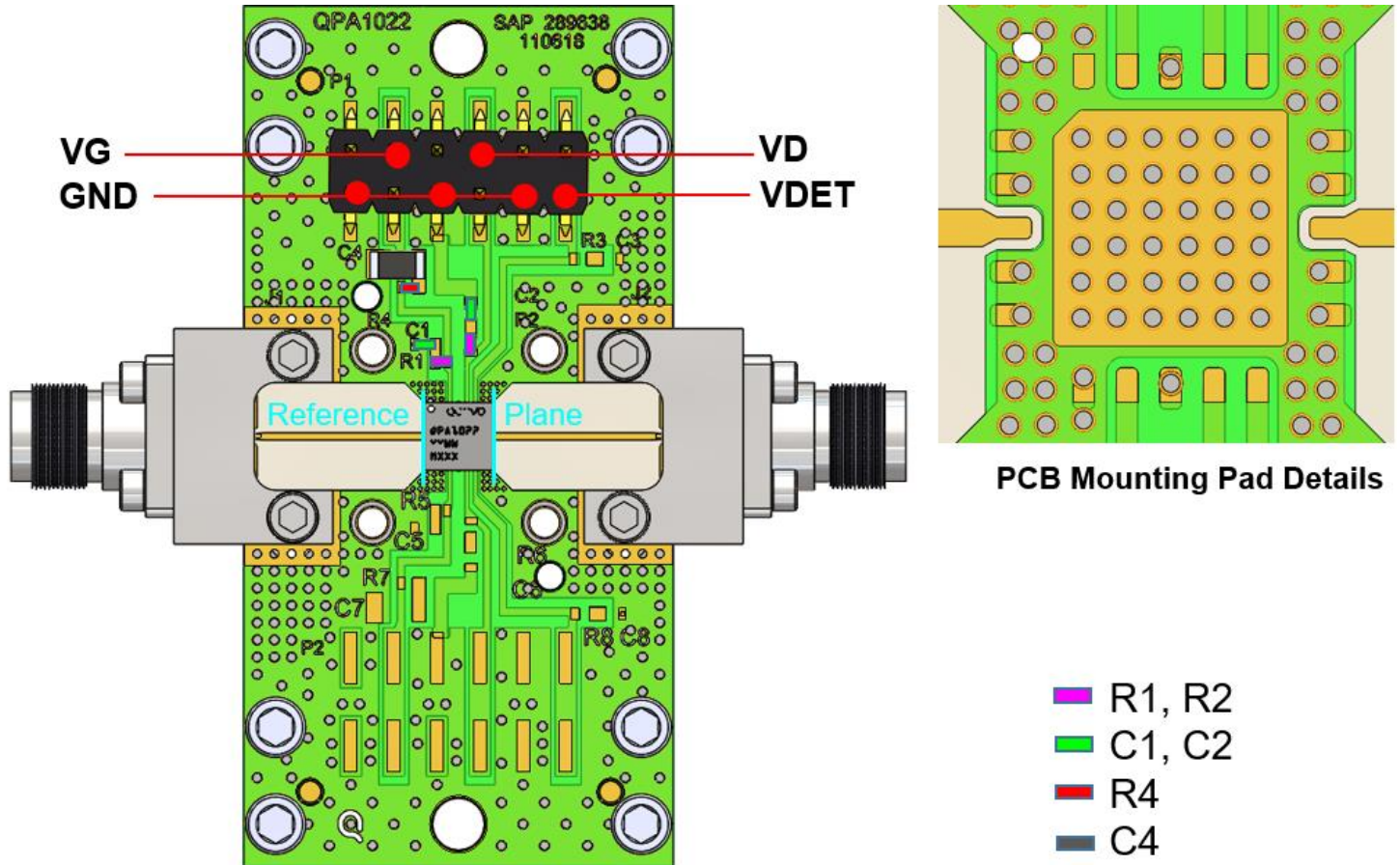

PCB is made from Rogers 4003C dielectric, 8 mil thickness, 0.5 oz. copper both sides.

Bill of Materials

Reference Des.	Value	Description	Manuf.	Part Number
C1, C2	1000 pF	CAP, 1000 pF, 20%, 50 V, 0402	Various	
R1, R2	1.8 Ohm	RES, 1.8 Ohm, 5%, 1/10 W, 0402	Various	
C4	10 uF	CAP, 10 uF, 20%, 50 V, 1206	Various	
R4	0 Ω	RES, 0 OHM, JMPR, 0402	Various	
J1, J2	2.92 mm	CONNECTOR, FEMALE, ENDLAUNCH	Southwest Microwave	1092-01A-5

Solderability

1. Compatible with the latest version of J-STD-020, Lead-free solder, 260 °C peak reflow temperature.

Recommended Soldering Temperature Profile

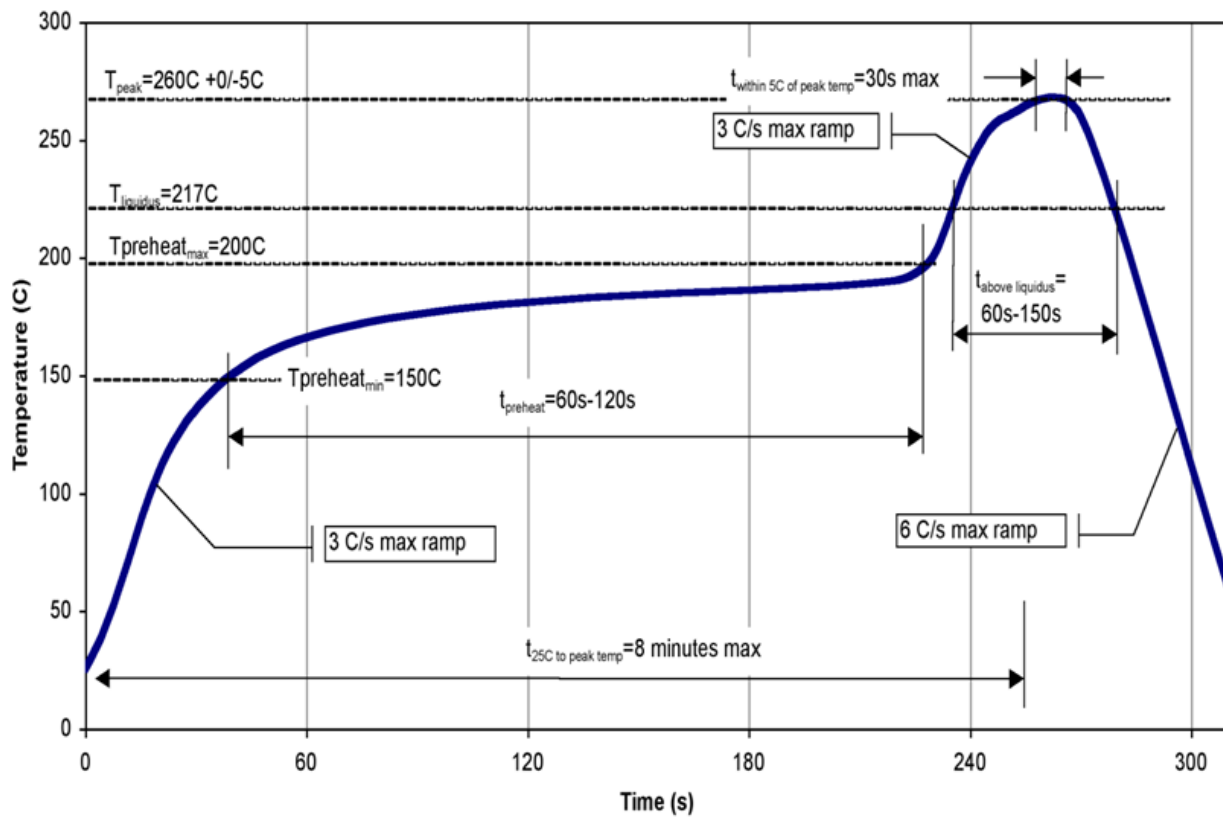

Handling Precautions

Parameter	Rating	Standard
ESD – Human Body Model (HBM)	1B	ESDA / JEDEC JS-001-2012
ESD – Charged Device Model (CDM)	C3	ESDA / JEDEC JS-002-2014
MSL – Convection Reflow 260 °C	3	JEDEC standard IPC/JEDEC J-STD-020



Caution!

ESD-Sensitive Device

RoHS Compliance

This part is compliant with 2011/65/EU RoHS directive (Restrictions on the Use of Certain Hazardous Substances in Electrical and Electronic Equipment) as amended by Directive 2015/863/EU.

This product also has the following attributes:

- Lead Free
- Halogen Free (Chlorine, Bromine)
- Antimony Free
- TBBP-A (C₁₅H₁₂Br₄O₂) Free
- SVHC Free

Contact Information

For the latest specifications, additional product information, worldwide sales and distribution locations:

Web: www.qorvo.com

Tel: 1-844-890-8163

Email: customer.support@qorvo.com

Important Notice

The information contained herein is believed to be reliable; however, Qorvo makes no warranties regarding the information contained herein and assumes no responsibility or liability whatsoever for the use of the information contained herein. All information contained herein is subject to change without notice. Customers should obtain and verify the latest relevant information before placing orders for Qorvo products. The information contained herein or any use of such information does not grant, explicitly or implicitly, to any party any patent rights, licenses, or any other intellectual property rights, whether with regard to such information itself or anything described by such information. **THIS INFORMATION DOES NOT CONSTITUTE A WARRANTY WITH RESPECT TO THE PRODUCTS DESCRIBED HEREIN, AND QORVO HEREBY DISCLAIMS ANY AND ALL WARRANTIES WITH RESPECT TO SUCH PRODUCTS WHETHER EXPRESS OR IMPLIED BY LAW, COURSE OF DEALING, COURSE OF PERFORMANCE, USAGE OF TRADE OR OTHERWISE, INCLUDING THE IMPLIED WARRANTIES OF MERCHANTABILITY AND FITNESS FOR A PARTICULAR PURPOSE.**

Without limiting the generality of the foregoing, Qorvo products are not warranted or authorized for use as critical components in medical, life-saving, or life-sustaining applications, or other applications where a failure would reasonably be expected to cause severe personal injury or death.

Copyright 2020 © Qorvo, Inc. | Qorvo is a registered trademark of Qorvo, Inc.

X-ON Electronics

Largest Supplier of Electrical and Electronic Components

Click to view similar products for [RF Amplifier](#) category:

Click to view products by [Qorvo](#) manufacturer:

Other Similar products are found below :

[A82-1](#) [BGA622H6820XTSA1](#) [BGA 728L7 E6327](#) [BGB719N7ESDE6327XTMA1](#) [HMC397-SX](#) [HMC405](#) [HMC561-SX](#) [HMC8120-SX](#)
[HMC8121-SX](#) [HMC-ALH382-SX](#) [HMC-ALH476-SX](#) [SE2433T-R](#) [SMA3101-TL-E](#) [SMA39](#) [A66-1](#) [A66-3](#) [A67-1](#) [LX5535LQ](#) [LX5540LL](#)
[MAAM02350](#) [HMC3653LP3BETR](#) [HMC549MS8GETR](#) [HMC-ALH435-SX](#) [SMA101](#) [SMA32](#) [SMA411](#) [SMA531](#) [SST12LP17E-XX8E](#)
[SST12LP19E-QX6E](#) [WPM0510A](#) [HMC5929LS6TR](#) [HMC5879LS7TR](#) [HMC1126](#) [HMC1087F10](#) [HMC1086](#) [HMC1016](#) [SMA1212](#)
[MAX2689EWS+T](#) [MAAMSS0041TR](#) [MAAM37000-A1G](#) [LTC6430AIUF-15#PBF](#) [CHA5115-QDG](#) [SMA70-2](#) [SMA4011](#) [A231](#) [HMC-](#)
[AUH232](#) [LX5511LQ](#) [LX5511LQ-TR](#) [HMC7441-SX](#) [HMC-ALH310](#)