

### Product Overview

Qorvo’s QPA2213D is a wide band driver amplifier MMIC fabricated on Qorvo’s production 0.15 um GaN on SiC process (QGaN15). Covering 2.0–20.0 GHz, the QPA2213D provides > 2 W of saturated output power and 16 dB of large-signal gain while achieving > 23% power-added efficiency.

The QPA2213D MMIC dimensions are 2.75 x 2.75 x 0.10 mm. It can support a variety of operating conditions to best support system requirements. With good thermal properties, it can support a range of bias voltages.

The QPA2213D has DC blocking capacitors on both RF ports, which are matched to 50 ohms. The QPA2213D is ideal for both commercial and military wide band or narrow band systems.

Lead-free and RoHS compliant.



### Key Features

- Frequency Range: 2 – 20 GHz
- $P_{SAT}$  ( $P_{IN}=18$  dBm): 34 dBm
- PAE ( $P_{IN}=18$  dBm): 23 %
- Power Gain ( $P_{IN}=18$  dBm): 16 dB
- Small Signal Gain: 25 dB
- Noise Figure: 4.0 dB
- Bias:  $V_D = 18$  V,  $I_{DQ} = 330$  mA
- Die Dimensions: 2.75 x 2.75 x 0.10 mm

*Performance is typical across frequency. Please reference electrical specification table and data plots for more details.*

### Functional Block Diagram

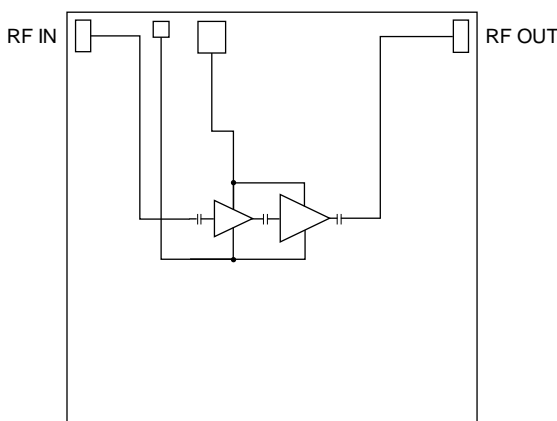

Top View

### Applications

- HPA Driver Amplifier
- Radar Systems

### Ordering Information

Part No.	Description
QPA2213D	2 –20 GHz 2 Watt GaN Amplifier (10 Pcs.)
QPA2213DS2	Samples (2 pcs.)
QPA2213DEVB01	Evaluation Board for QPA2213D

### Absolute Maximum Ratings

Parameter	Value / Range
Drain Voltage ( $V_D$ )	29.5 V
Gate Voltage Range ( $V_G$ )	-4 V to 0 V
Drain Current ( $I_D$ )	890 mA
Gate Current ( $I_G$ )	See plot pg. 23
Power Dissipation ( $P_{DISS}$ ), 85 °C	13.7 W
Input Power ( $P_{IN}$ ), 50 $\Omega$ , $V_D=18$ V, $I_{DQ}=330$ mA, 85 °C	27 dBm
Input Power ( $P_{IN}$ ), 3:1 VSWR, $V_D=18$ V, $I_{DQ}=330$ mA, 85 °C	27 dBm
Soldering Temperature	260 °C
Storage Temperature	-55 to +125 °C

Operation of this device outside the parameter ranges given above may cause permanent damage. These are stress ratings only, and functional operation of the device at these conditions is not implied.

### Recommended Operating Conditions

Parameter	Value / Range
Drain Voltage ( $V_D$ )	18 V
Drain Current ( $I_{DQ}$ )	330 mA
Operating Temperature	-40 to +85 °C

Electrical specifications are measured at specified test conditions. Specifications are not guaranteed over all recommended operating conditions.

## Electrical Specifications

Parameter		Min	Typ	Max	Units
Operational Frequency		2		20	GHz
Output Power (P <sub>IN</sub> =18 dBm)	2 GHz		34.2		dBm
	6 GHz		34.9		dBm
	10 GHz		34.5		dBm
	15 GHz		34.4		dBm
	20 GHz		33.7		dBm
Power Added Efficiency (P <sub>IN</sub> =18 dBm)	2 GHz		37.1		%
	6 GHz		24.7		%
	10 GHz		24.4		%
	15 GHz		22.7		%
	20 GHz		21.4		%
Small Signal Gain	2 GHz		25.8		dB
	6 GHz		26.4		dB
	10 GHz		25.3		dB
	15 GHz		23.4		dB
	20 GHz		21.6		dB
Input Return Loss	2 GHz		16		dB
	6 GHz		14		dB
	10 GHz		17		dB
	15 GHz		19		dB
	20 GHz		15		dB
Output Return Loss	2 GHz		7		dB
	6 GHz		18		dB
	10 GHz		20		dB
	15 GHz		18		dB
	20 GHz		15		dB
Noise Figure	2 GHz		7.6		dB
	6 GHz		4.5		dB
	10 GHz		3.2		dB
	15 GHz		4.0		dB
	20 GHz		5.3		dB
IMD3 (P <sub>OUT</sub> /Tone=27 dBm) (100 MHz tone spacing)	2 GHz		-23.6		dBc
	6 GHz		-21.9		dBc
	10 GHz		-21.9		dBc
	15 GHz		-21.8		dBc
	20 GHz		-20.3		dBc
P <sub>OUT</sub> Temp. Coeff. (85 °C to 25 °C, P <sub>IN</sub> = 18 dBm))			-0.004		dB/°C
Sm. Sig. Gain Temp. Coefficient (85 °C to -40 °C)			-0.040		dB/°C

Test conditions, unless otherwise noted: T = 25 °C, V<sub>D</sub> = 18 V, I<sub>DQ</sub> = 330 mA

Performance Plots – Small Signal

Test conditions, unless otherwise noted:  $V_D = 18\text{ V}$ ,  $I_{DQ} = 330\text{ mA}$ ,  $T = +25\text{ }^\circ\text{C}$

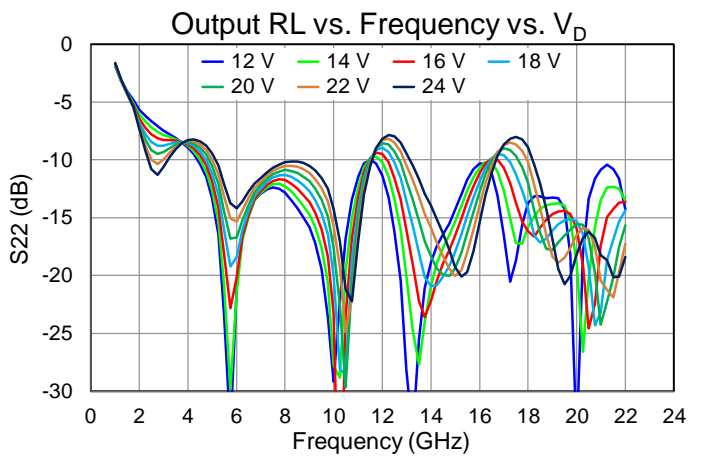
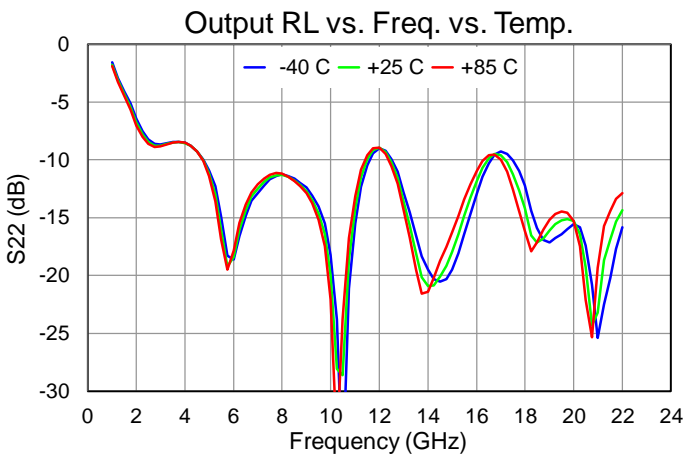
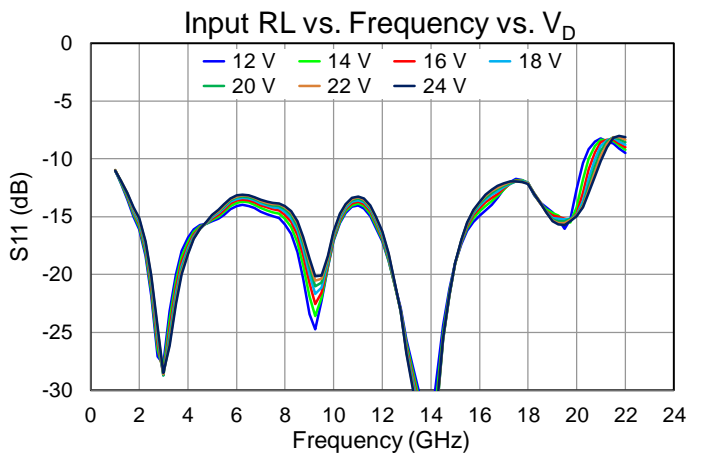
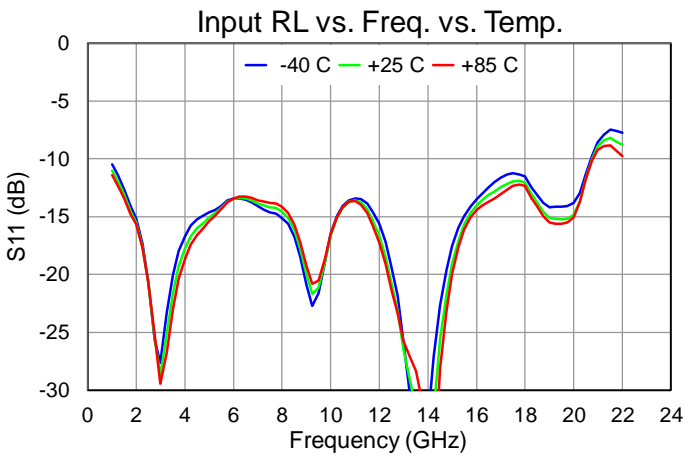
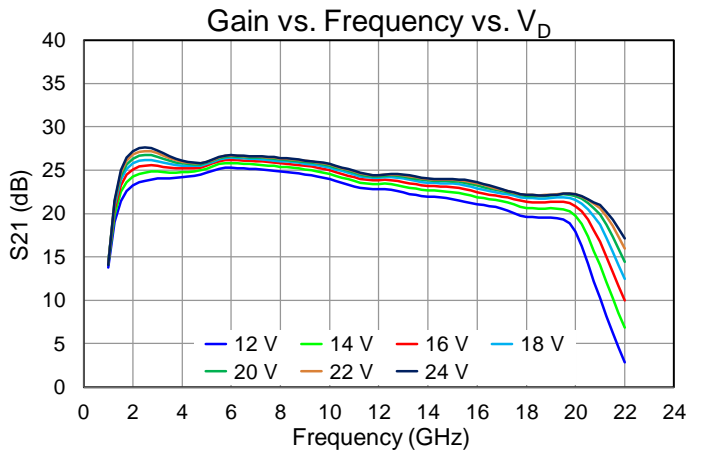
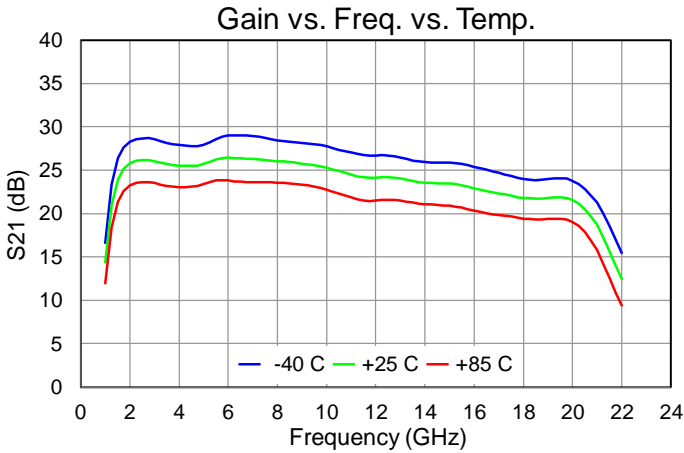

**Performance Plots – Small Signal**

Test conditions, unless otherwise noted:  $V_D = 18\text{ V}$ ,  $I_{DQ} = 330\text{ mA}$ ,  $T = +25\text{ }^\circ\text{C}$

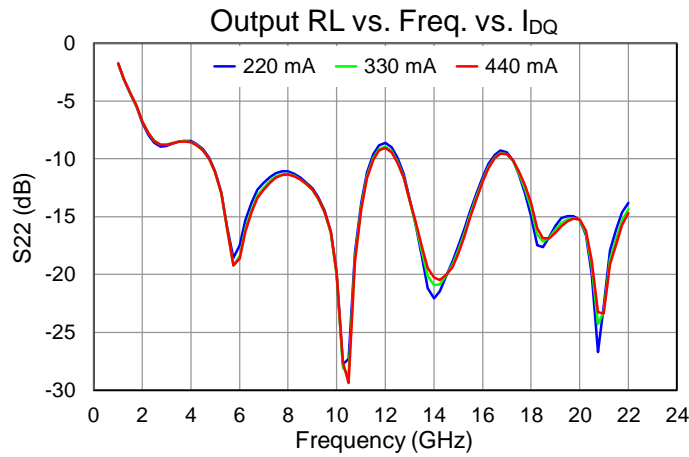
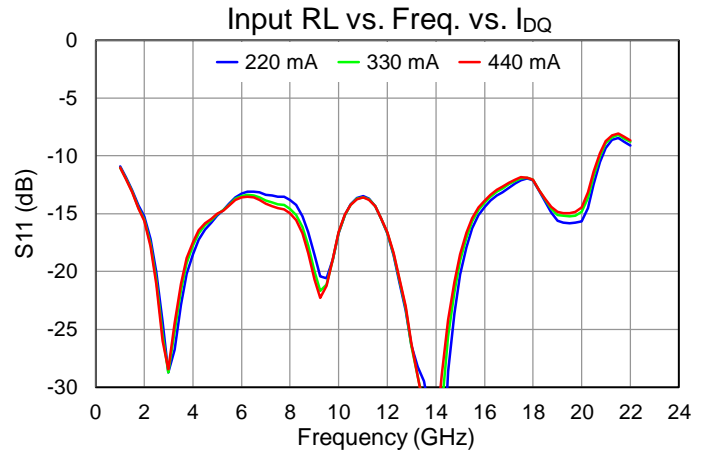
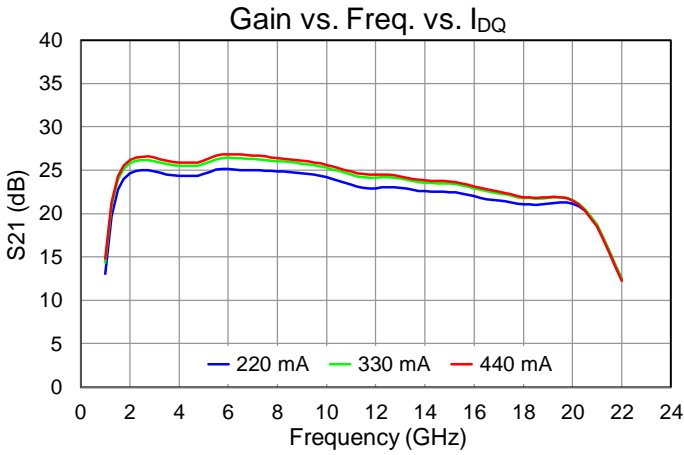

Performance Plots – Noise Figure

Test conditions, unless otherwise noted:  $V_D = 18\text{ V}$ ,  $I_{DQ} = 330\text{ mA}$ ,  $T = +25\text{ }^\circ\text{C}$

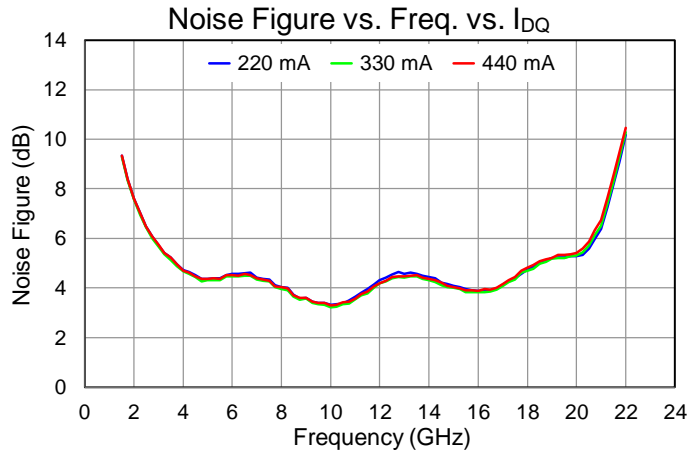
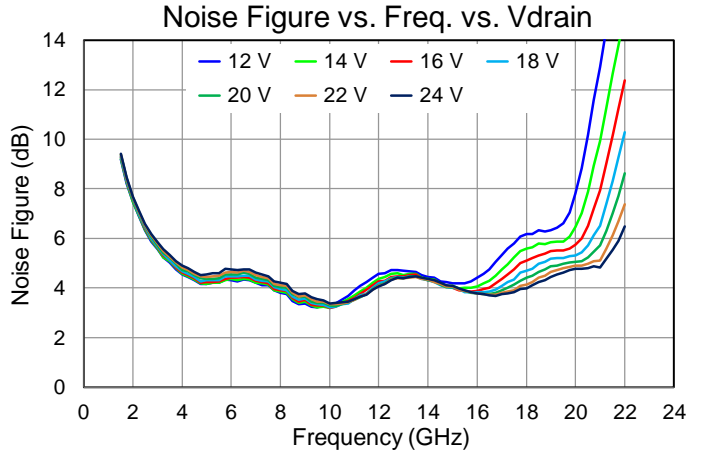
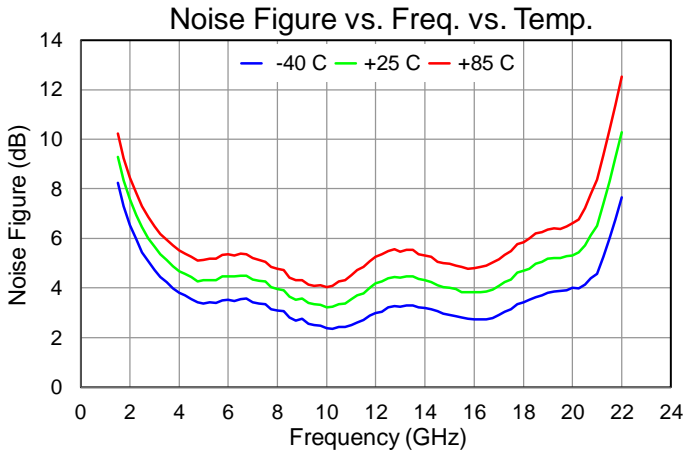

Performance Plots – Large Signal

Test conditions, unless otherwise noted:  $V_D = 18\text{ V}$ ,  $I_{DQ} = 330\text{ mA}$ ,  $T = +25\text{ }^\circ\text{C}$ ,  $P_{in} = 18\text{ dBm}$

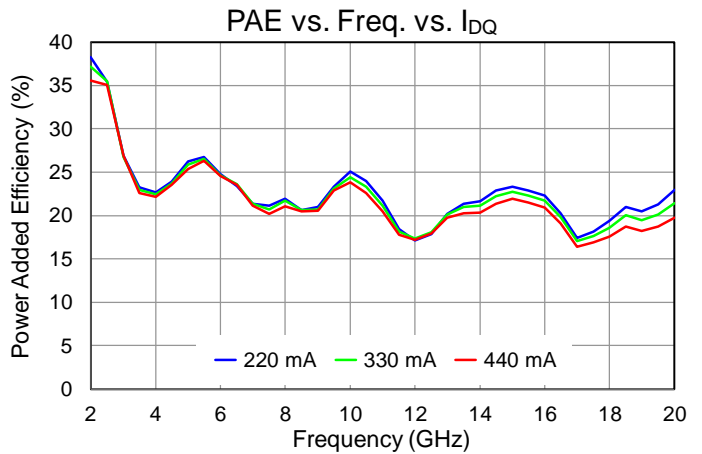
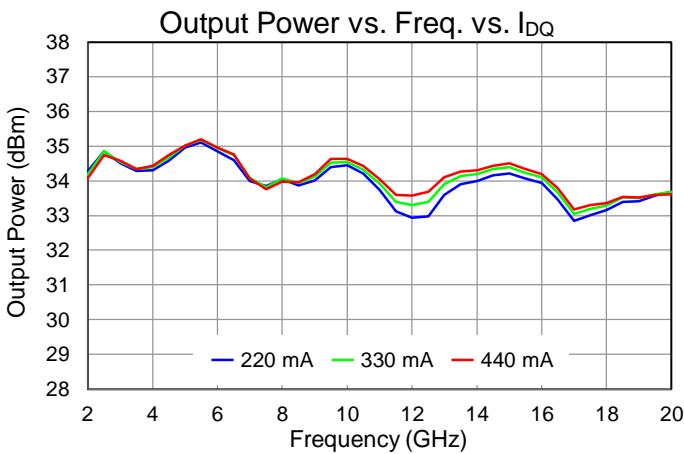
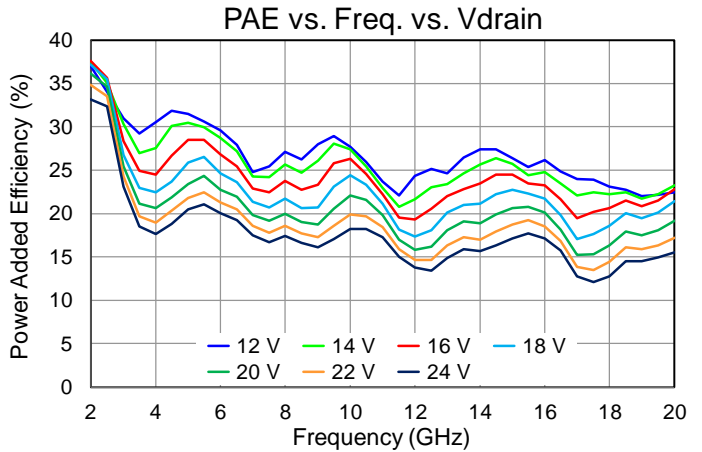
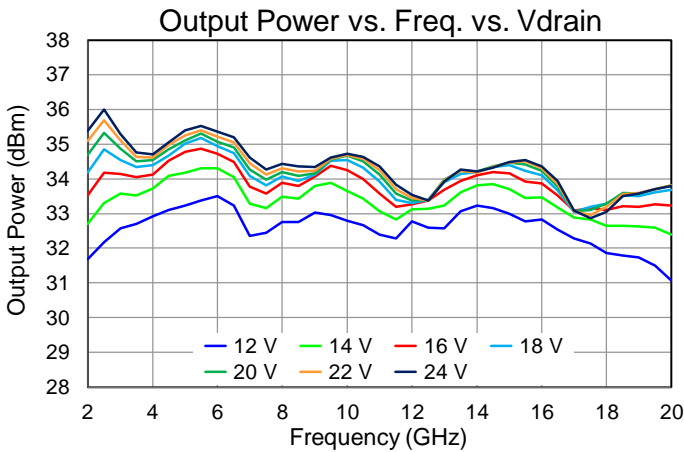
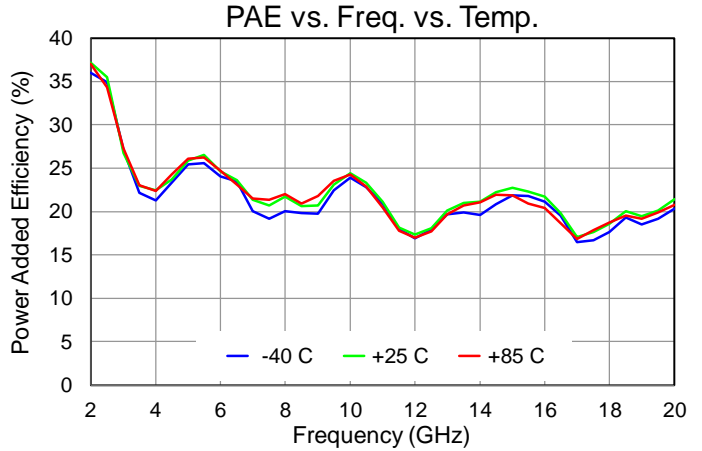
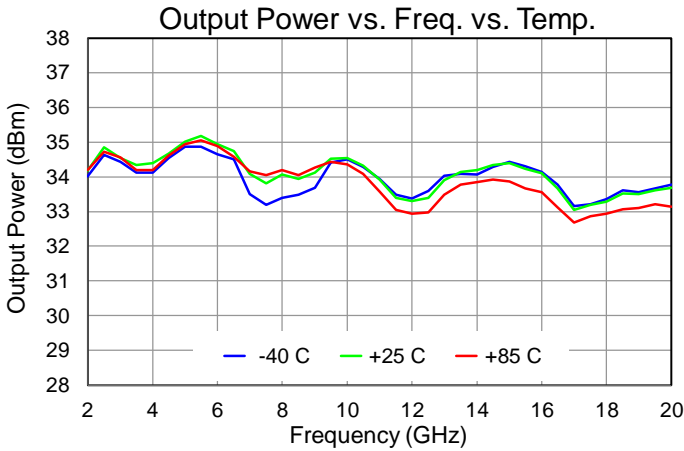

Performance Plots – Large Signal

Test conditions, unless otherwise noted:  $V_D = 18\text{ V}$ ,  $I_{DQ} = 330\text{ mA}$ ,  $T = +25\text{ }^\circ\text{C}$ ,  $P_{in} = 18\text{ dBm}$

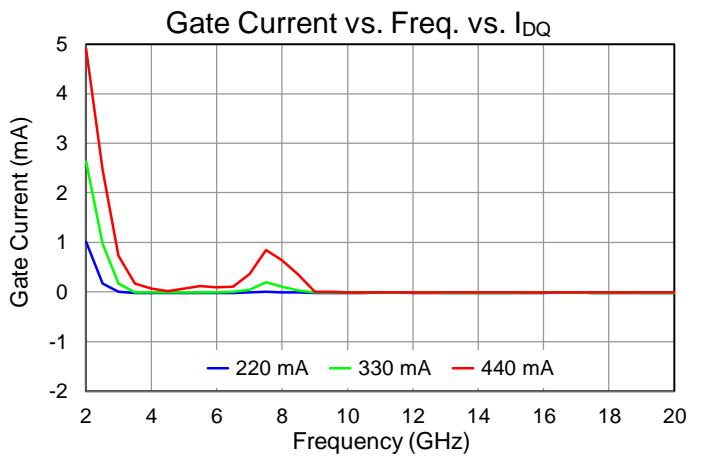
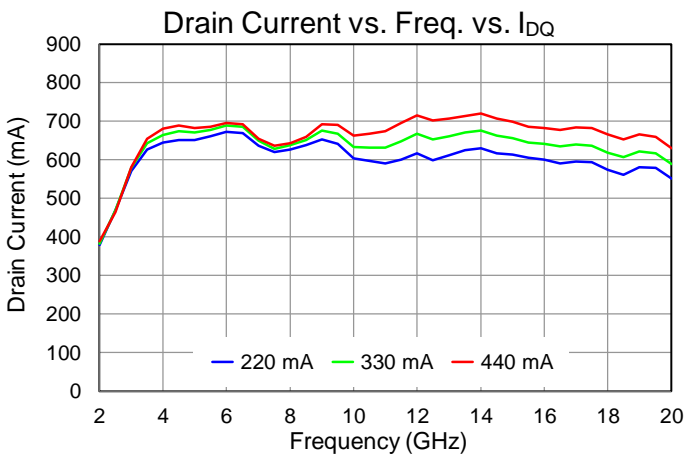
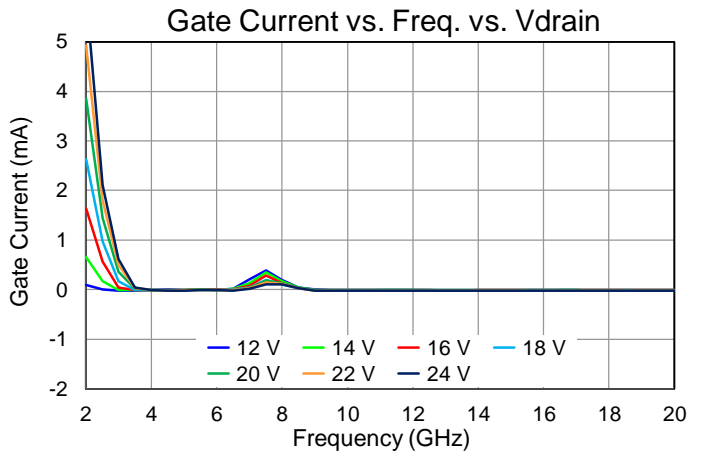
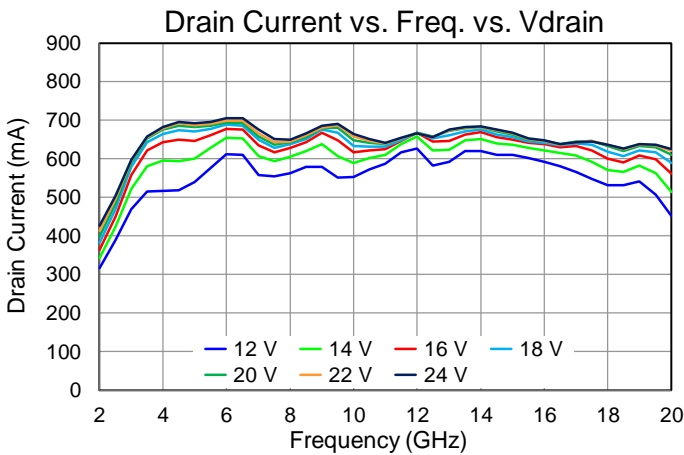
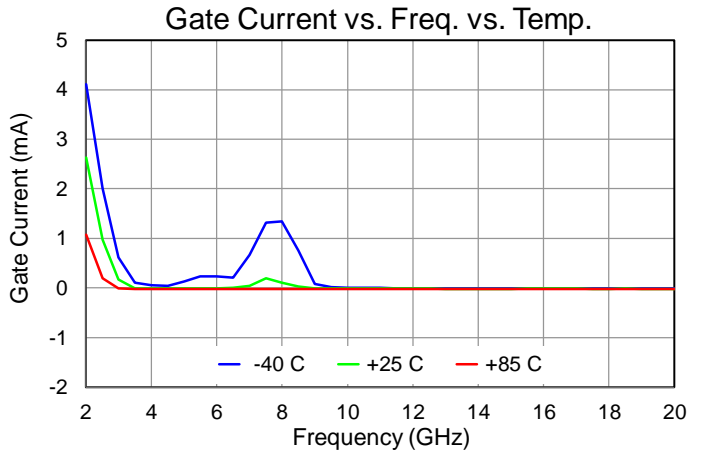
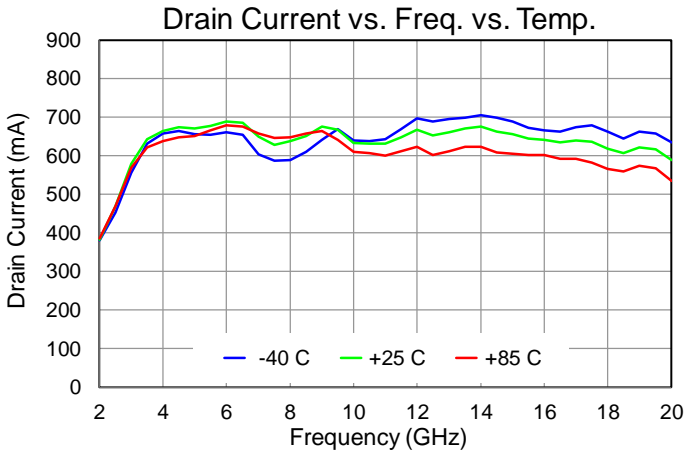



## Performance Plots – Large Signal

Test conditions, unless otherwise noted:  $V_D = 18\text{ V}$ ,  $I_{DQ} = 330\text{ mA}$ ,  $T = +25\text{ }^\circ\text{C}$

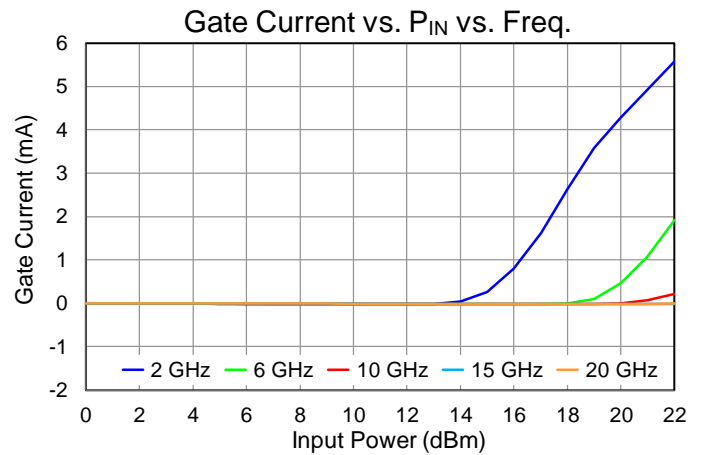
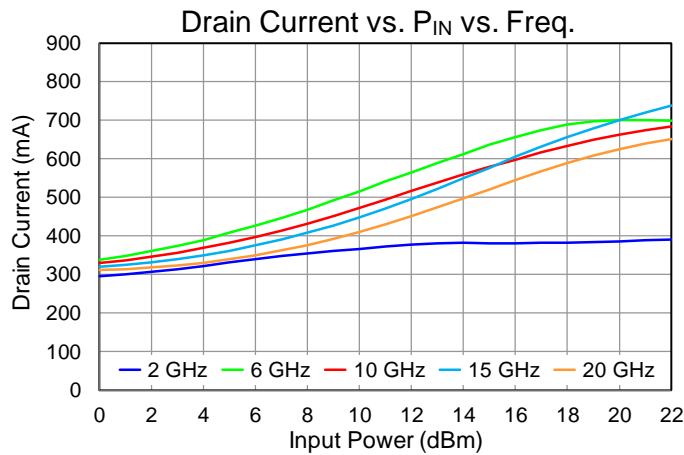
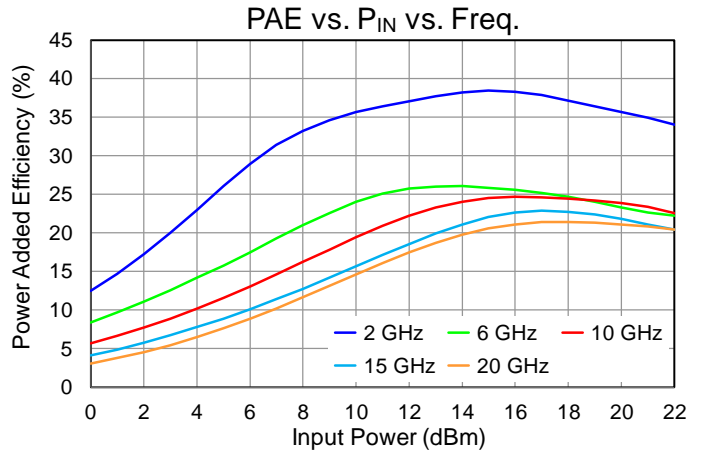
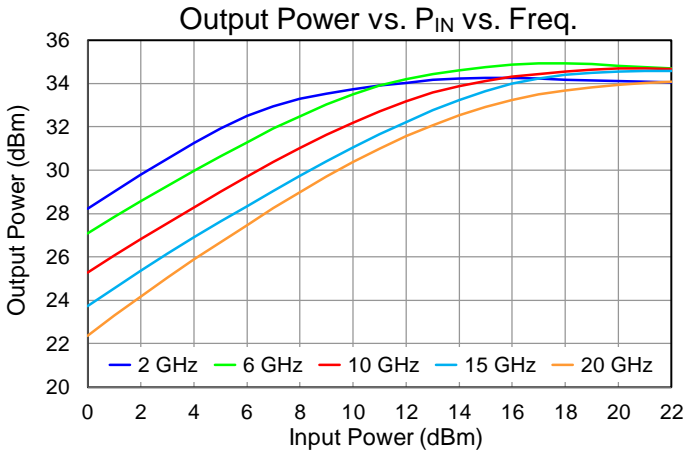

Performance Plots – Large Signal

Test conditions, unless otherwise noted:  $V_D = 18\text{ V}$ ,  $I_{DQ} = 330\text{ mA}$ ,  $T = +25\text{ }^\circ\text{C}$

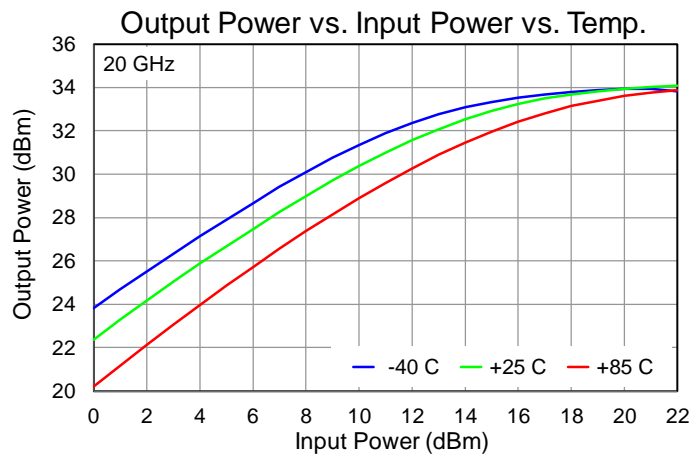
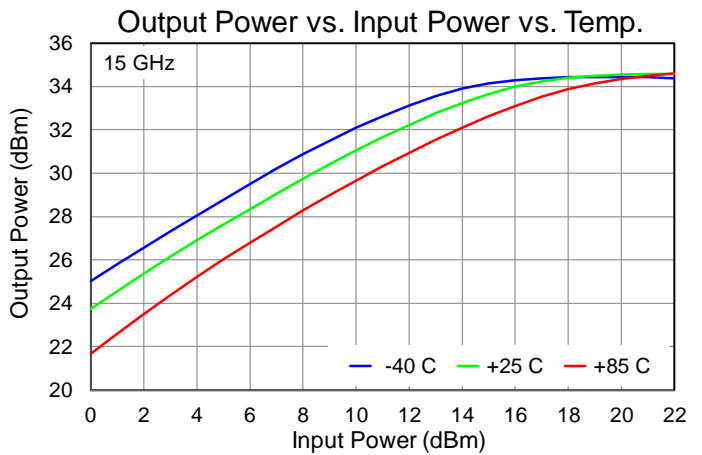
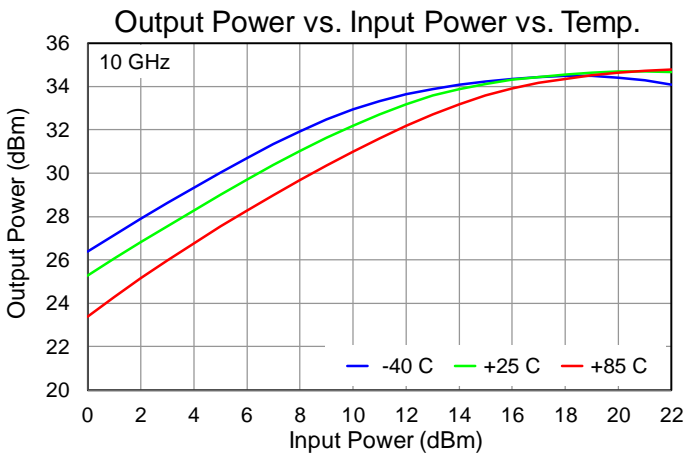
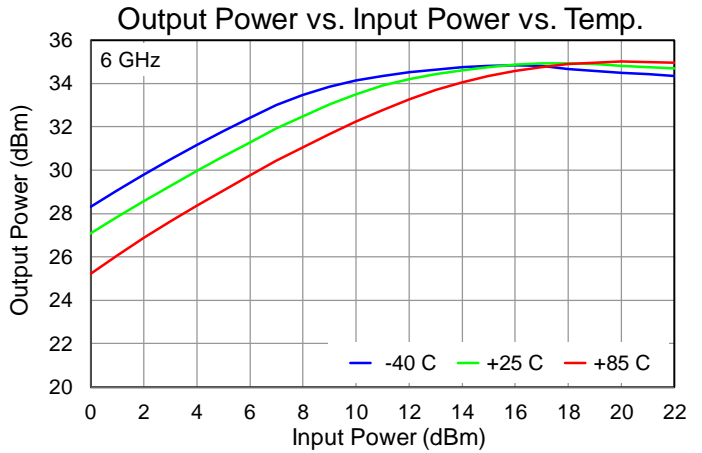
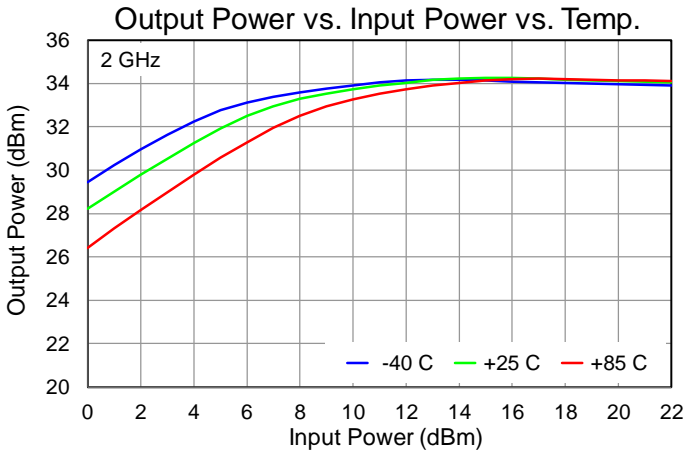

Performance Plots – Large Signal

Test conditions, unless otherwise noted:  $V_D = 18\text{ V}$ ,  $I_{DQ} = 330\text{ mA}$ ,  $T = +25\text{ }^\circ\text{C}$

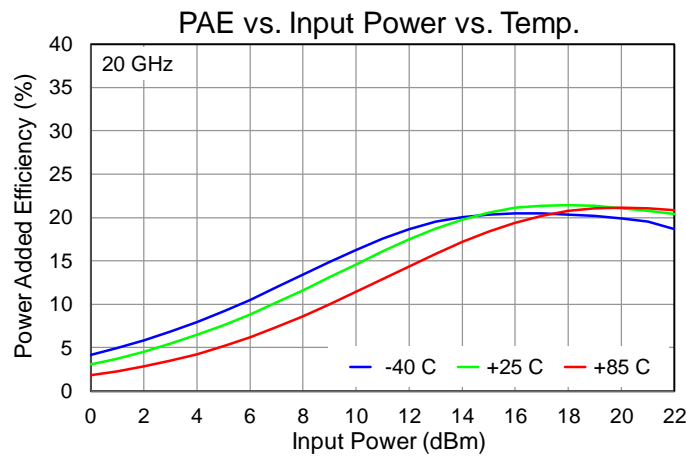
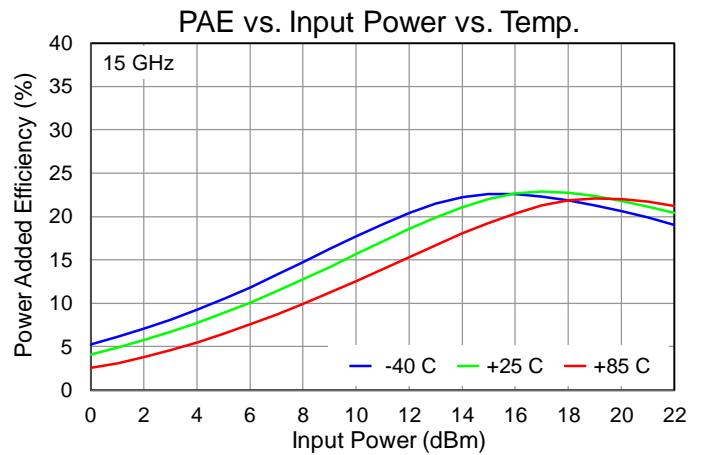
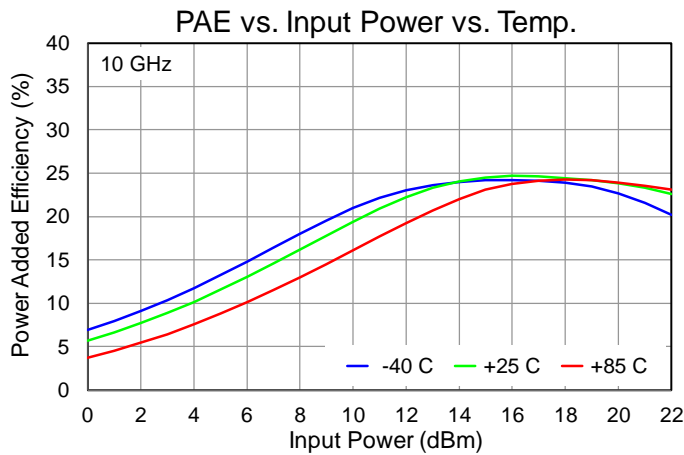
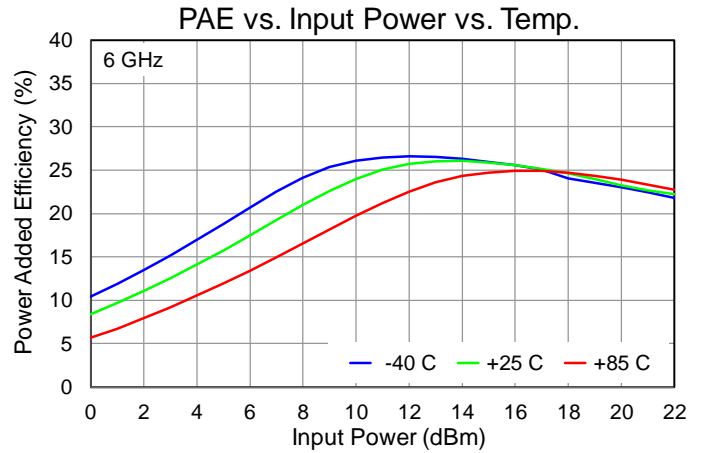
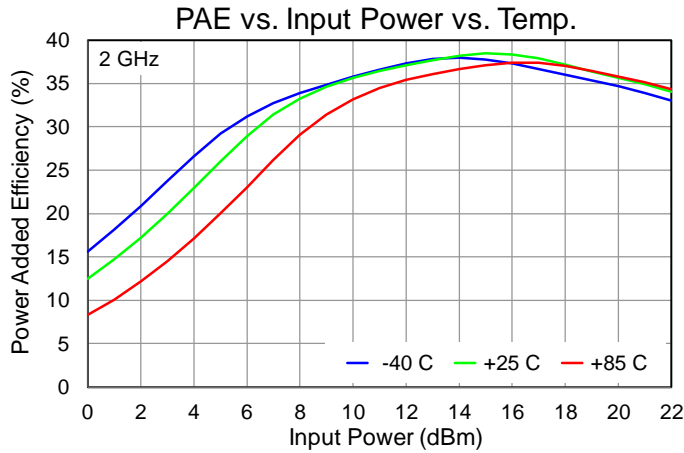

Performance Plots – Large Signal

Test conditions, unless otherwise noted:  $V_D = 18\text{ V}$ ,  $I_{DQ} = 330\text{ mA}$ ,  $T = +25\text{ }^\circ\text{C}$

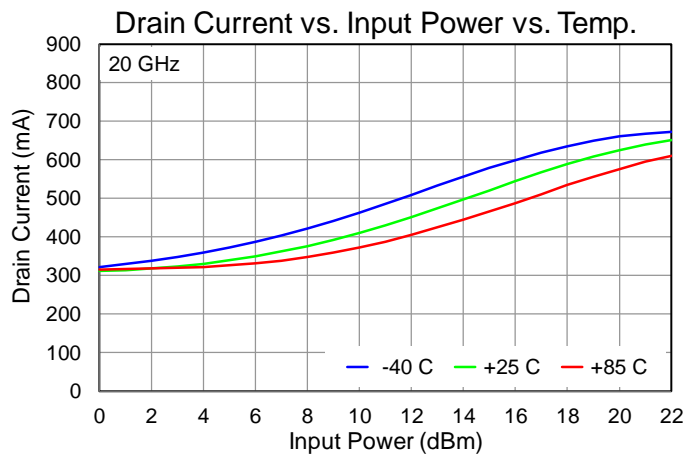
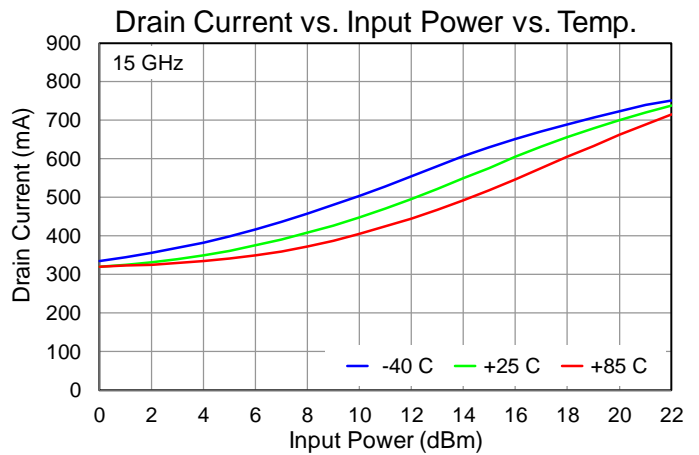
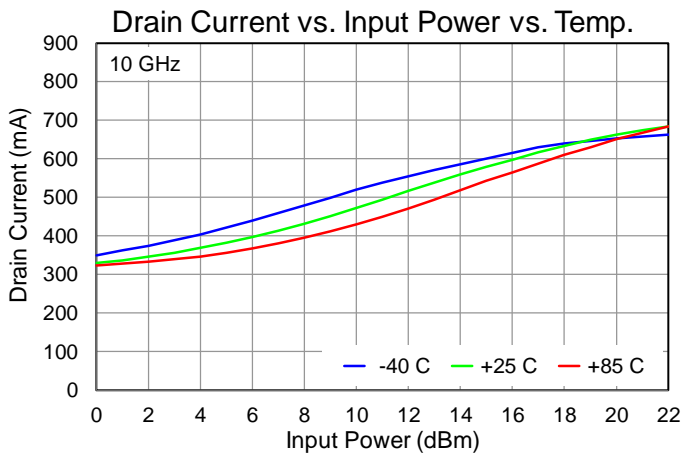
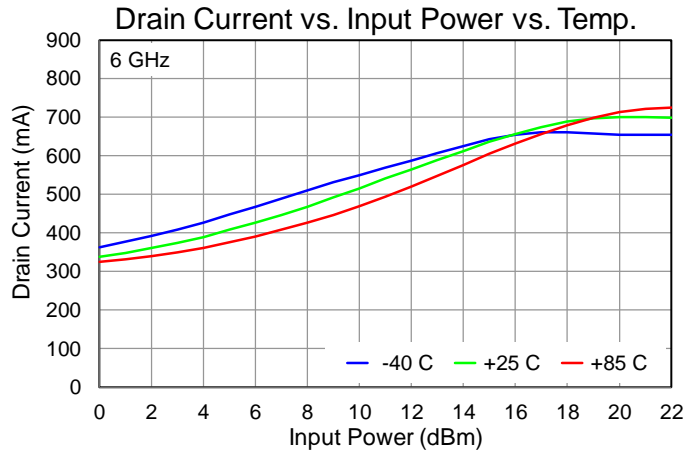
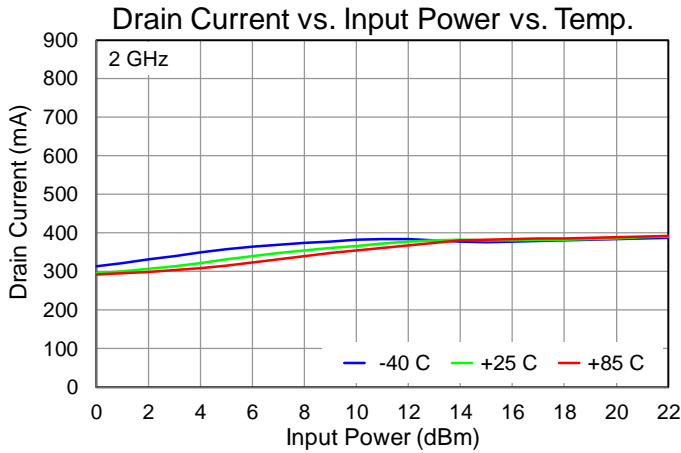

Performance Plots – Large Signal

Test conditions, unless otherwise noted:  $V_D = 18\text{ V}$ ,  $I_{DQ} = 330\text{ mA}$ ,  $T = +25\text{ }^\circ\text{C}$

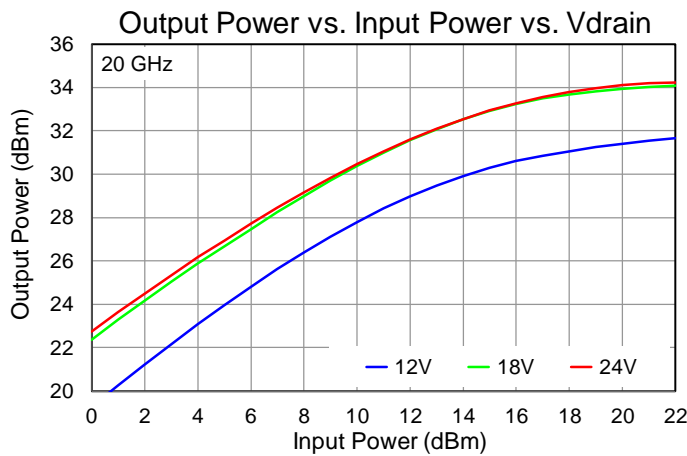
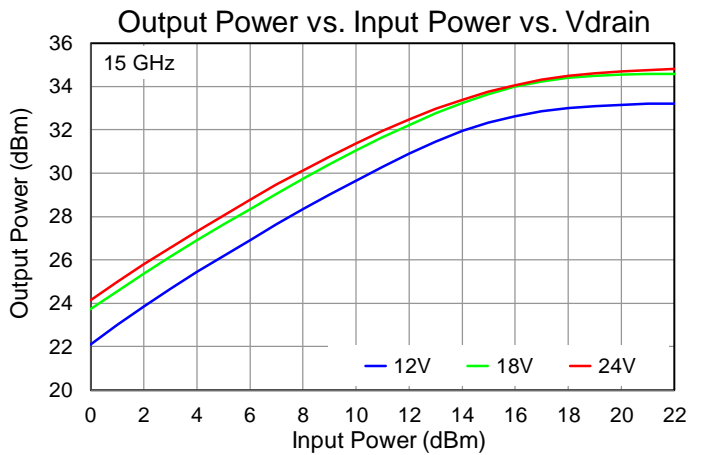
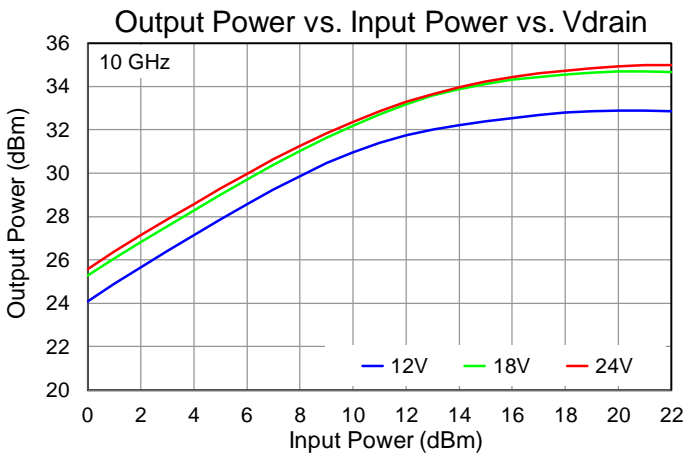
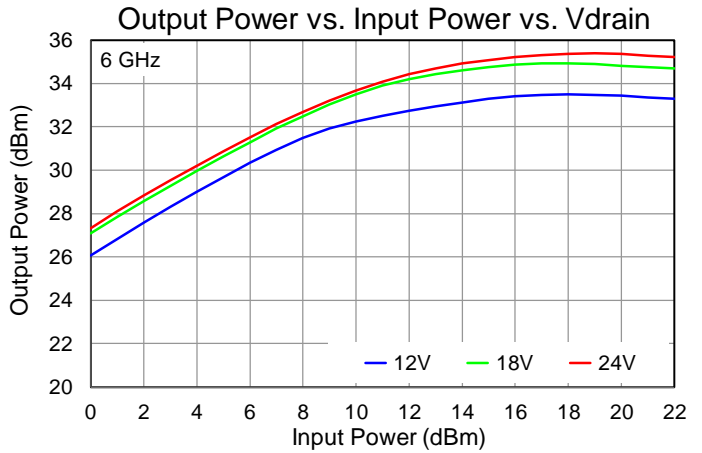
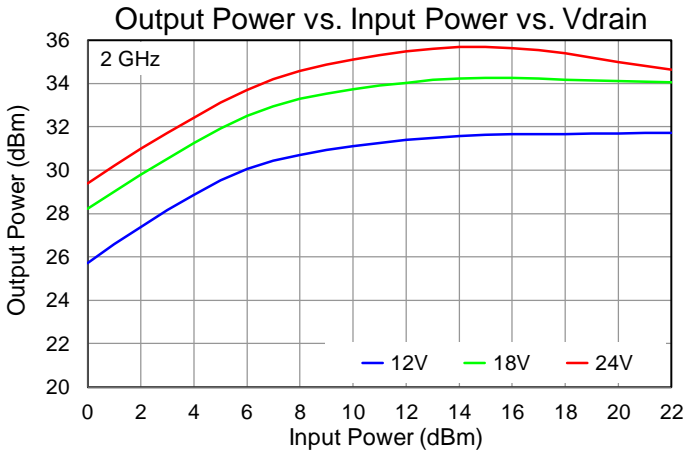

Performance Plots – Large Signal

Test conditions, unless otherwise noted:  $V_D = 18\text{ V}$ ,  $I_{DQ} = 330\text{ mA}$ ,  $T = +25\text{ }^\circ\text{C}$

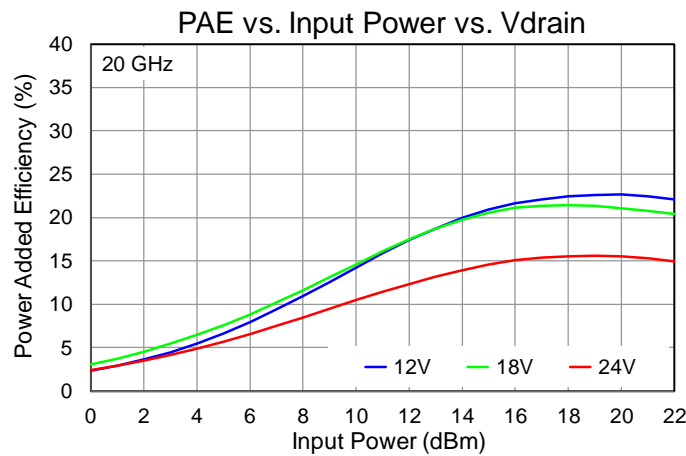
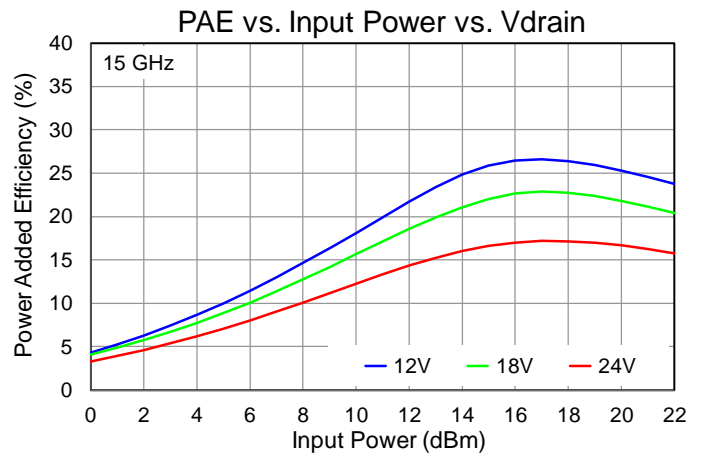
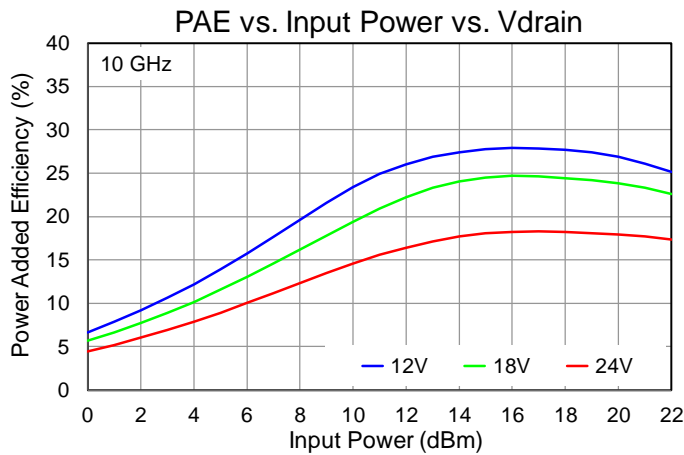
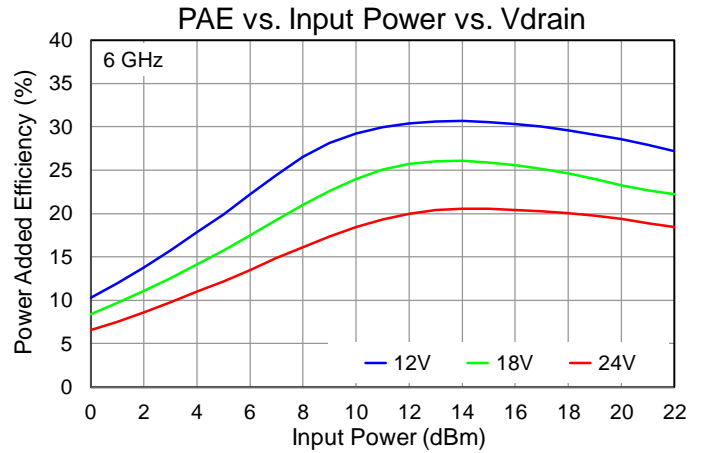
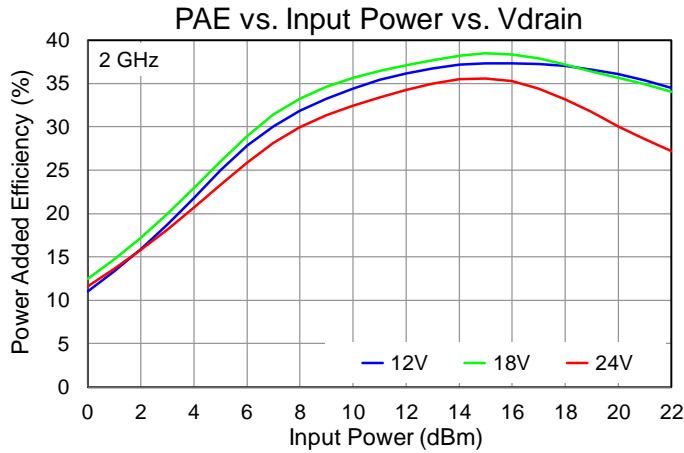

Performance Plots – Large Signal

Test conditions, unless otherwise noted:  $V_D = 18\text{ V}$ ,  $I_{DQ} = 330\text{ mA}$ ,  $T = +25\text{ }^\circ\text{C}$

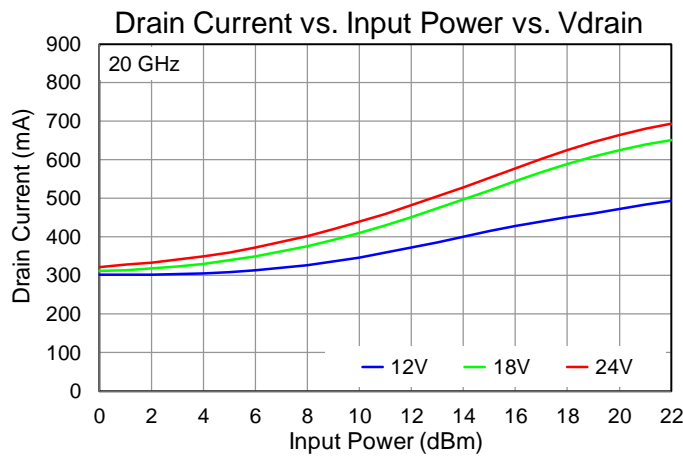
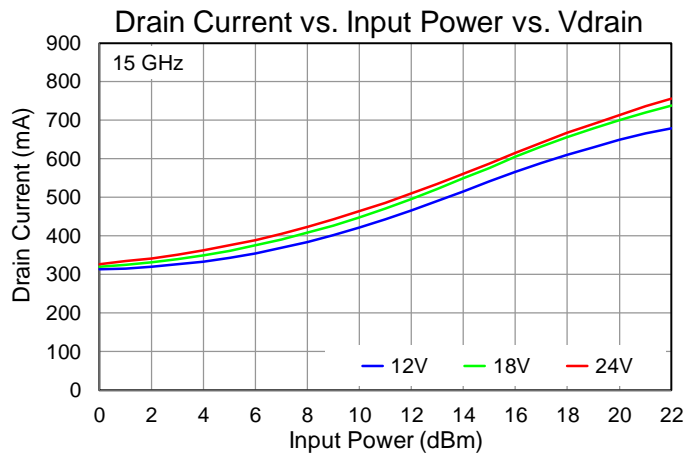
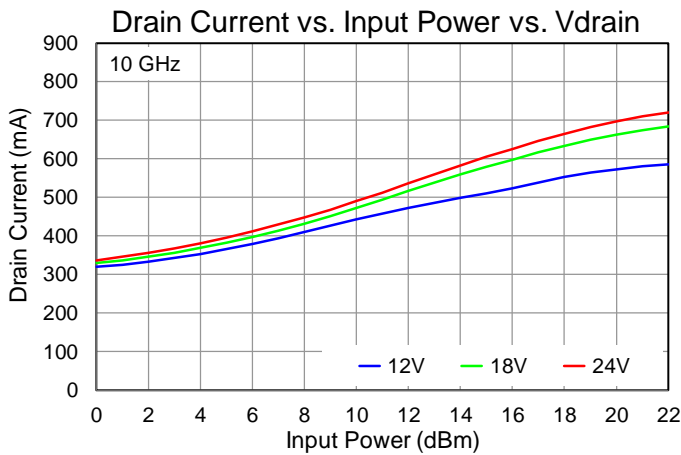
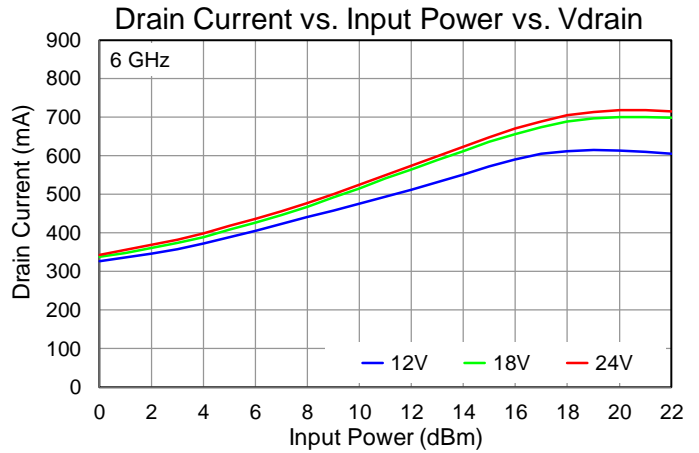
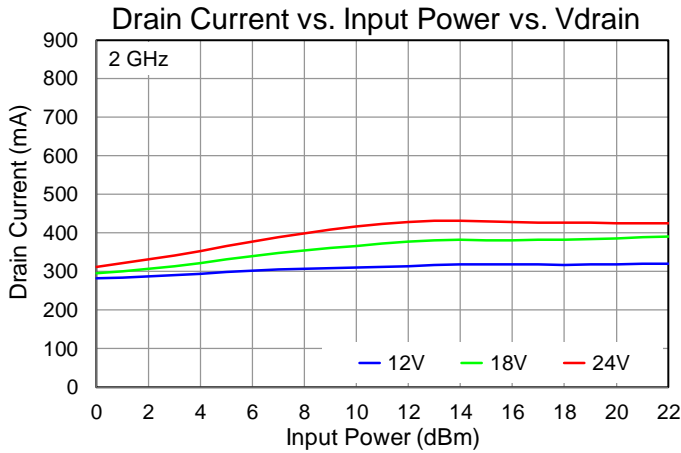

Performance Plots – Large Signal

Test conditions, unless otherwise noted:  $V_D = 18\text{ V}$ ,  $I_{DQ} = 330\text{ mA}$ ,  $T = +25\text{ }^\circ\text{C}$

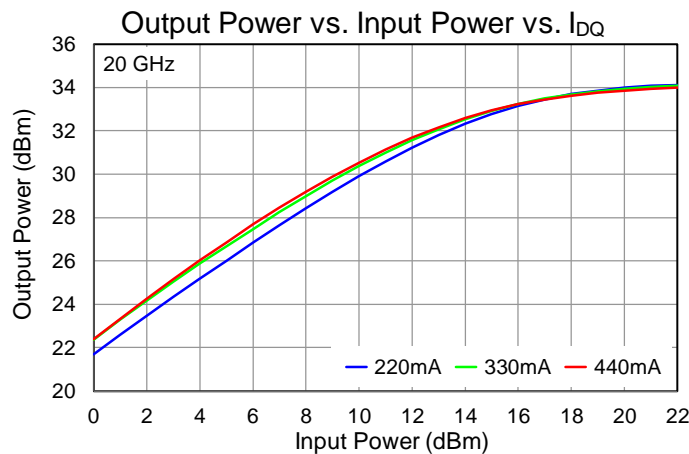
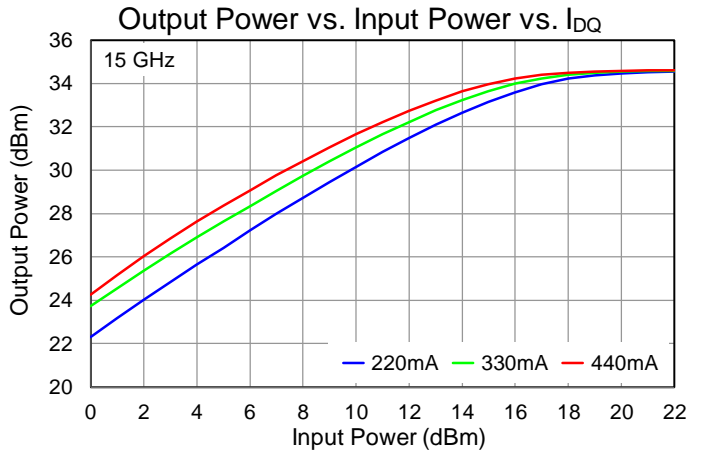
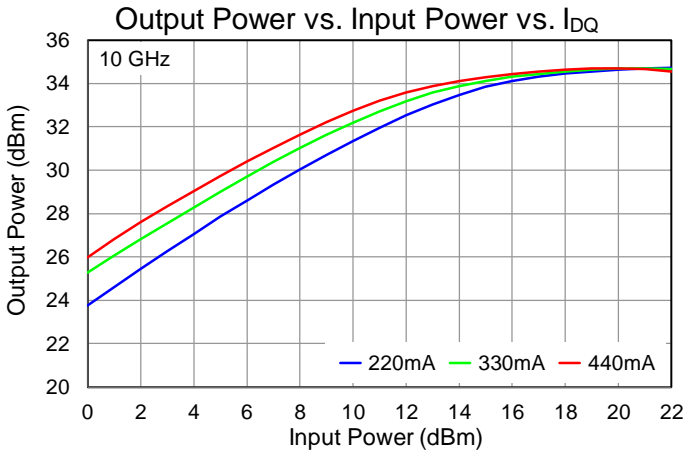
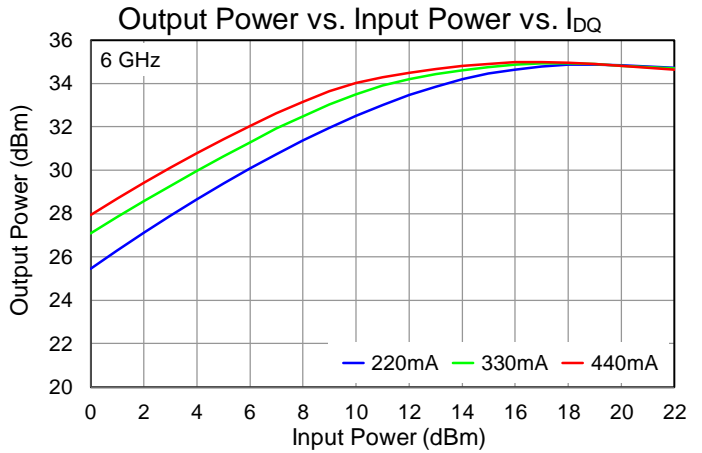
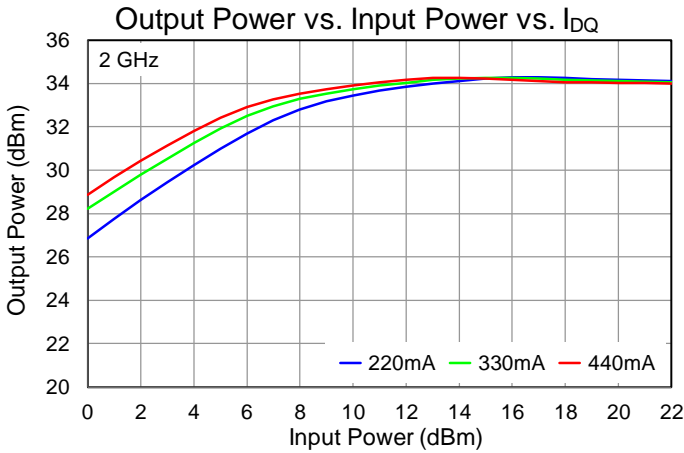



**Performance Plots – Large Signal**

Test conditions, unless otherwise noted:  $V_D = 18\text{ V}$ ,  $I_{DQ} = 330\text{ mA}$ ,  $T = +25\text{ }^\circ\text{C}$

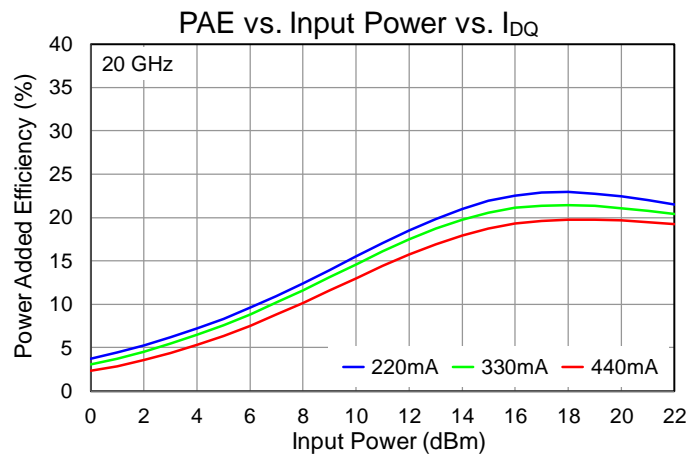
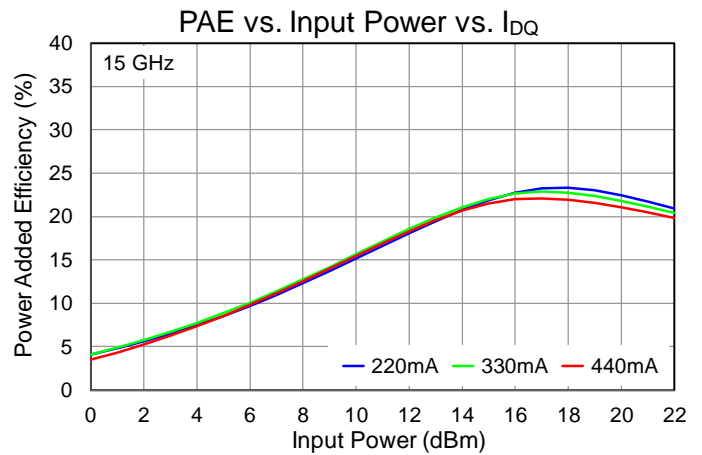
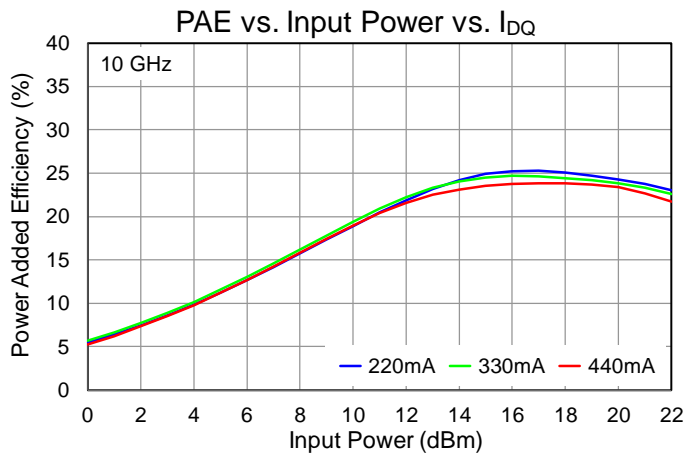
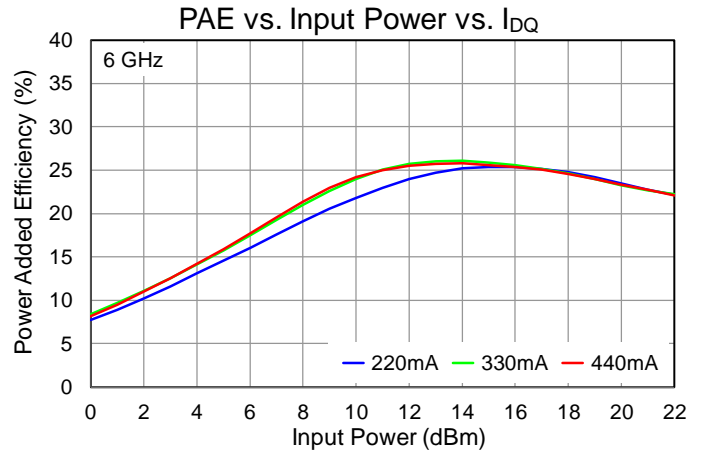
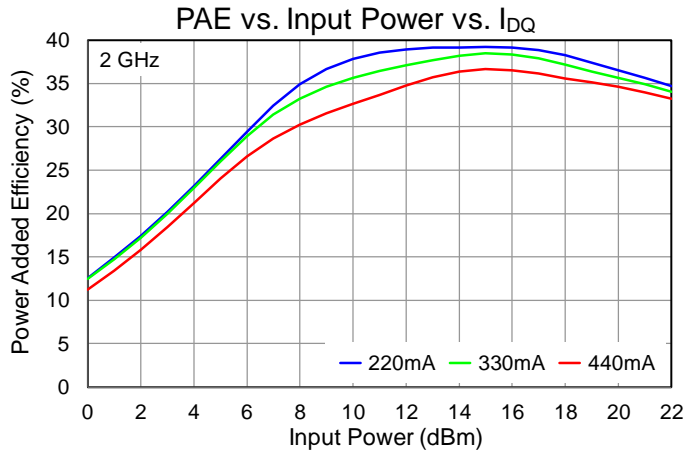

**Performance Plots – Large Signal**

Test conditions, unless otherwise noted:  $V_D = 18\text{ V}$ ,  $I_{DQ} = 330\text{ mA}$ ,  $T = +25\text{ }^\circ\text{C}$

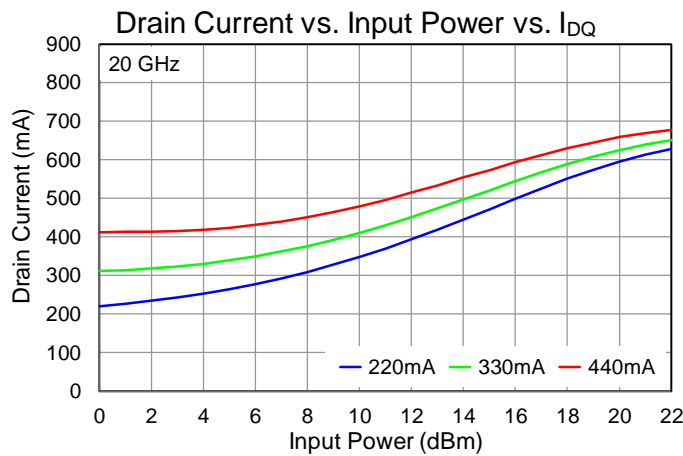
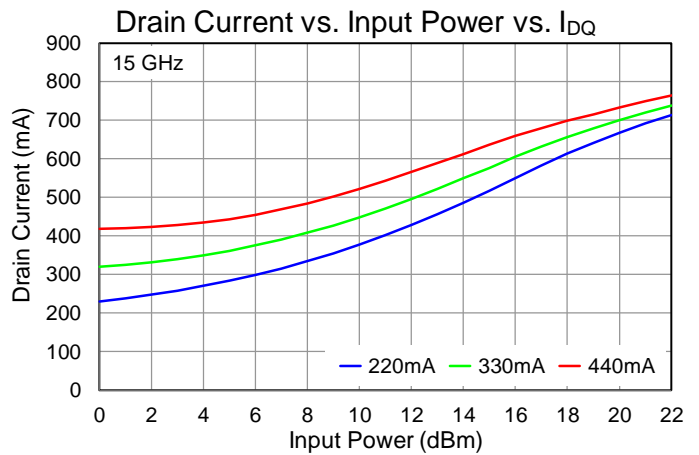
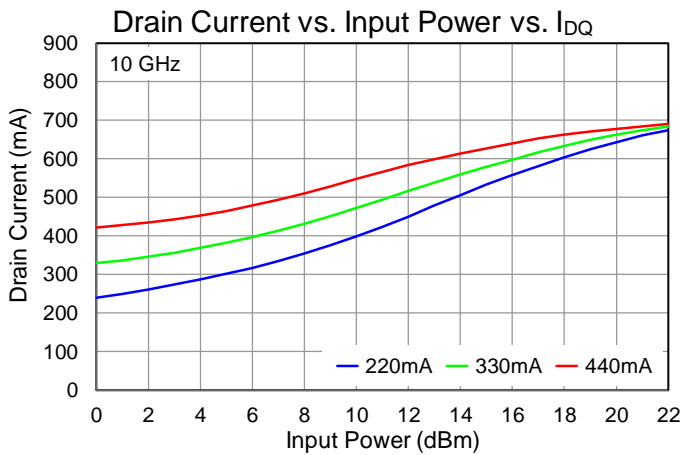
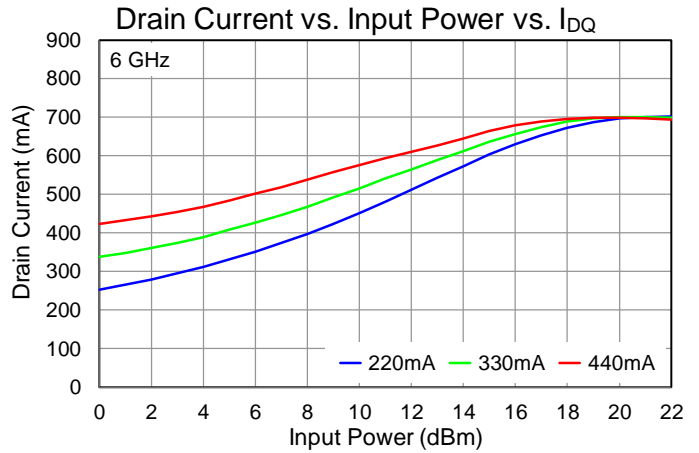
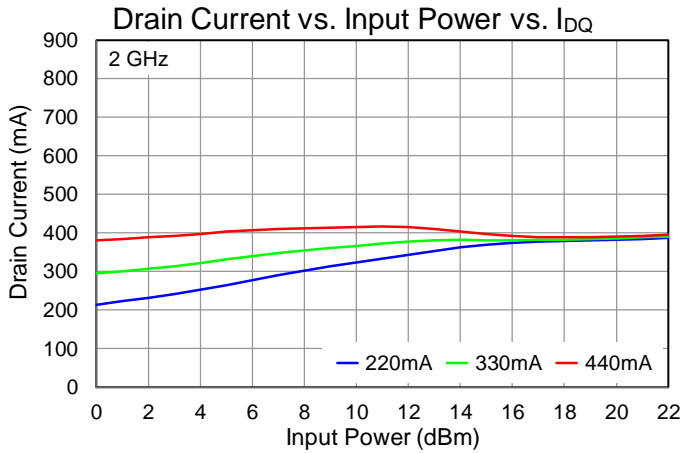

Performance Plots – Linearity

Test conditions, unless otherwise noted:  $V_D = 18\text{ V}$ ,  $I_{DQ} = 330\text{ mA}$ ,  $T = +25\text{ }^\circ\text{C}$ , 100 MHz tone spacing

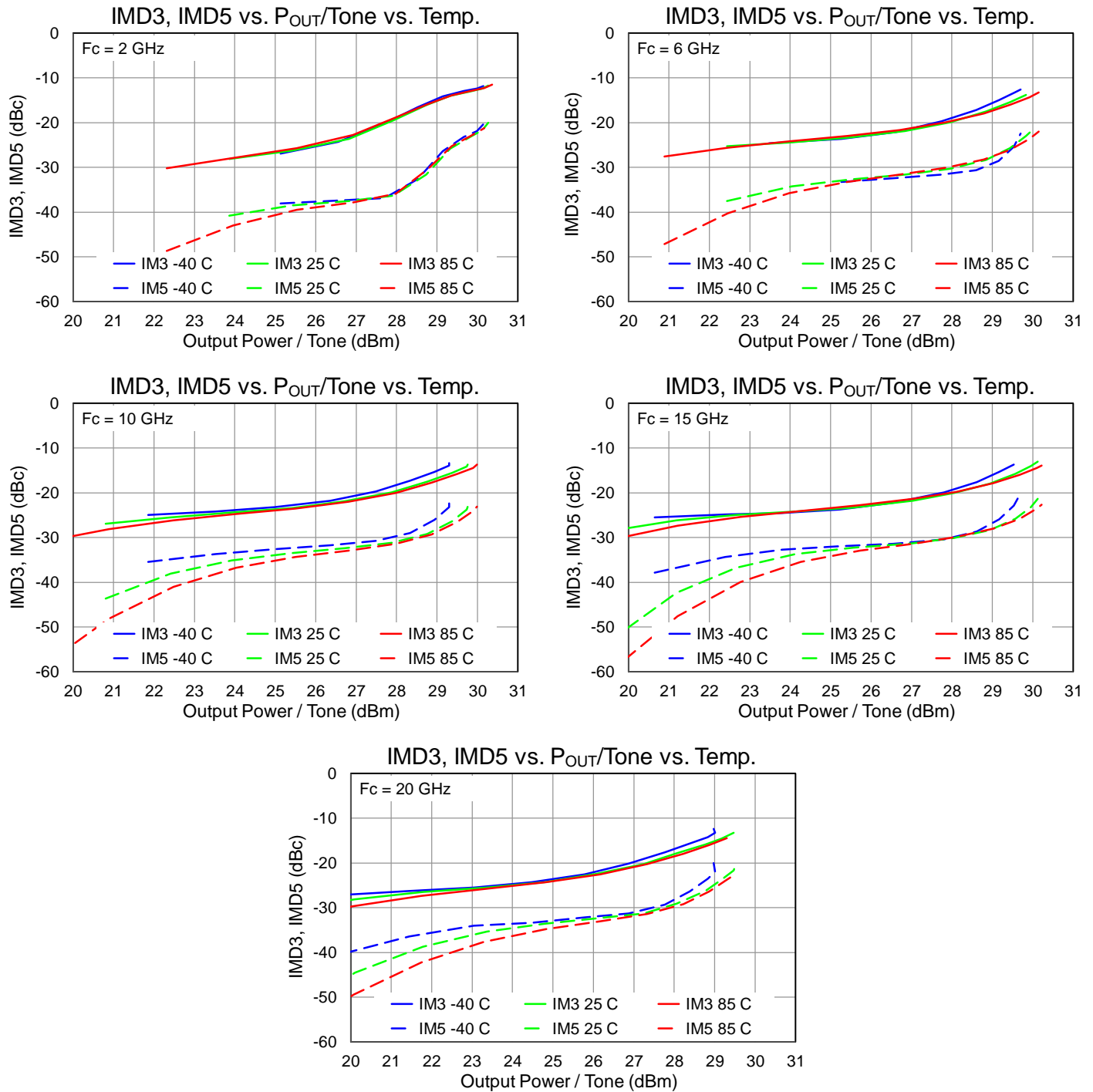

Performance Plots – Linearity

Test conditions, unless otherwise noted:  $V_D = 18\text{ V}$ ,  $I_{DQ} = 330\text{ mA}$ ,  $T = +25\text{ }^\circ\text{C}$ , 100 MHz tone spacing

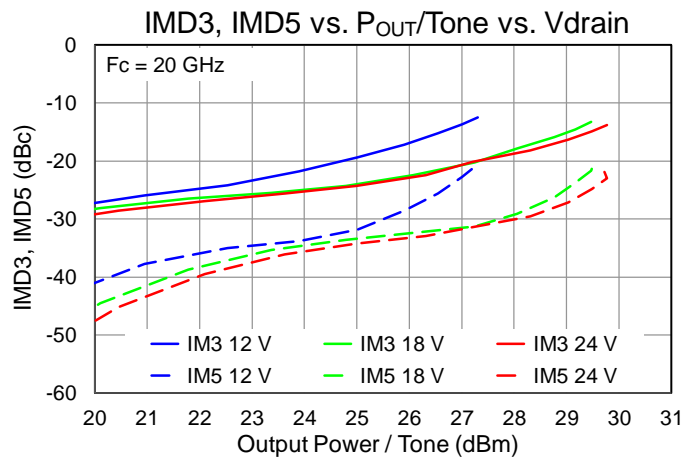
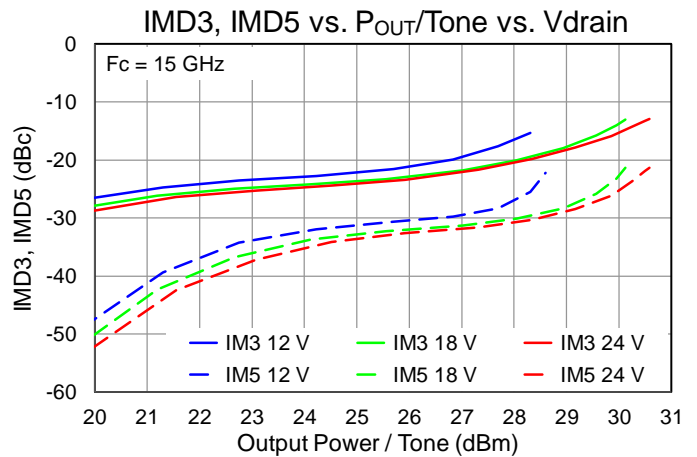
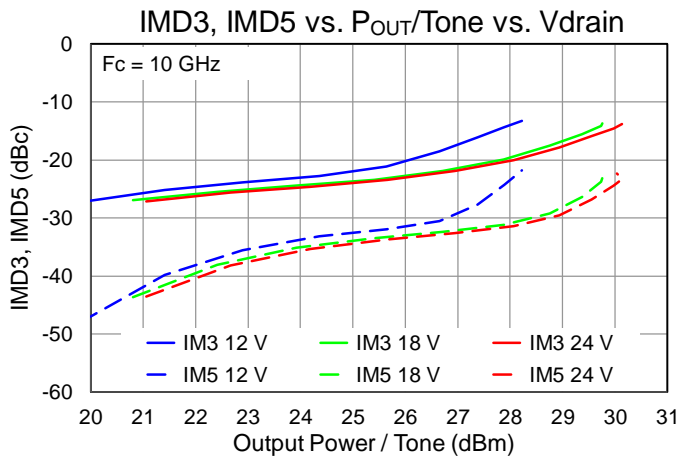
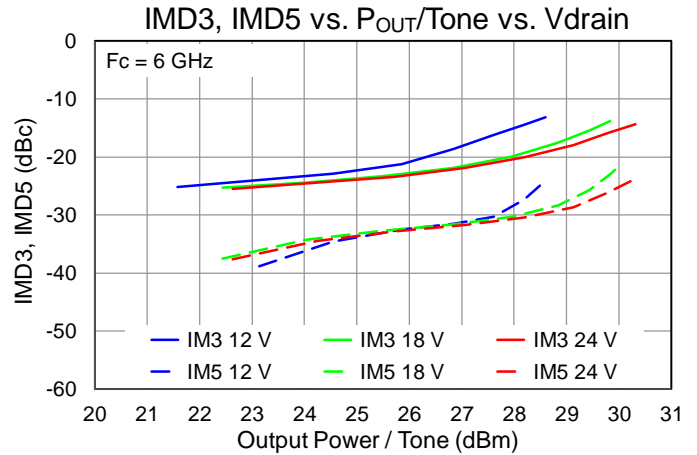
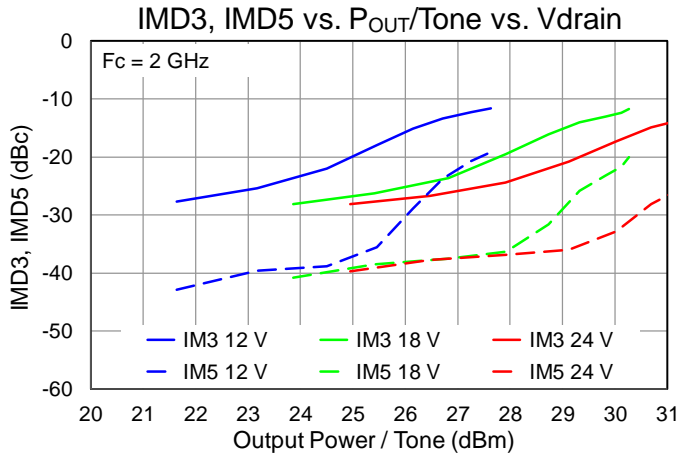

Performance Plots – Linearity

Test conditions, unless otherwise noted:  $V_D = 18\text{ V}$ ,  $I_{DQ} = 330\text{ mA}$ ,  $T = +25\text{ }^\circ\text{C}$ , 100 MHz tone spacing

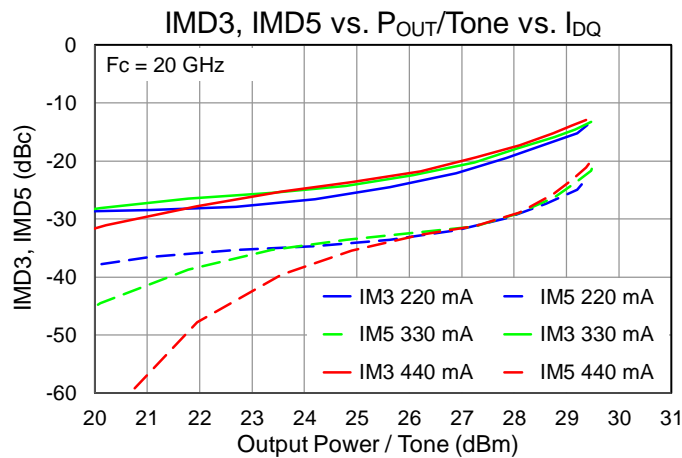
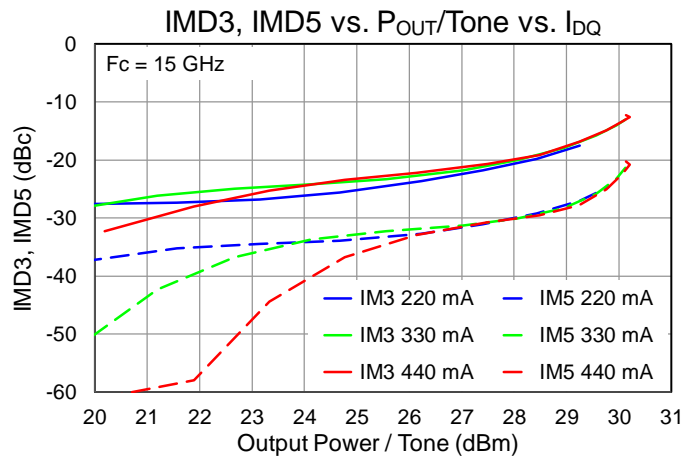
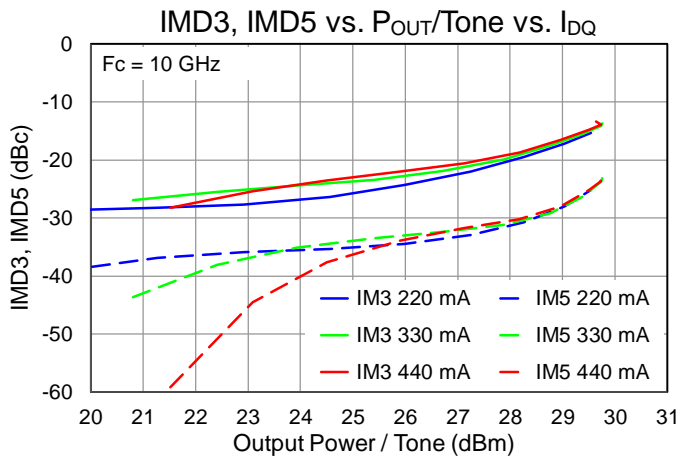
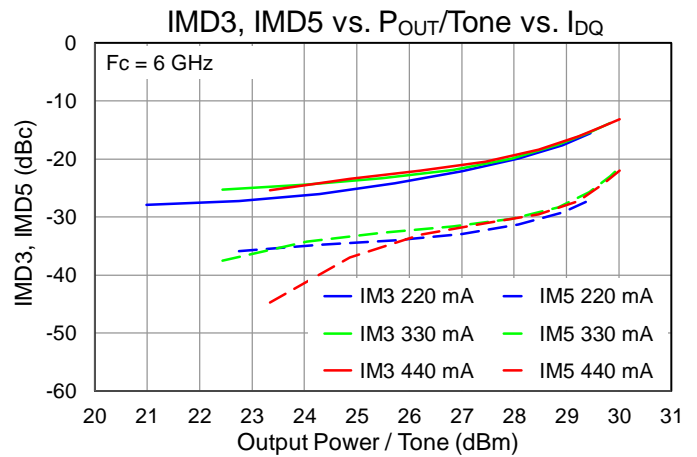
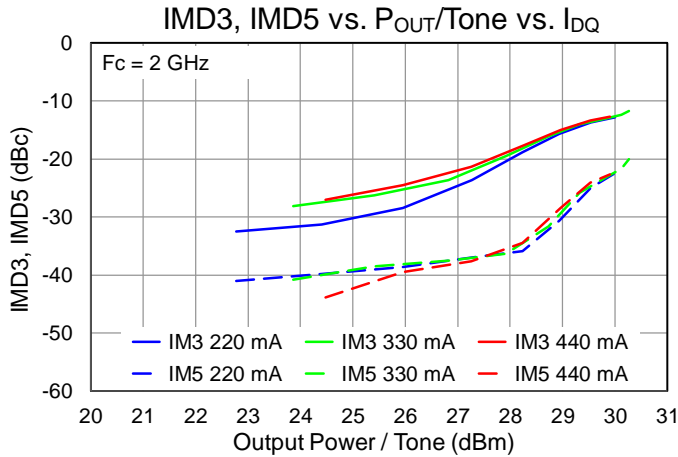

Performance Plots – Harmonics

Test conditions, unless otherwise noted:  $V_D = 18\text{ V}$ ,  $I_{DQ} = 330\text{ mA}$ ,  $T = +25\text{ }^\circ\text{C}$ ,  $P_{in} = 18\text{ dBm}$

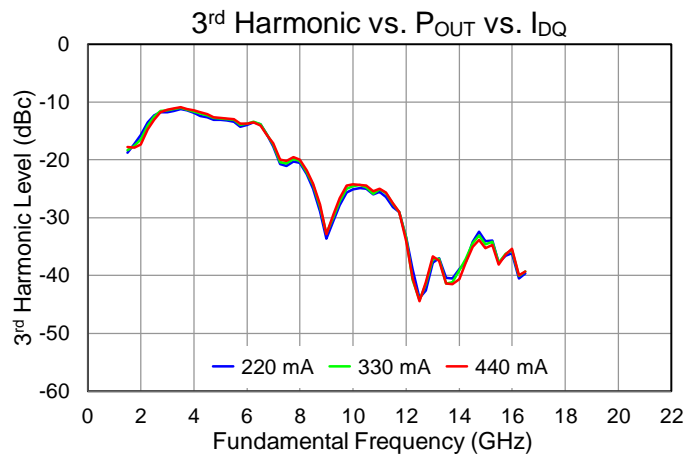
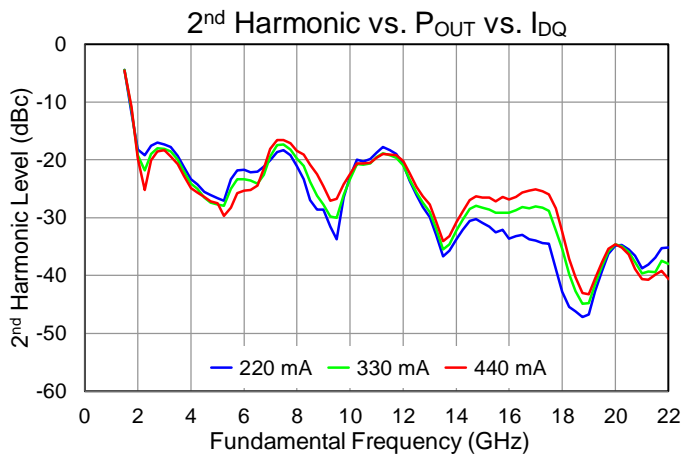
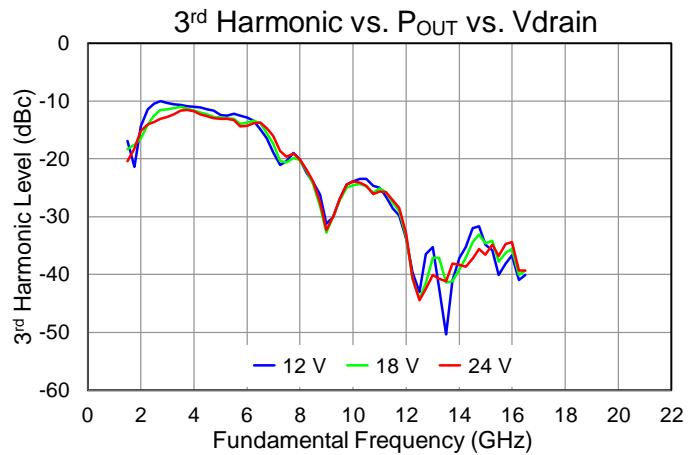
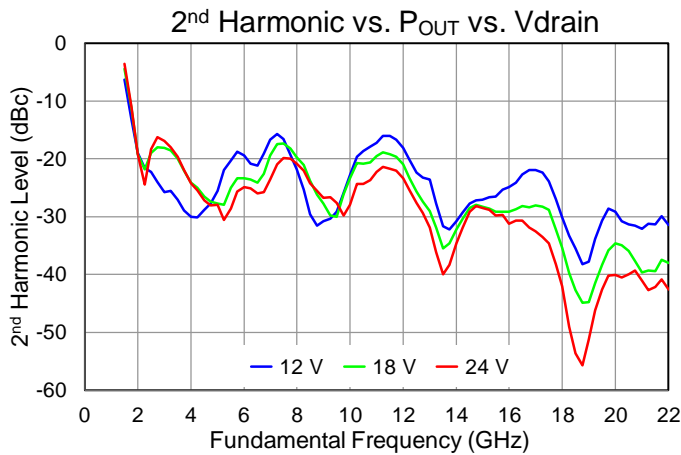
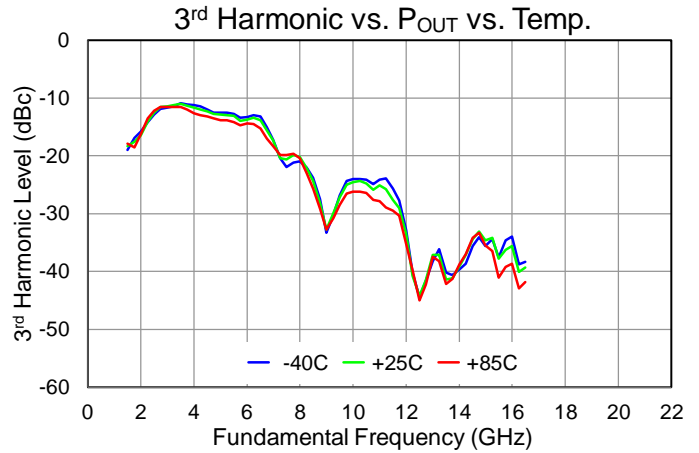
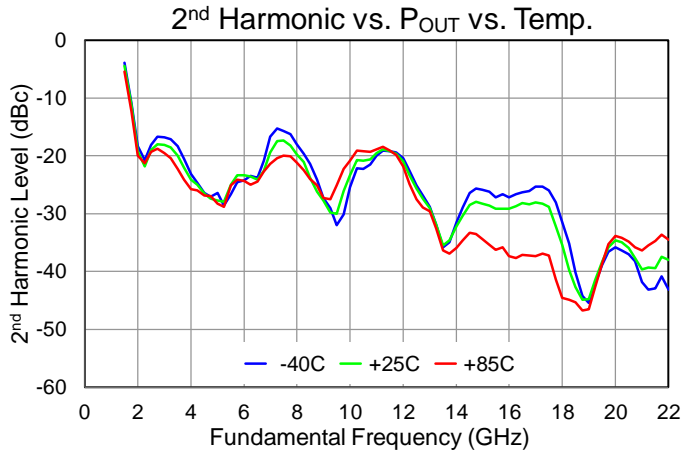

## Thermal and Reliability Information

Parameter	Test Conditions	Value	Units
Thermal Resistance ( $\theta_{JC}$ ) <sup>(1)</sup>	$T_{base} = 85\text{ }^{\circ}\text{C}$ , $V_D = 18\text{ V}$ , $I_{DQ} = 330\text{ mA}$ , $P_{DISS} = 5.94\text{ W}$ , No RF (quiescent DC operation)	5.16	$^{\circ}\text{C/W}$
Channel Temperature, $T_{CH}$ (Under RF) <sup>(2)</sup>		116	$^{\circ}\text{C}$
Thermal Resistance ( $\theta_{JC}$ ) <sup>(1)</sup>	$T_{base} = 85\text{ }^{\circ}\text{C}$ , $V_D = 18\text{ V}$ , $I_{DQ} = 330\text{ mA}$ , $\text{Freq} = 6.5\text{ GHz}$ , $I_{D\_Drive} = 676\text{ mA}$ , $P_{IN} = 18\text{ dBm}$ , $P_{OUT} = 34.6\text{ dBm}$ , $P_{DISS} = 9.36\text{ W}$	7.15	$^{\circ}\text{C/W}$
Channel Temperature, $T_{CH}$ (Under RF) <sup>(2)</sup>		152	$^{\circ}\text{C}$
Thermal Resistance ( $\theta_{JC}$ ) <sup>(1)</sup>	$T_{base} = 85\text{ }^{\circ}\text{C}$ , $V_D = 22\text{ V}$ , $I_{DQ} = 330\text{ mA}$ , $\text{Freq} = 9.0\text{ GHz}$ , $I_{D\_Drive} = 679\text{ A}$ , $P_{IN} = 18\text{ dBm}$ , $P_{OUT} = 34.4\text{ dBm}$ , $P_{DISS} = 12.25\text{ W}$	7.31	$^{\circ}\text{C/W}$
Channel Temperature, $T_{CH}$ (Under RF) <sup>(2)</sup>		175	$^{\circ}\text{C}$

**Notes:**

1. Thermal resistance determined to the back of package ( $85\text{ }^{\circ}\text{C}$ )
2. Refer to the following document: [GaN Device Channel Temperature, Thermal Resistance, and Reliability Estimates](#)

## Dissipated Power and Maximum Gate Current

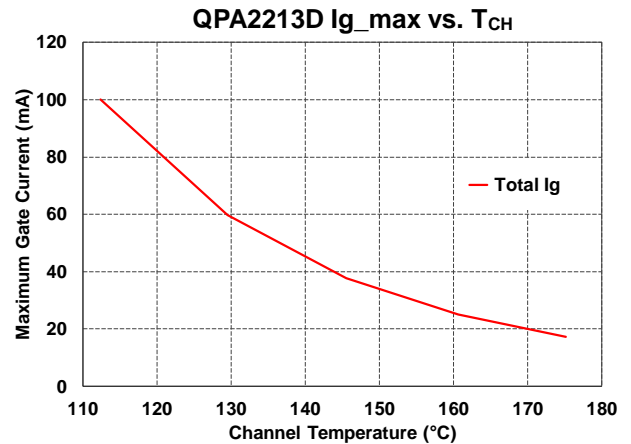
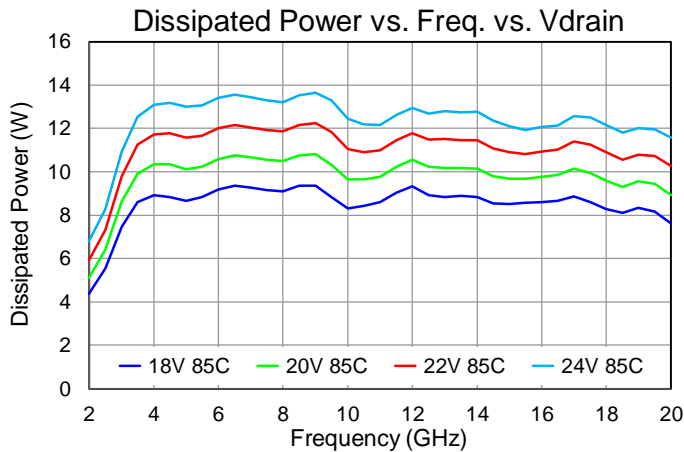

Test conditions, unless otherwise noted:  $V_D = 18\text{ V}$ ,  $I_{DQ} = 330\text{ mA}$ ,  $T = +25\text{ }^{\circ}\text{C}$ ,  $P_{in} = 18\text{ dBm}$

Applications Information

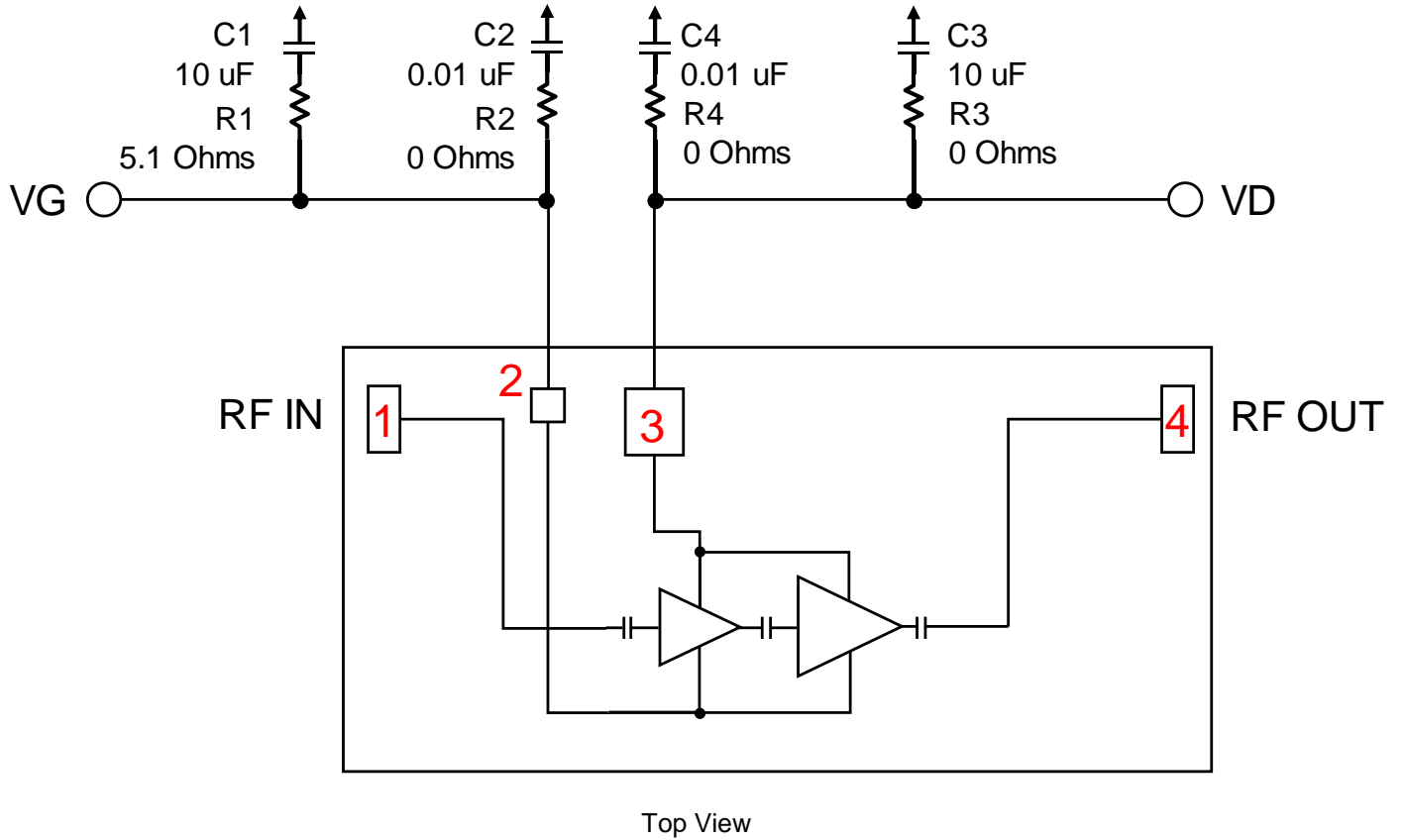

Bias-Up Procedure

1. Set  $I_D$  limit to 900 mA,  $I_G$  limit to 10 mA
2. Set  $V_G$  to -4.0 V
3. Set  $V_D$  +18 V
4. Adjust  $V_G$  more positive until  $I_{DQ} \approx 330$  mA
5. Apply RF signal

Bias-Down Procedure

1. Turn off RF signal
2. Reduce  $V_G$  to -4.0 V. Ensure  $I_{DQ} \sim 0$  mA
4. Set  $V_D$  to 0 V
5. Turn off  $V_D$  supply
6. Turn off  $V_G$  supply



## Evaluation Board (EVB) Layout Assembly

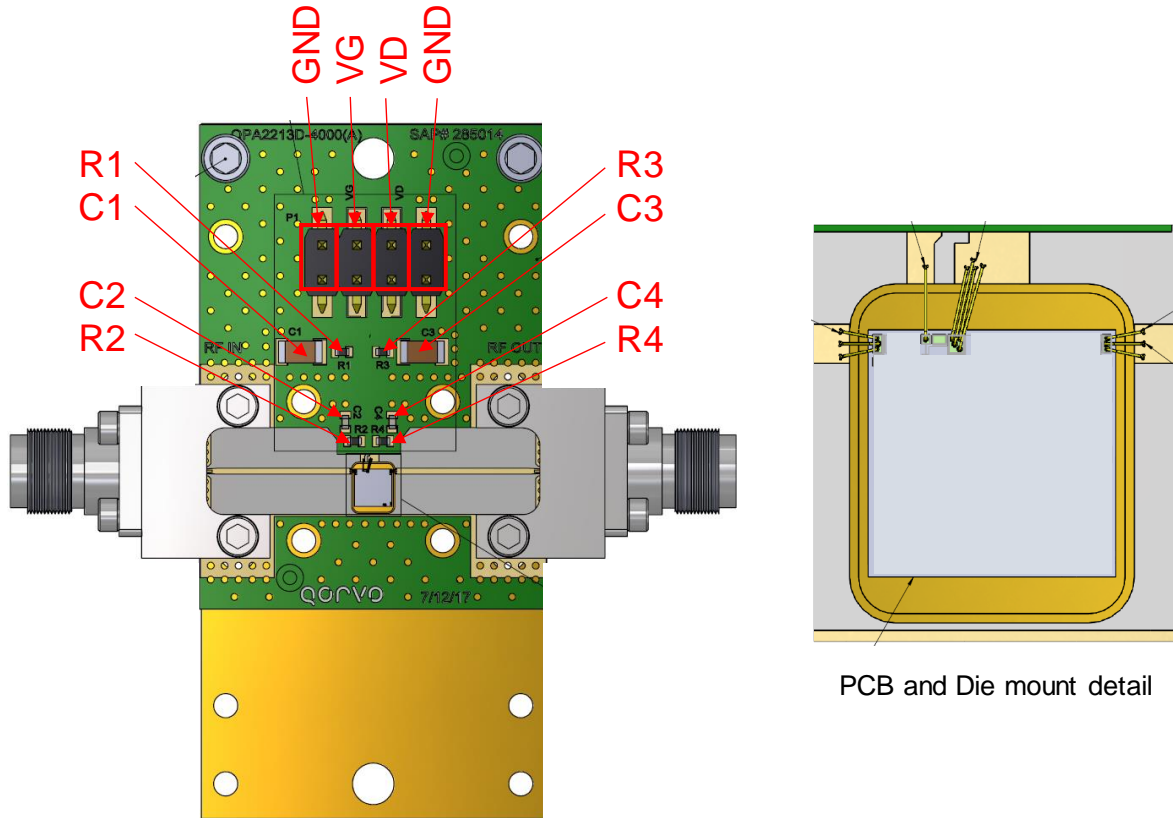

PCB is made from Rogers 4003C dielectric, .008 inch thick, 0.5 oz. copper both sides.  
 Carrier plate has a raised pedestal to contact the back of the die.

## Bill of Materials

Reference Des.	Value	Description	Manuf.	Part Number
C1, C3	10 uF	CAP, 10 uF, 20%, 50 V, 20%, X5R, 1206	Various	
C2, C4	0.01 uF	CAP, 0.01 uF, 10%, 50 V, X7R, 0402	Various	
R1	5.1 Ω	RES, 5.1 OHM, 5%, 50 V, 0402	Various	
R2, R3, R4	0 Ω	RES, 0 OHM, JMPR, 0402	Various	
J1, J2	2.92 mm	CONNECTOR, FEMALE, ENDLAUNCH	Southwest Microwave	1092-01A-5

Mechanical Information

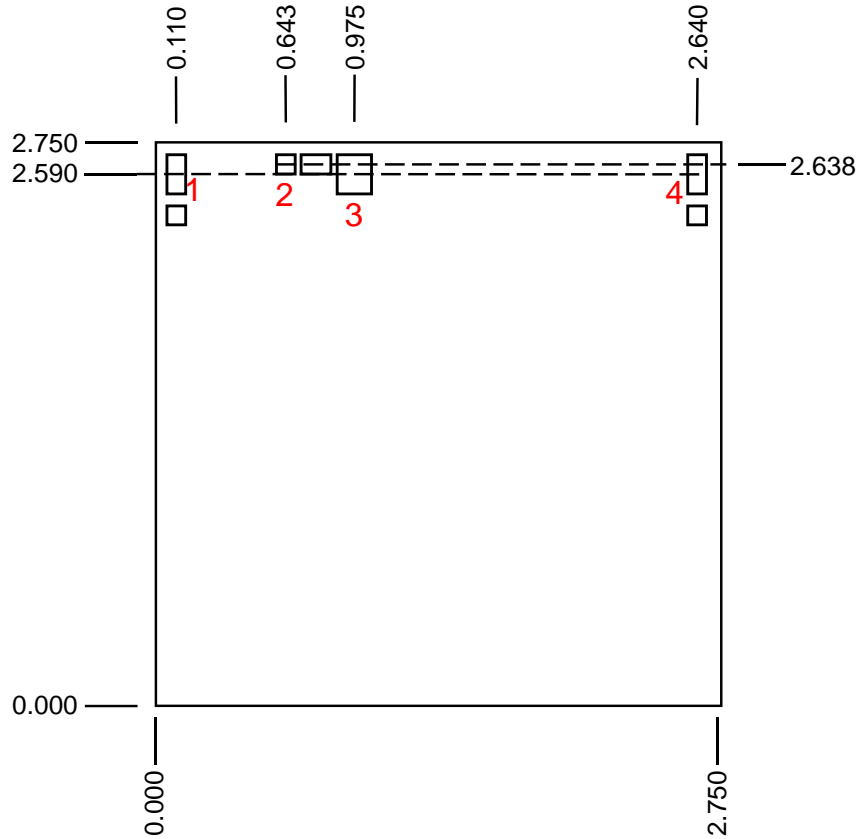

Dimensions are in mm  
Thickness: 0.100  
Die x, y size tolerance: ± 0.050  
Ground is backside of die

Bond Pad Description

Pad No.	Symbol	Pad Size (um)	Description
1	RF IN	90 x 190	RF input. 50 Ohms. DC blocked.
2	VG	90 x 93.5	Gate voltage. Bypass network required; refer to page 24.
3	VD	165 x 193.5	Drain voltage. Bypass network required; refer to page 24.
4	RF OUT	90 x 190	RF output. 50 Ohms. DC blocked.

## Assembly Notes

---

Component placement and adhesive attachment assembly notes:

- Vacuum pencils and/or vacuum collets are the preferred method of pick up.
- Air bridges must be avoided during placement.
- The force impact is critical during auto placement.

Reflow process assembly notes:

- Use AuSn (80/20) solder and limit exposure to temperatures above 300 °C to 3–4 minutes, maximum.
- An alloy station or conveyor furnace with reducing atmosphere should be used.
- Do not use any kind of flux.
- Coefficient of thermal expansion matching is critical for long-term reliability.
- Devices must be stored in a dry nitrogen atmosphere.

Interconnect process assembly notes:

- Thermosonic ball bonding is the preferred interconnect technique.
- Force, time, and ultrasonic are critical parameters.
- Aluminum wire should not be used.
- Devices with small pad sizes should be bonded with 0.0007-inch wire.

## Handling Precautions

Parameter	Rating	Standard
ESD – Human Body Model (HBM)	1A	ANSI/ESD/JEDEC JS-001



Caution!  
ESD-Sensitive Device

## Solderability

Use only AuSn (80/20) solder, and limit exposure to temperatures above 300 °C to 3–4 minutes, maximum.

## RoHS Compliance

This part is compliant with 2011/65/EU RoHS directive (Restrictions on the Use of Certain Hazardous Substances in Electrical and Electronic Equipment) as amended by Directive 2015/863/EU.

This product also has the following attributes:

- Lead Free
- Halogen Free (Chlorine, Bromine)
- Antimony Free
- TBBP-A (C<sub>15</sub>H<sub>12</sub>Br<sub>4</sub>O<sub>2</sub>) Free
- PFOS Free
- SVHC Free

## Contact Information

For the latest specifications, additional product information, worldwide sales and distribution locations:

Web: [www.qorvo.com](http://www.qorvo.com)

Tel: 1-844-890-8163

Email: [customer.support@qorvo.com](mailto:customer.support@qorvo.com)

## Important Notice

The information contained herein is believed to be reliable; however, Qorvo makes no warranties regarding the information contained herein and assumes no responsibility or liability whatsoever for the use of the information contained herein. All information contained herein is subject to change without notice. Customers should obtain and verify the latest relevant information before placing orders for Qorvo products. The information contained herein or any use of such information does not grant, explicitly or implicitly, to any party any patent rights, licenses, or any other intellectual property rights, whether with regard to such information itself or anything described by such information. **THIS INFORMATION DOES NOT CONSTITUTE A WARRANTY WITH RESPECT TO THE PRODUCTS DESCRIBED HEREIN, AND QORVO HEREBY DISCLAIMS ANY AND ALL WARRANTIES WITH RESPECT TO SUCH PRODUCTS WHETHER EXPRESS OR IMPLIED BY LAW, COURSE OF DEALING, COURSE OF PERFORMANCE, USAGE OF TRADE OR OTHERWISE, INCLUDING THE IMPLIED WARRANTIES OF MERCHANTABILITY AND FITNESS FOR A PARTICULAR PURPOSE.**

Without limiting the generality of the foregoing, Qorvo products are not warranted or authorized for use as critical components in medical, life-saving, or life-sustaining applications, or other applications where a failure would reasonably be expected to cause severe personal injury or death.

© 2021 Qorvo US, Inc. All rights reserved. This document is subject to copyright laws in various jurisdictions worldwide and may not be reproduced or distributed, in whole or in part, without the express written consent of Qorvo US, Inc.

## X-ON Electronics

Largest Supplier of Electrical and Electronic Components

*Click to view similar products for [RF Amplifier](#) category:*

*Click to view products by [Qorvo](#) manufacturer:*

Other Similar products are found below :

[A82-1](#) [BGA622H6820XTSA1](#) [BGA 728L7 E6327](#) [BGB719N7ESDE6327XTMA1](#) [HMC397-SX](#) [HMC405](#) [HMC561-SX](#) [HMC8120-SX](#)  
[HMC8121-SX](#) [HMC-ALH382-SX](#) [HMC-ALH476-SX](#) [SE2433T-R](#) [SMA3101-TL-E](#) [SMA39](#) [A66-1](#) [A66-3](#) [A67-1](#) [LX5535LQ](#) [LX5540LL](#)  
[MAAM02350](#) [HMC3653LP3BETR](#) [HMC549MS8GETR](#) [HMC-ALH435-SX](#) [SMA101](#) [SMA32](#) [SMA411](#) [SMA531](#) [SST12LP19E-QX6E](#)  
[WPM0510A](#) [HMC5929LS6TR](#) [HMC5879LS7TR](#) [HMC1126](#) [HMC1087F10](#) [HMC1086](#) [HMC1016](#) [SMA1212](#) [MAX2689EWS+T](#)  
[MAAMSS0041TR](#) [MAAM37000-A1G](#) [LTC6430AIUF-15#PBF](#) [CHA5115-QDG](#) [SMA70-2](#) [SMA4011](#) [A231](#) [HMC-AUH232](#) [LX5511LQ](#)  
[LX5511LQ-TR](#) [HMC7441-SX](#) [HMC-ALH310](#) [XD1001-BD-000V](#)