

Product Overview

Qorvo’s QPA2213 is a packaged wide band driver amplifier fabricated on Qorvo’s production 0.15 um GaN on SiC process (QGaN15). Covering 2.0–20.0 GHz, the QPA2213 provides > 2 W of saturated output power and 16 dB of large-signal gain while achieving > 23% power-added efficiency.

The QPA2213 is packaged in a 4.5 x 4.5 mm laminate package. It can support a variety of operating conditions to best support system requirements. With good thermal properties, it can support a range of bias voltages.

The QPA2213 has DC blocking capacitors on both RF ports, which are matched to 50 ohms. The QPA2213 is ideal for both commercial and military wide band or narrow band systems.

Lead-free and RoHS compliant.

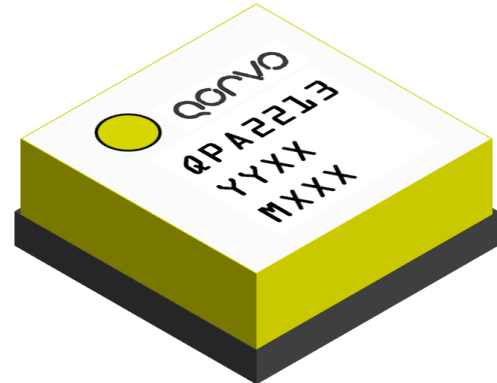

Key Features

- Frequency Range: 2–20 GHz
- P_{SAT} ($P_{IN}=18$ dBm): 34 dBm
- PAE ($P_{IN}=18$ dBm): 23 %
- Power Gain ($P_{IN}=18$ dBm): 16 dB
- Small Signal Gain: 25 dB
- Noise Figure: 4.0 dB
- Bias: $V_D = 18$ V, $I_{DQ} = 330$ mA, $P_{IN} = 18$ dBm
- Package Dimensions: 4.50 x 4.50 x 1.74 mm

Performance is typical across frequency. Please reference electrical specification table and data plots for more details.

Functional Block Diagram

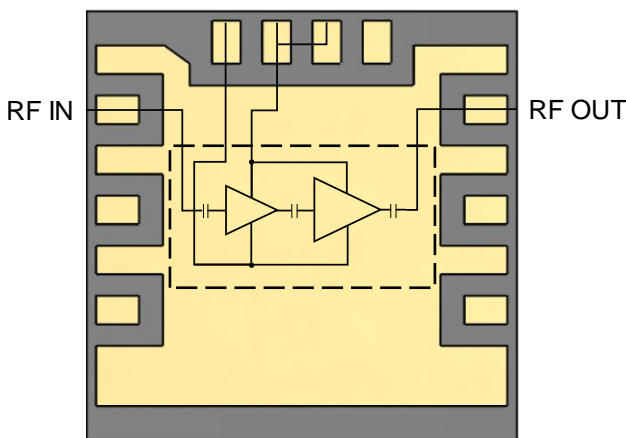

Top View

Applications

- HPA Driver Amplifier
- Radar Systems

Ordering Information

| Part No. | Description |
|---------------|--|
| QPA2213 | 2 –20 GHz 2 Watt GaN Amplifier (10 Pcs.) |
| QPA2213S2 | Samples (2 pcs.) |
| QPA2213EVBV01 | Evaluation Board for QPA2213 |

Absolute Maximum Ratings

| Parameter | Value / Range |
|---|-----------------|
| Drain Voltage (V_D) | 29.5 V |
| Gate Voltage Range (V_G) | -4 V to 0 V |
| Drain Current (I_D) | 890 mA |
| Gate Current (I_G) | See plot pg. 23 |
| Power Dissipation (P_{DISS}), 85 °C | 13.7 W |
| Input Power (P_{IN}), 50 Ω , $V_D=18$ V, $I_{DQ}=330$ mA, 85 °C | 27 dBm |
| Input Power (P_{IN}), 3:1 VSWR, $V_D=18$ V, $I_{DQ}=330$ mA, 85 °C | 27 dBm |
| Soldering Temperature | 260 °C |
| Storage Temperature | -55 to +125 °C |

Operation of this device outside the parameter ranges given above may cause permanent damage. These are stress ratings only, and functional operation of the device at these conditions is not implied.

Recommended Operating Conditions

| Parameter | Value / Range |
|----------------------------|---------------|
| Drain Voltage (V_D) | 18 V |
| Drain Current (I_{DQ}) | 330 mA |
| Operating Temperature | -40 to +85 °C |

Electrical specifications are measured at specified test conditions. Specifications are not guaranteed over all recommended operating conditions.

Electrical Specifications

| Parameter | | Min | Typ | Max | Units |
|---|--------|-----|--------|-----|-------|
| Operational Frequency | | 2 | | 20 | GHz |
| Output Power (P _{IN} =18 dBm) | 2 GHz | | 34.2 | | dBm |
| | 6 GHz | | 35.5 | | dBm |
| | 10 GHz | | 34.2 | | dBm |
| | 15 GHz | | 34.0 | | dBm |
| | 20 GHz | | 33.3 | | dBm |
| Power Added Efficiency (P _{IN} =18 dBm) | 2 GHz | | 36.9 | | % |
| | 6 GHz | | 22.5 | | % |
| | 10 GHz | | 23.6 | | % |
| | 15 GHz | | 21.5 | | % |
| | 20 GHz | | 20.4 | | % |
| Small Signal Gain | 2 GHz | | 25.3 | | dB |
| | 6 GHz | | 26.0 | | dB |
| | 10 GHz | | 24.8 | | dB |
| | 15 GHz | | 22.9 | | dB |
| | 20 GHz | | 21.4 | | dB |
| Input Return Loss | 2 GHz | | 18 | | dB |
| | 6 GHz | | 16 | | dB |
| | 10 GHz | | 12 | | dB |
| | 15 GHz | | 14 | | dB |
| | 20 GHz | | 29 | | dB |
| Output Return Loss | 2 GHz | | 7 | | dB |
| | 6 GHz | | 15 | | dB |
| | 10 GHz | | 19 | | dB |
| | 15 GHz | | 19 | | dB |
| | 20 GHz | | 26 | | dB |
| Noise Figure | 2 GHz | | 7.6 | | dB |
| | 6 GHz | | 4.4 | | dB |
| | 10 GHz | | 3.2 | | dB |
| | 15 GHz | | 4.0 | | dB |
| | 20 GHz | | 5.3 | | dB |
| IMD3 (P _{OUT} /Tone=27 dBm) (100 MHz tone spacing) | 2 GHz | | -23.0 | | dBc |
| | 6 GHz | | -21.7 | | dBc |
| | 10 GHz | | -21.9 | | dBc |
| | 15 GHz | | -21.4 | | dBc |
| | 20 GHz | | -19.8 | | dBc |
| P _{OUT} Temp. Coeff. (85 °C to 25 °C, P _{IN} = 18 dBm)) | | | -0.006 | | dB/°C |
| Sm. Sig. Gain Temp. Coefficient (85 °C to -40 °C) | | | -0.043 | | dB/°C |

Test conditions, unless otherwise noted: T = 25 °C, V_D = 18 V, I_{DQ} = 330 mA

Performance Plots – Small Signal

Test conditions, unless otherwise noted: $V_D = 18\text{ V}$, $I_{DQ} = 330\text{ mA}$, $T = +25\text{ }^\circ\text{C}$

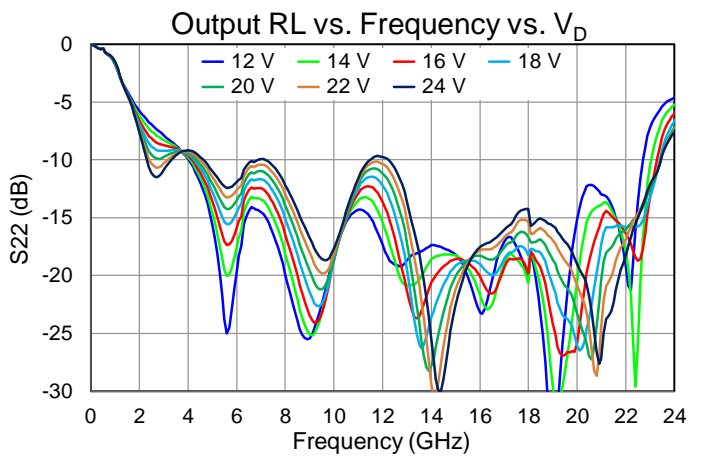
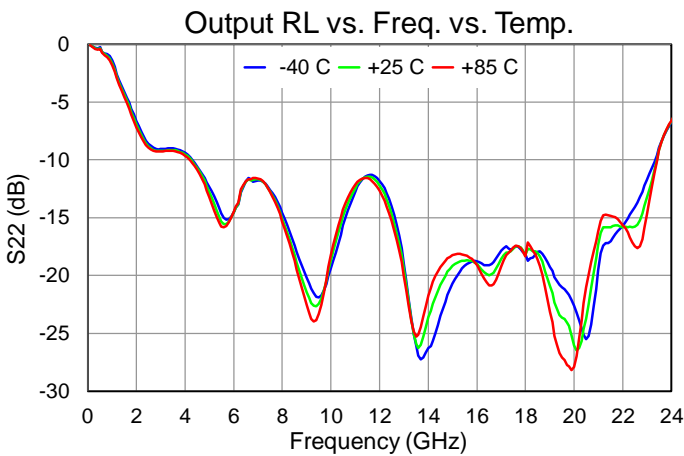
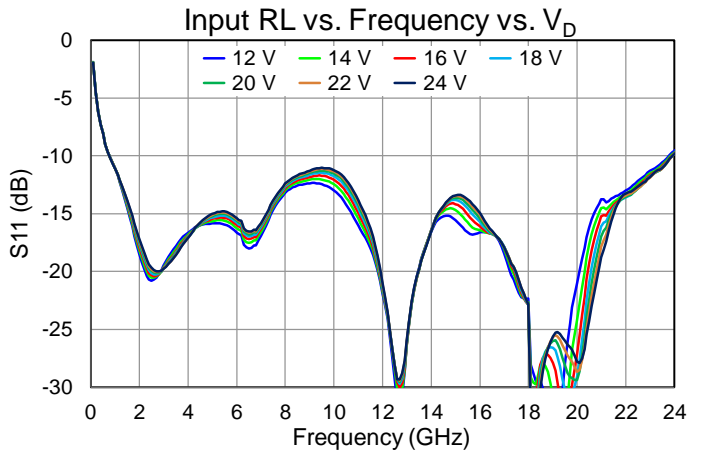
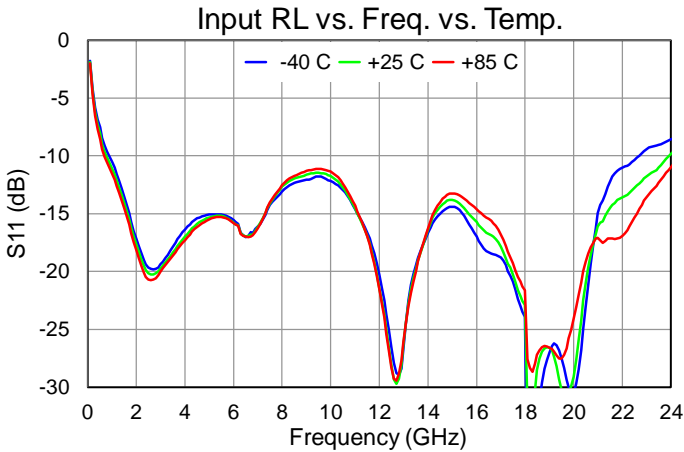
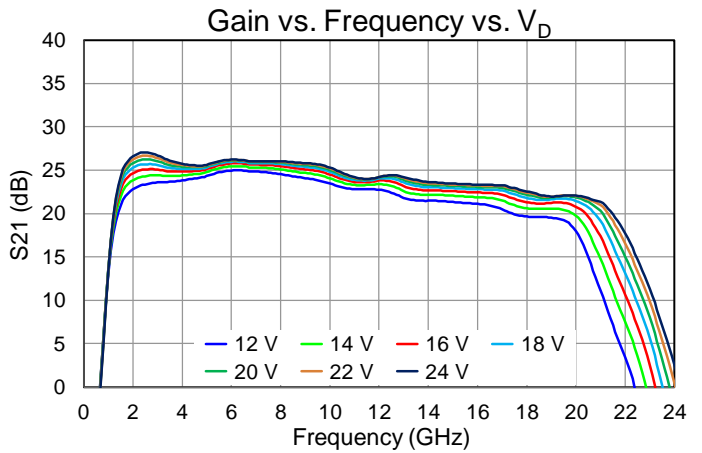
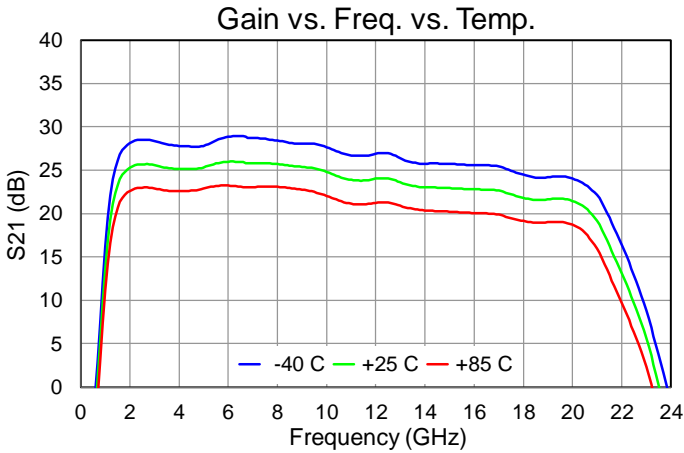

Performance Plots – Small Signal

Test conditions, unless otherwise noted: $V_D = 18\text{ V}$, $I_{DQ} = 330\text{ mA}$, $T = +25\text{ }^\circ\text{C}$

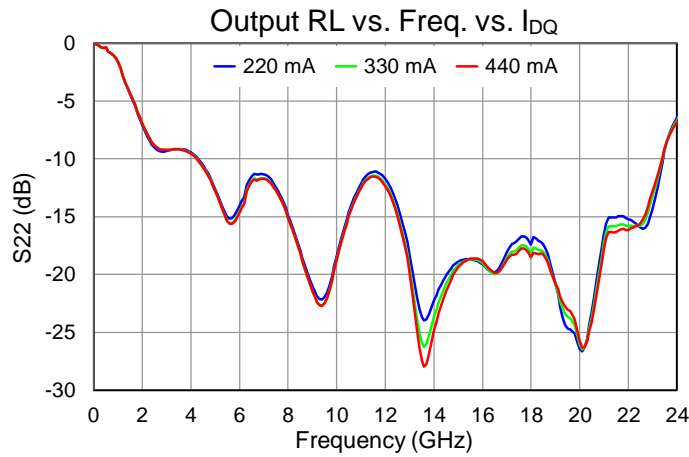
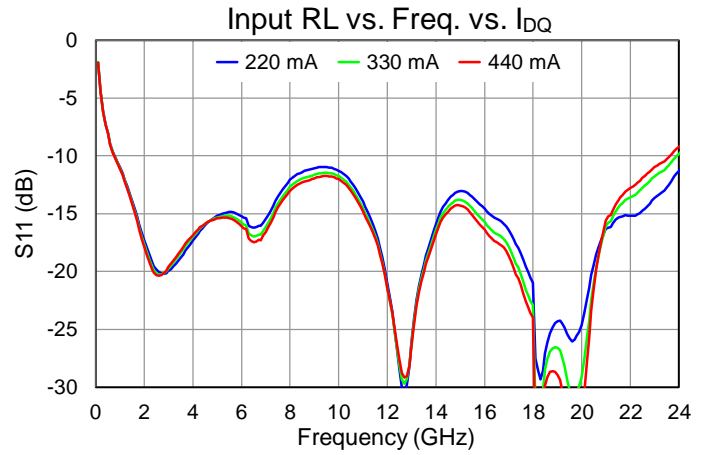
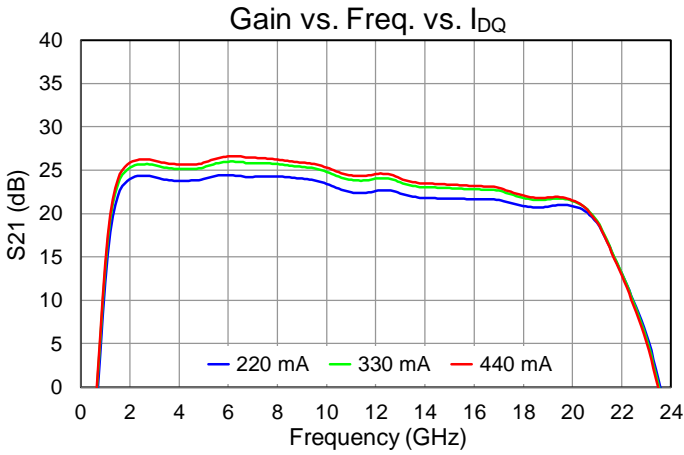

Performance Plots – Noise Figure

Test conditions, unless otherwise noted: $V_D = 18\text{ V}$, $I_{DQ} = 330\text{ mA}$, $T = +25\text{ }^\circ\text{C}$

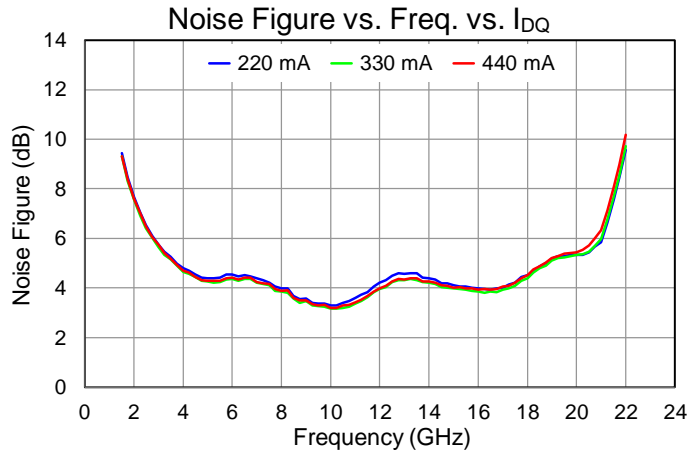
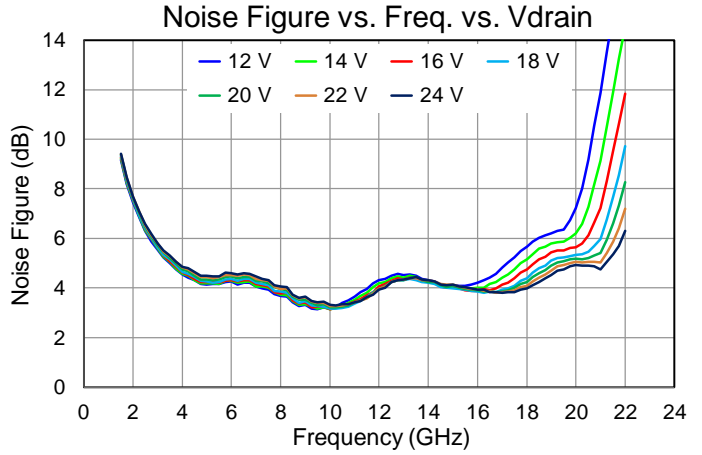
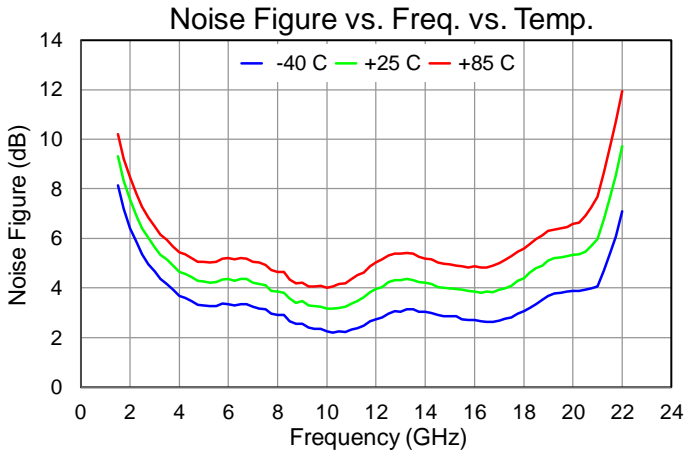

Performance Plots – Large Signal

Test conditions, unless otherwise noted: $V_D = 18\text{ V}$, $I_{DQ} = 330\text{ mA}$, $T = +25\text{ }^\circ\text{C}$, $P_{in} = 18\text{ dBm}$

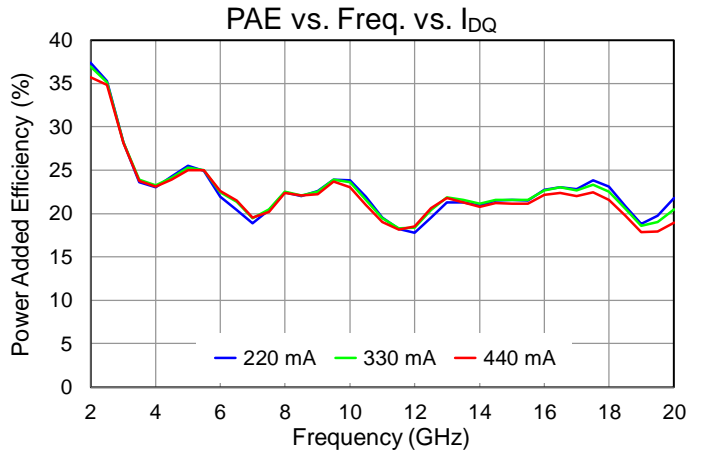
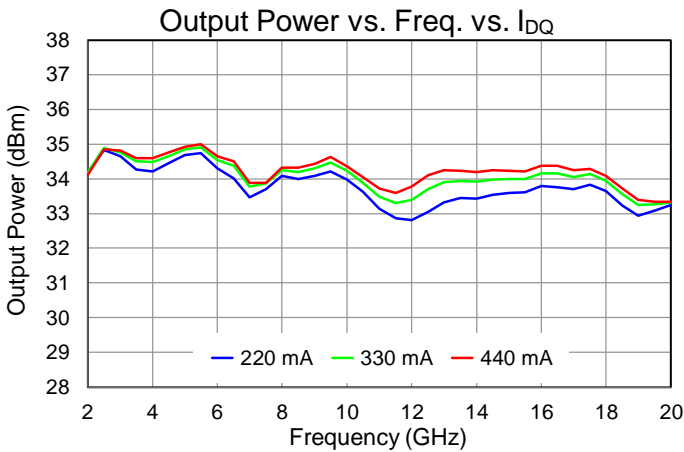
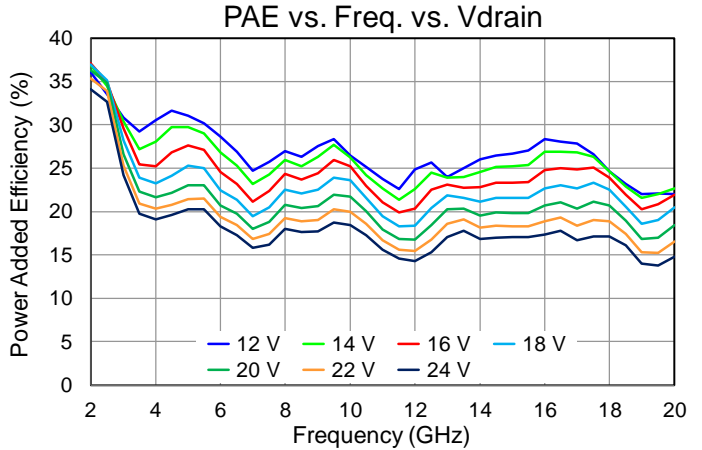
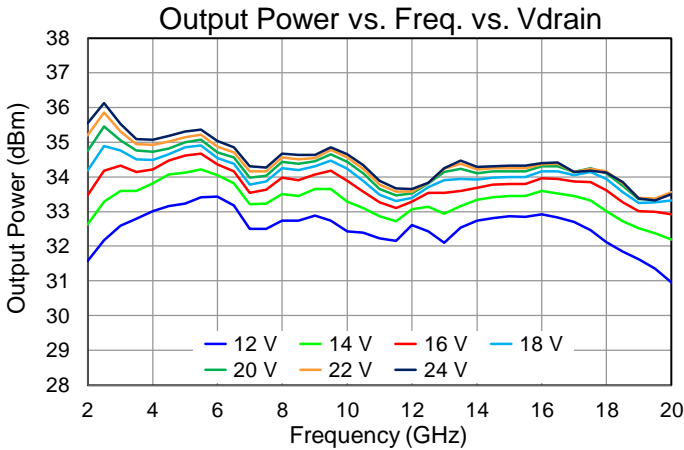
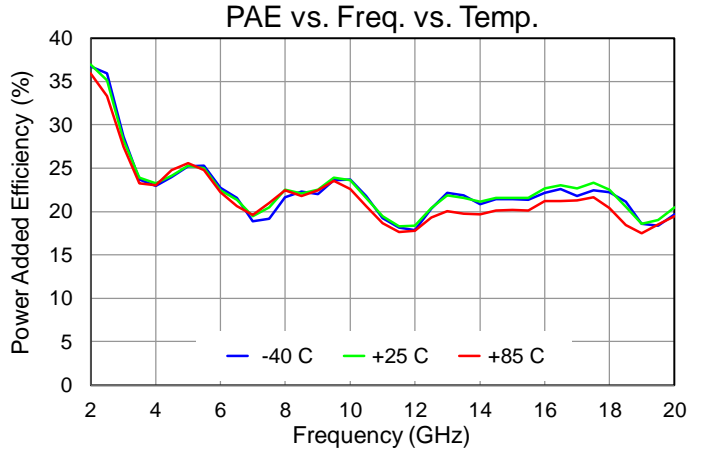
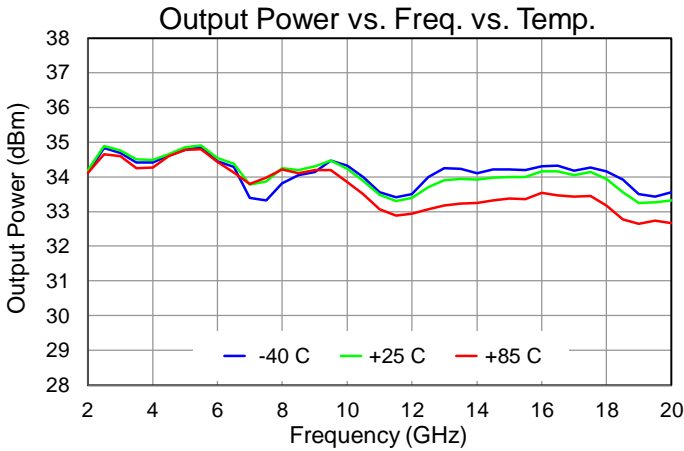

Performance Plots – Large Signal

Test conditions, unless otherwise noted: $V_D = 18\text{ V}$, $I_{DQ} = 330\text{ mA}$, $T = +25\text{ }^\circ\text{C}$, $P_{in} = 18\text{ dBm}$

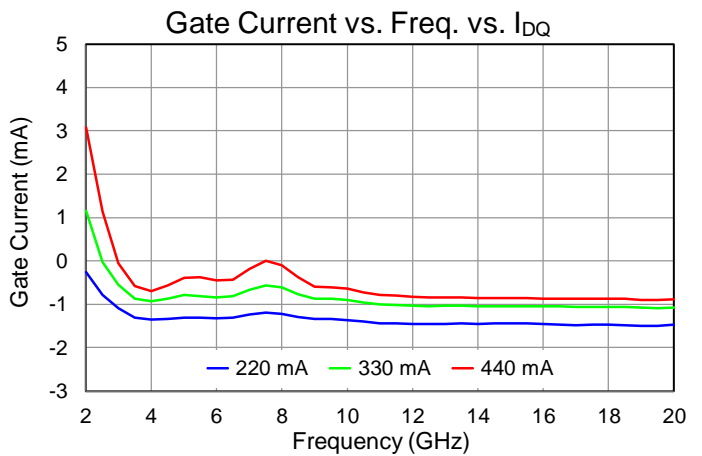
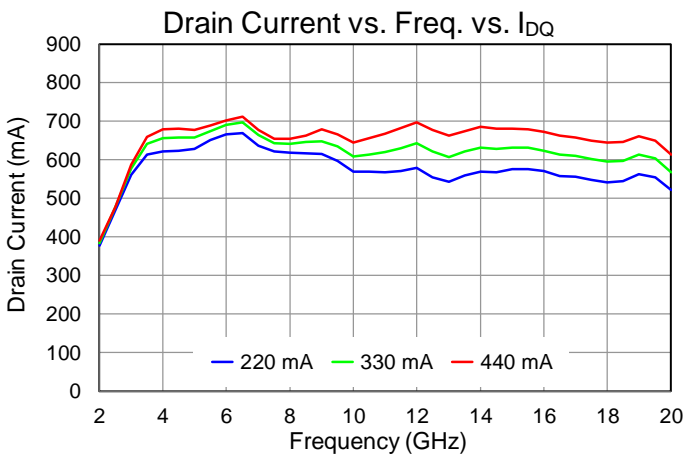
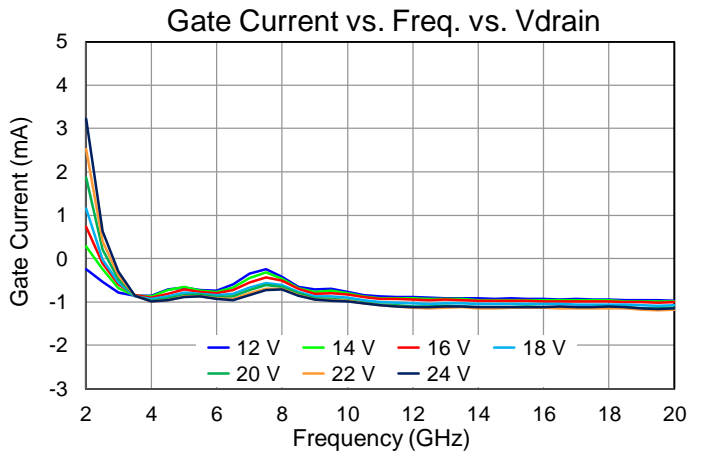
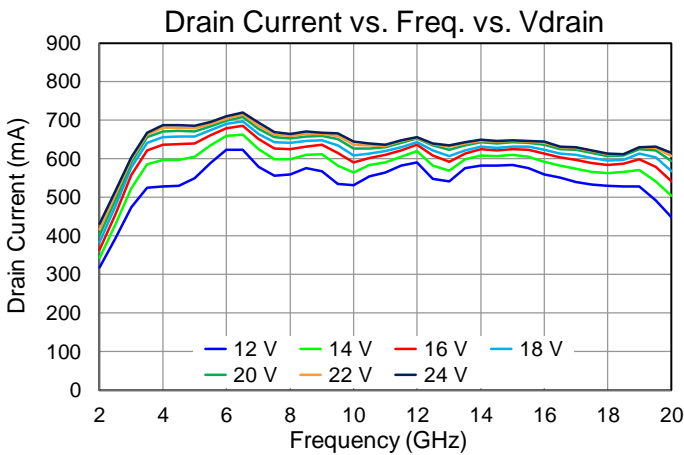
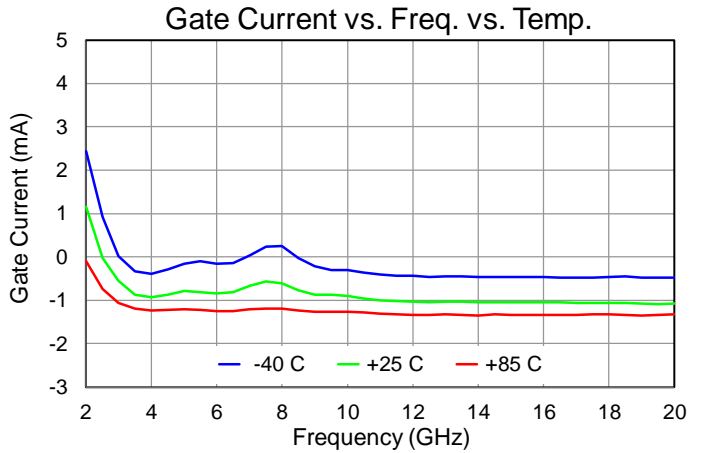
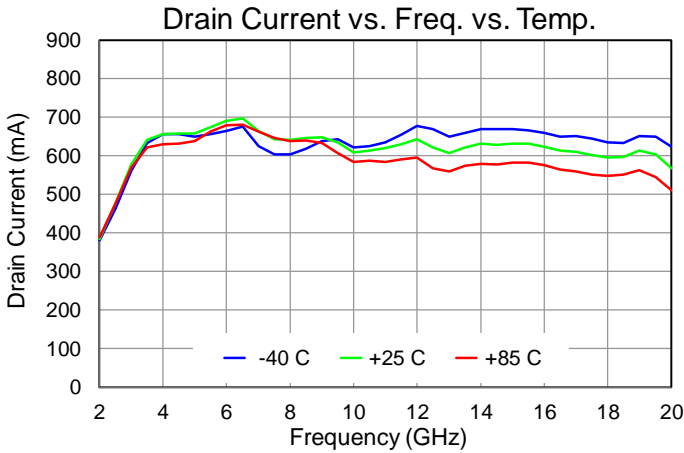

Performance Plots – Large Signal

Test conditions, unless otherwise noted: $V_D = 18\text{ V}$, $I_{DQ} = 330\text{ mA}$, $T = +25\text{ }^\circ\text{C}$

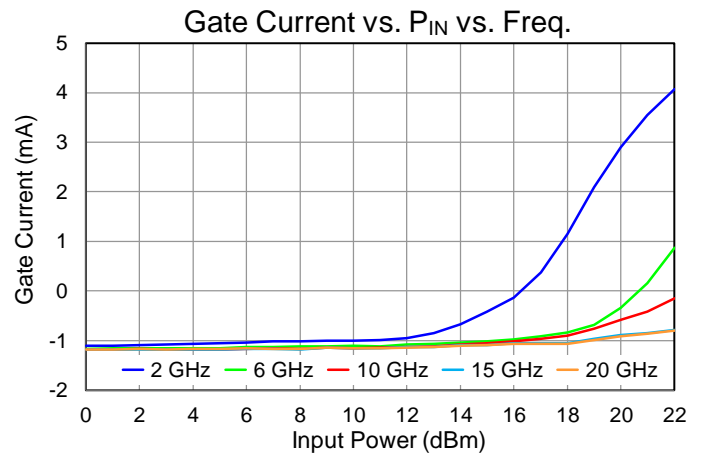
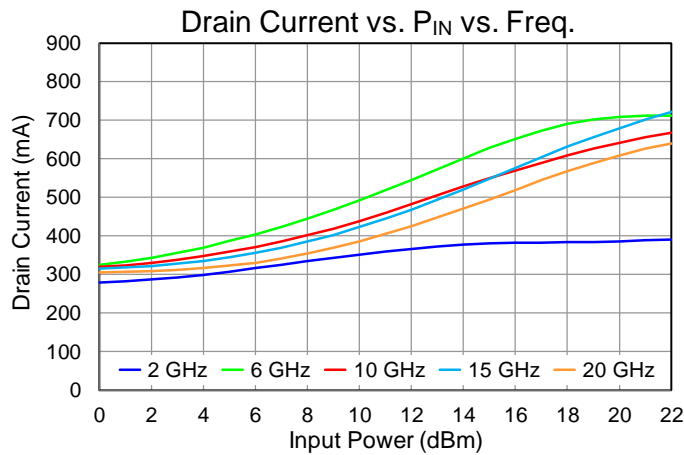
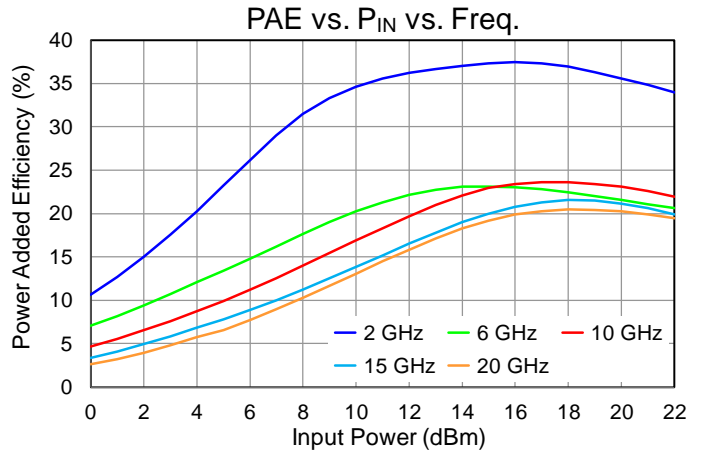
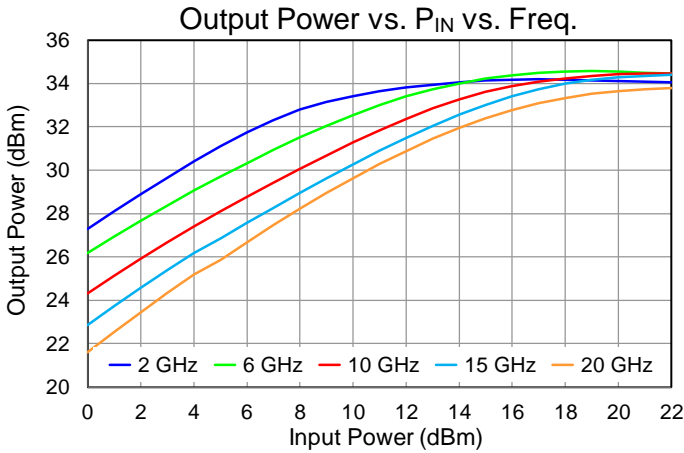

Performance Plots – Large Signal

Test conditions, unless otherwise noted: $V_D = 18\text{ V}$, $I_{DQ} = 330\text{ mA}$, $T = +25\text{ }^\circ\text{C}$

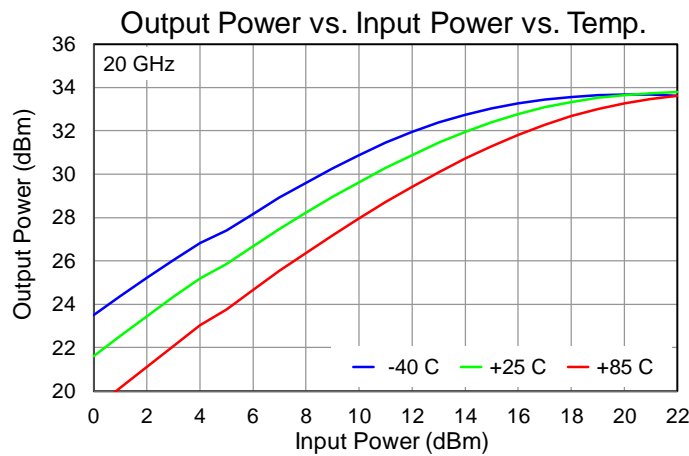
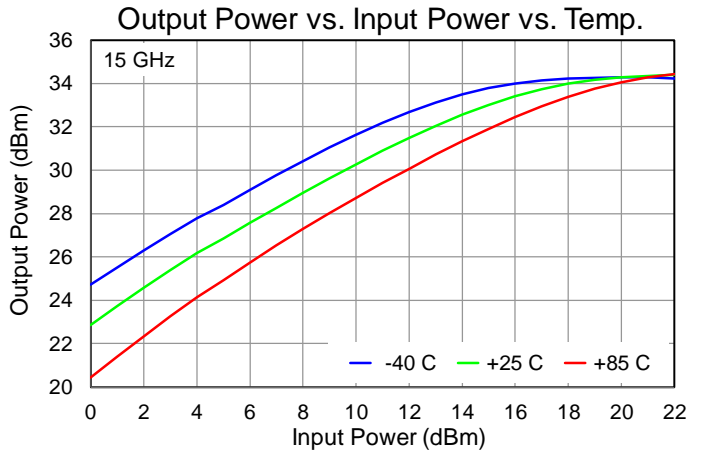
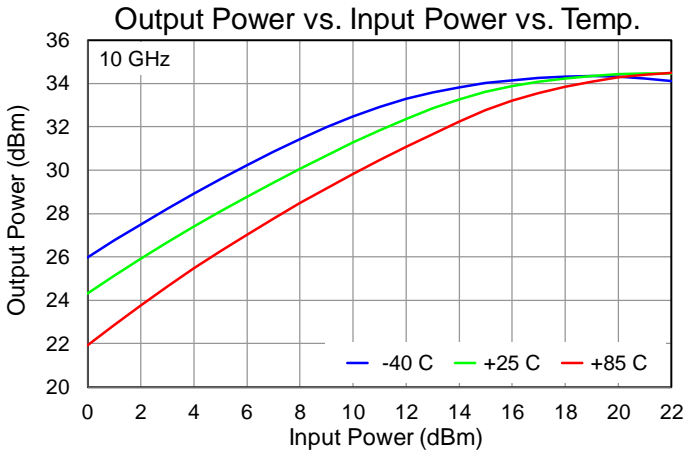
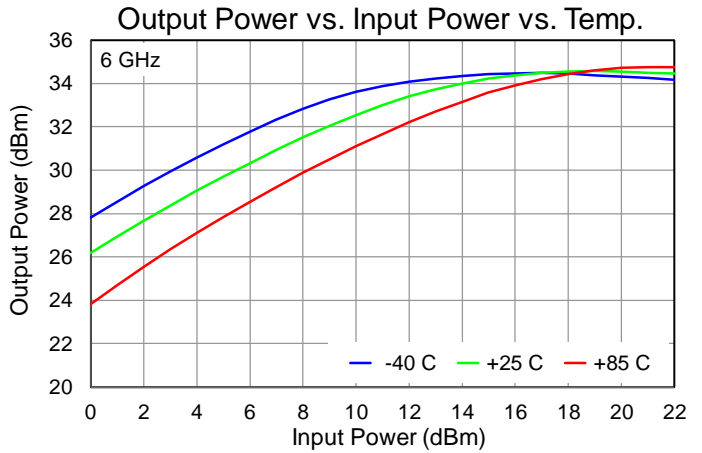
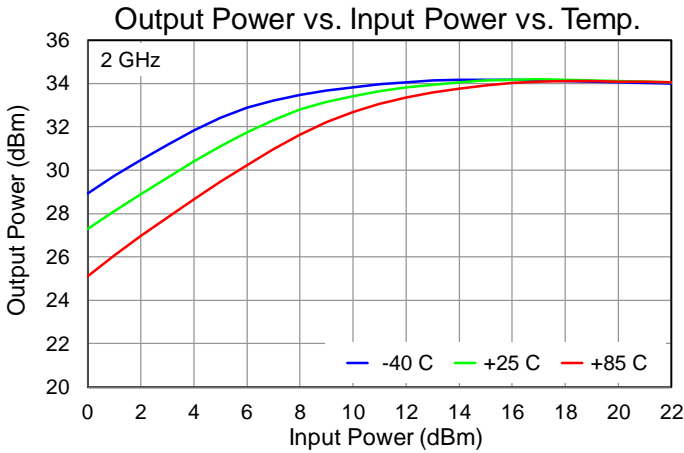

Performance Plots – Large Signal

Test conditions, unless otherwise noted: $V_D = 18\text{ V}$, $I_{DQ} = 330\text{ mA}$, $T = +25\text{ }^\circ\text{C}$

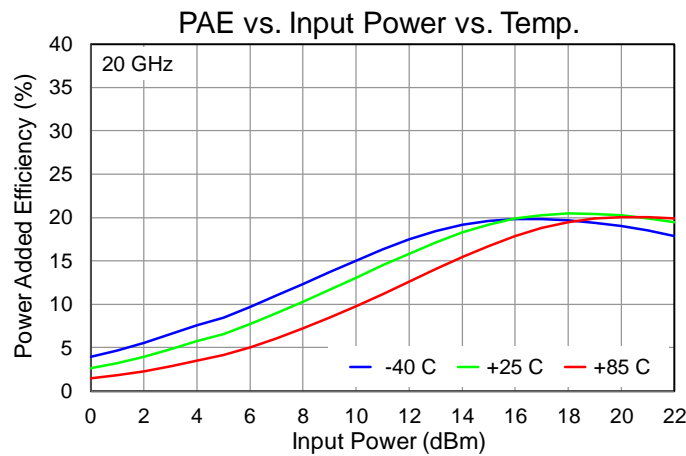
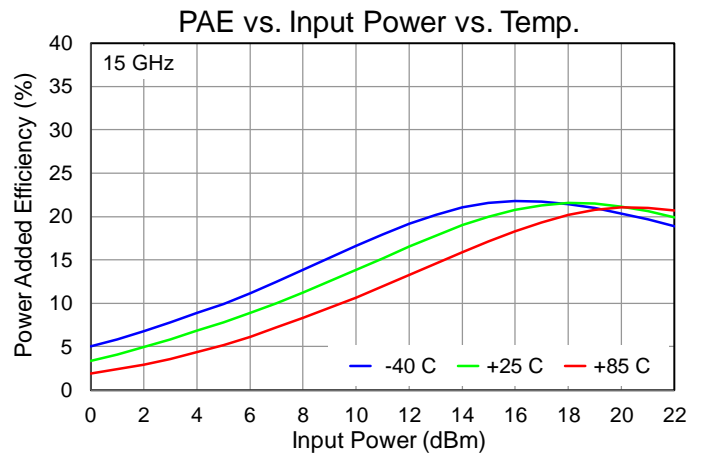
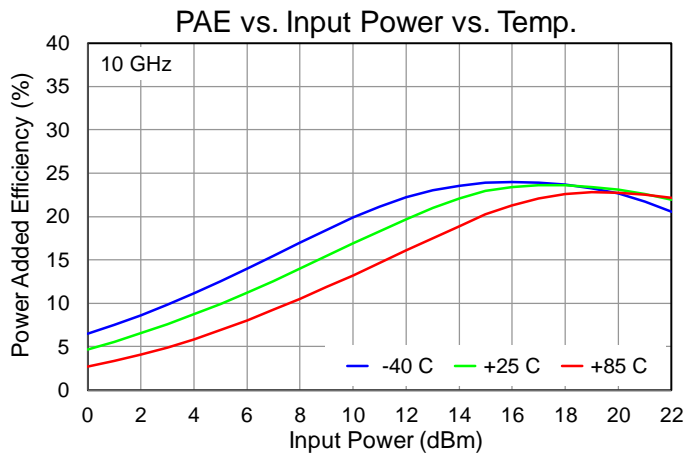
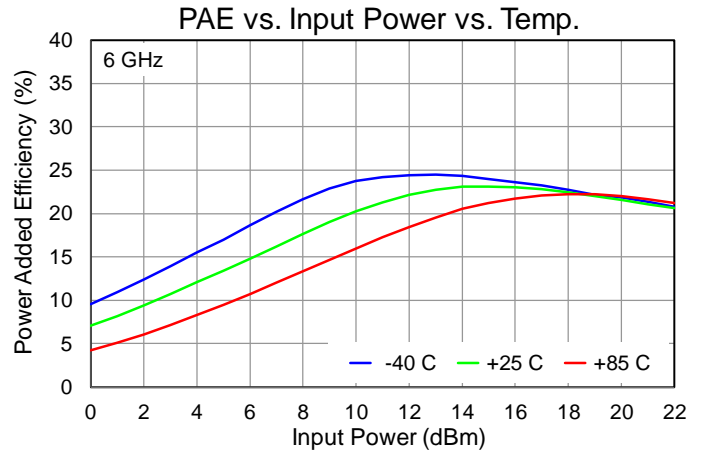
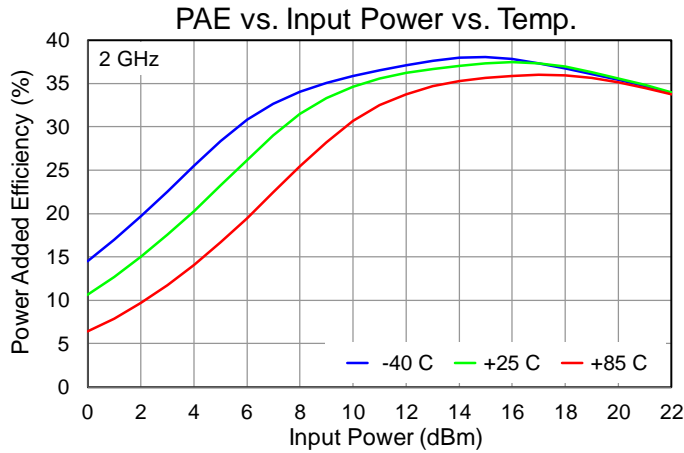

Performance Plots – Large Signal

Test conditions, unless otherwise noted: $V_D = 18\text{ V}$, $I_{DQ} = 330\text{ mA}$, $T = +25\text{ }^\circ\text{C}$

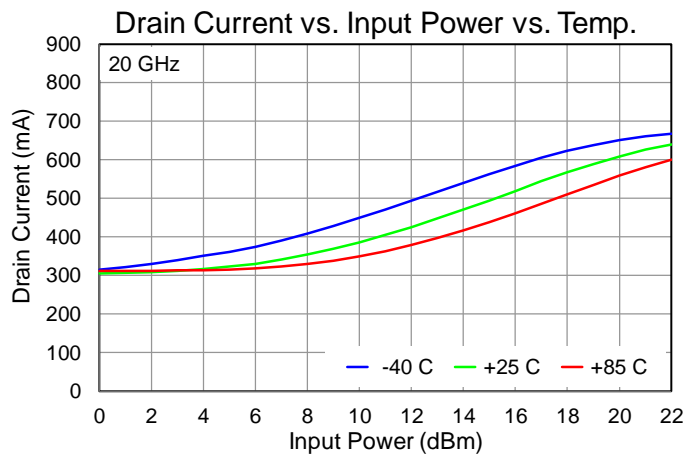
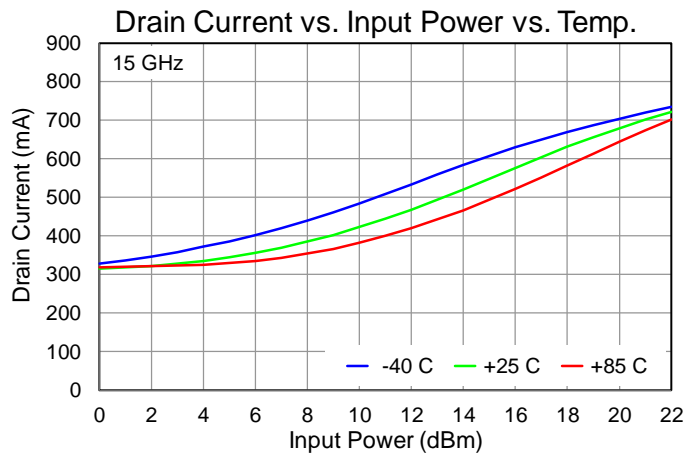
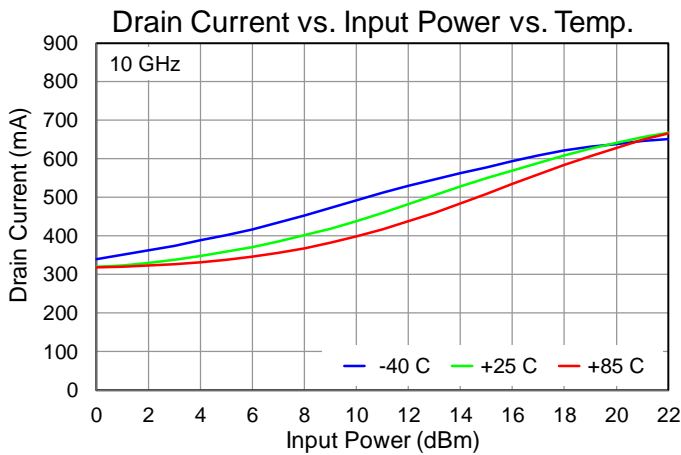
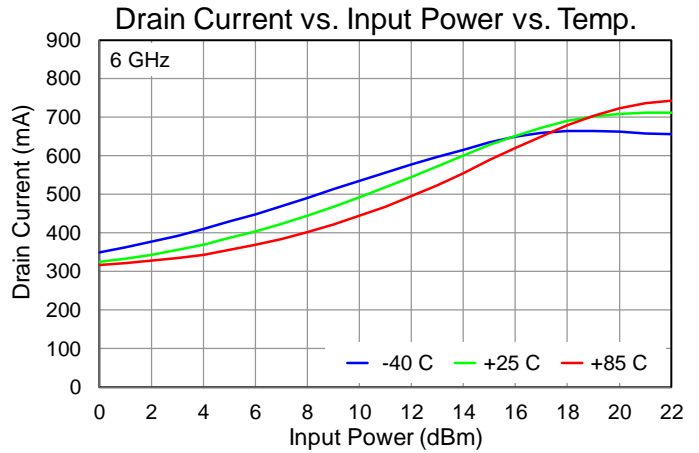
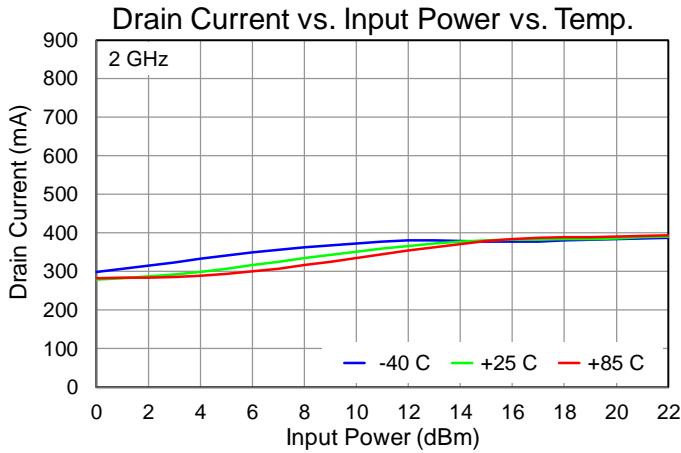

Performance Plots – Large Signal

Test conditions, unless otherwise noted: $V_D = 18\text{ V}$, $I_{DQ} = 330\text{ mA}$, $T = +25\text{ }^\circ\text{C}$

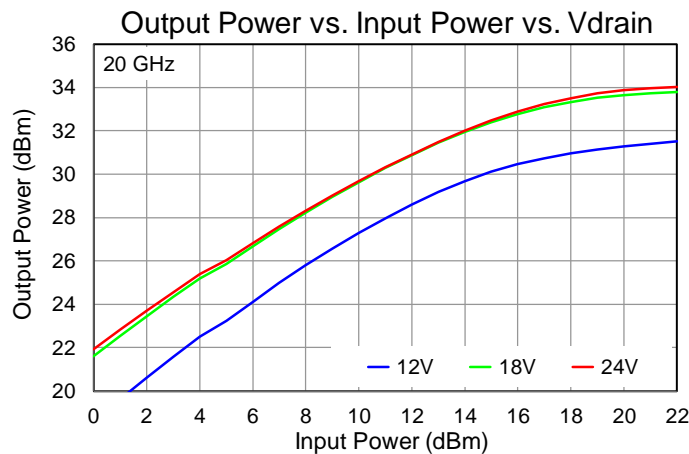
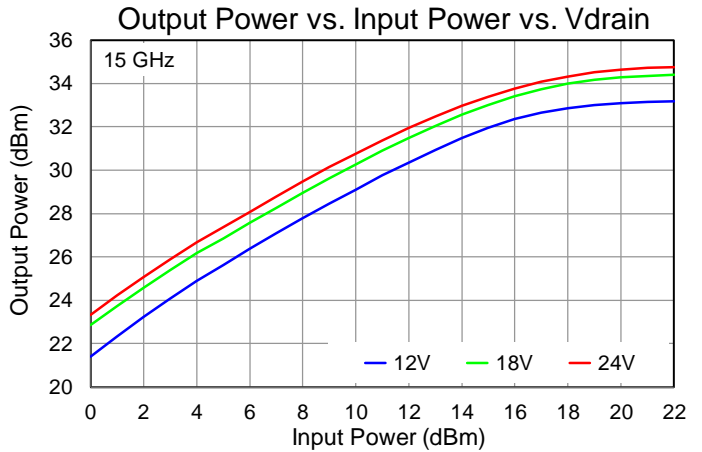
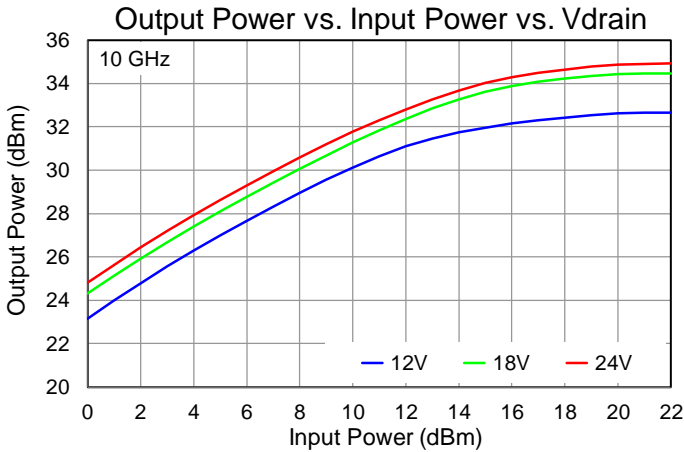
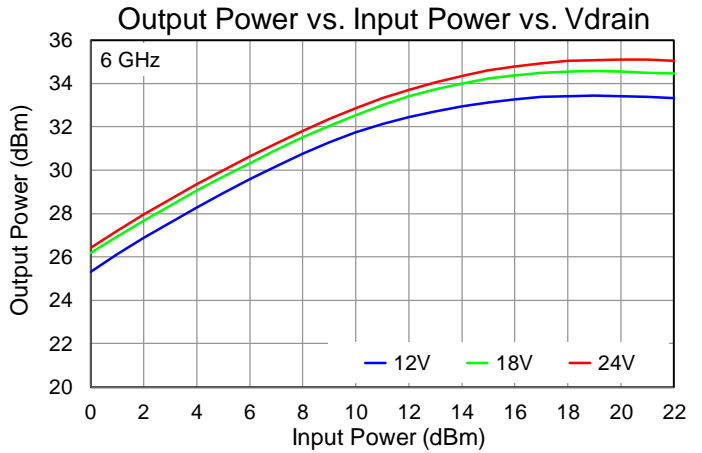
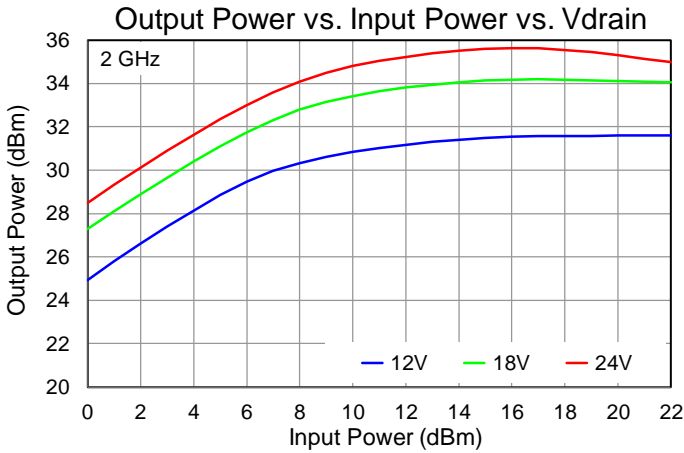

Performance Plots – Large Signal

Test conditions, unless otherwise noted: $V_D = 18\text{ V}$, $I_{DQ} = 330\text{ mA}$, $T = +25\text{ }^\circ\text{C}$

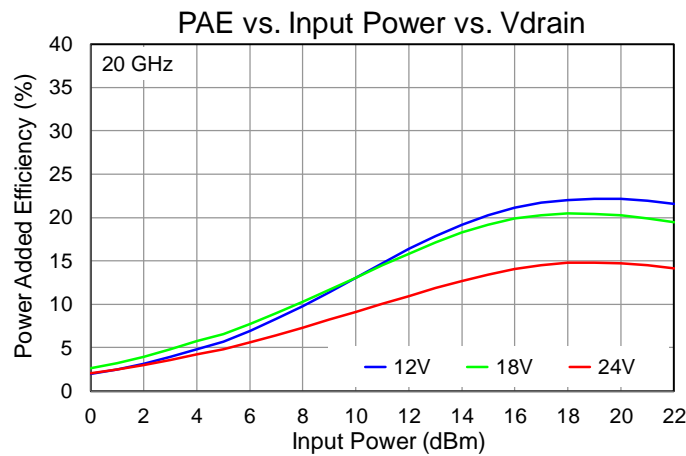
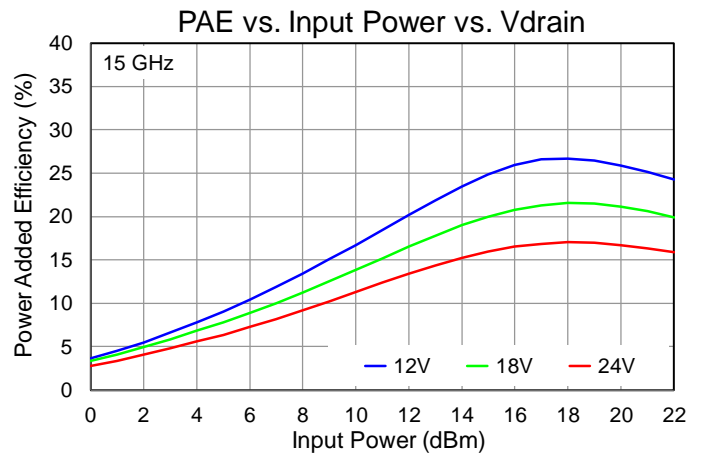
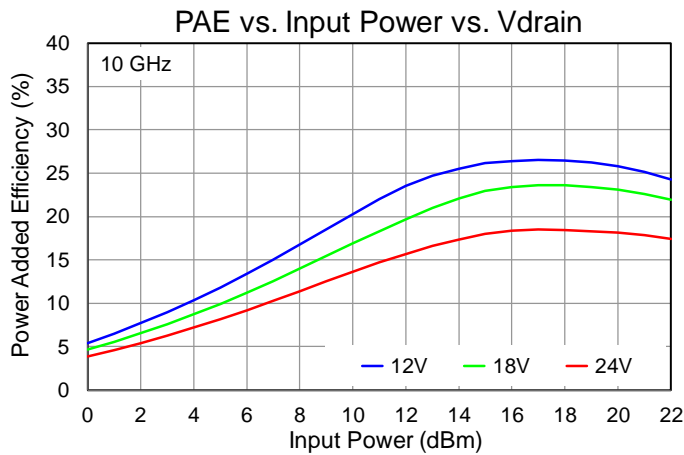
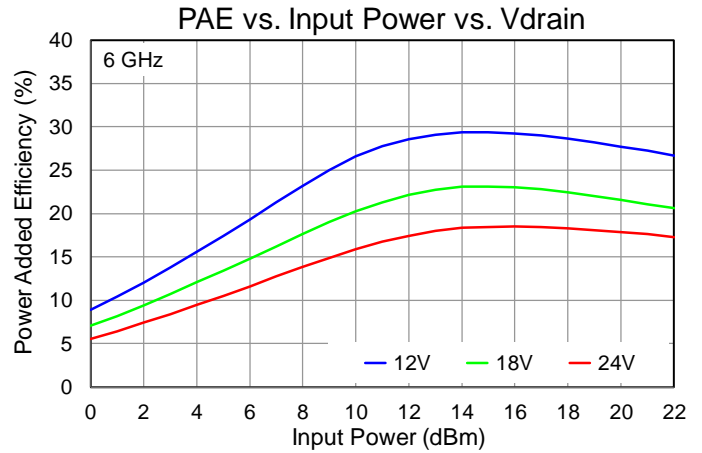
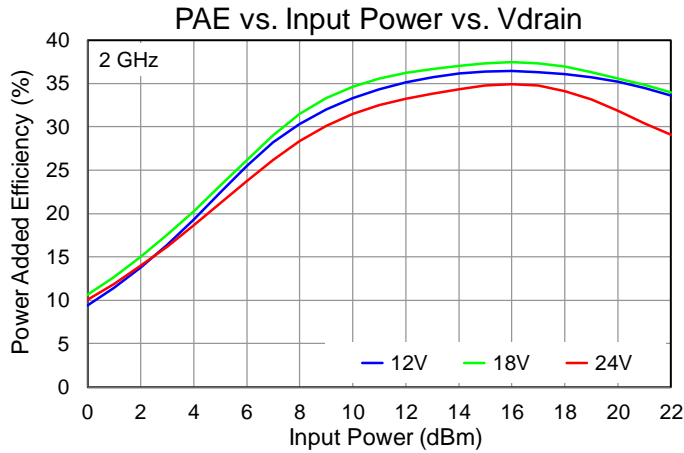

Performance Plots – Large Signal

Test conditions, unless otherwise noted: $V_D = 18\text{ V}$, $I_{DQ} = 330\text{ mA}$, $T = +25\text{ }^\circ\text{C}$

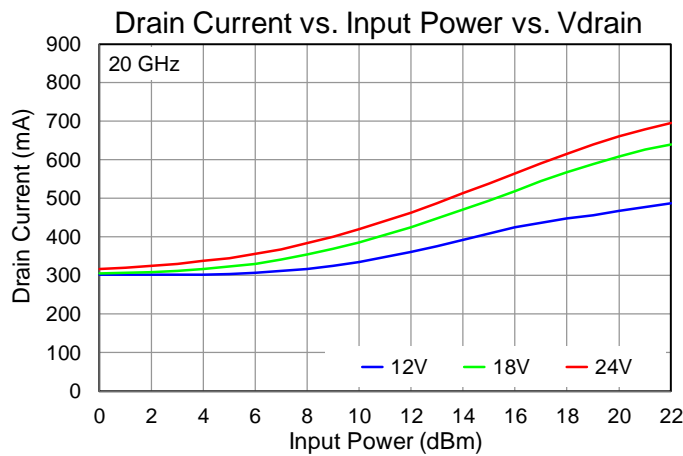
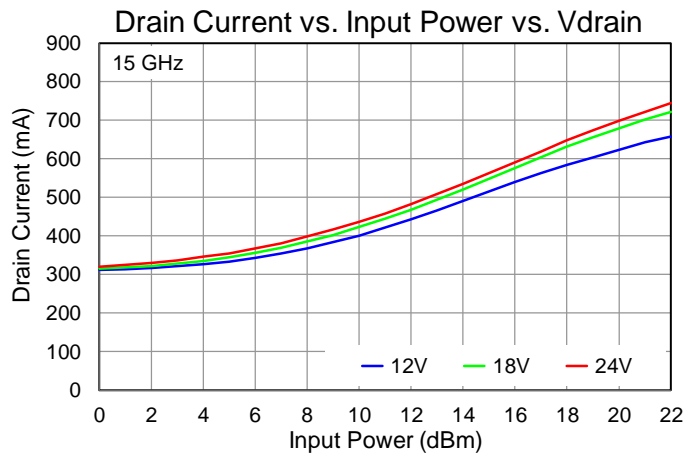
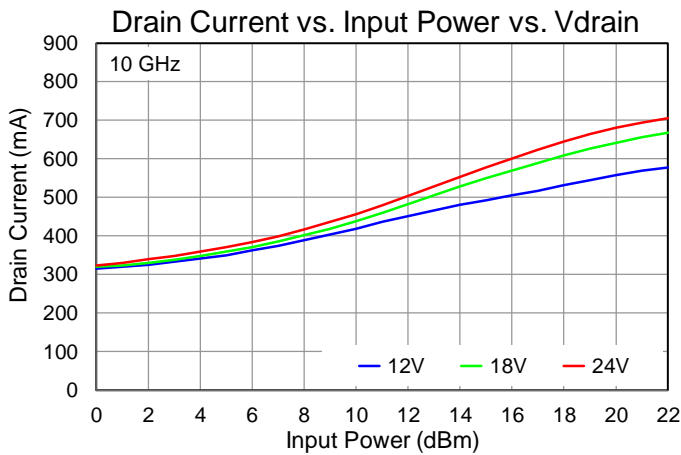
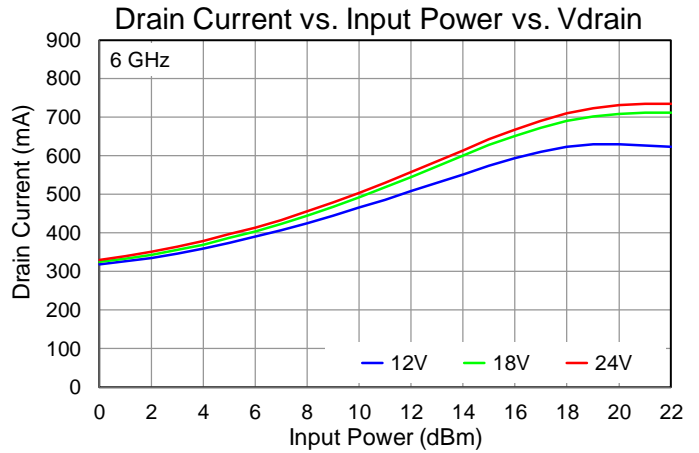
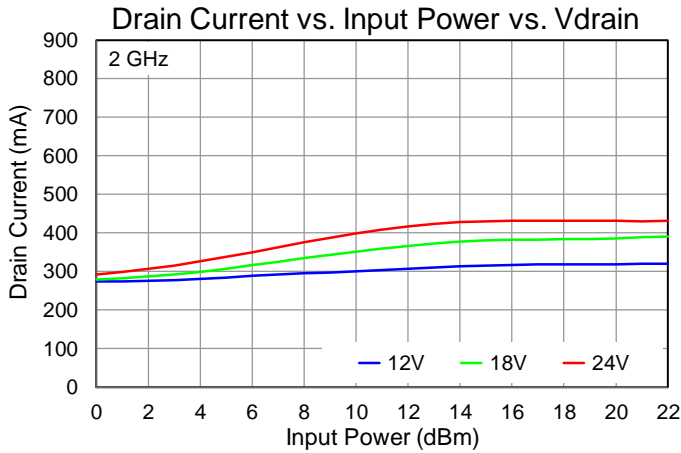

Performance Plots – Large Signal

Test conditions, unless otherwise noted: $V_D = 18\text{ V}$, $I_{DQ} = 330\text{ mA}$, $T = +25\text{ }^\circ\text{C}$

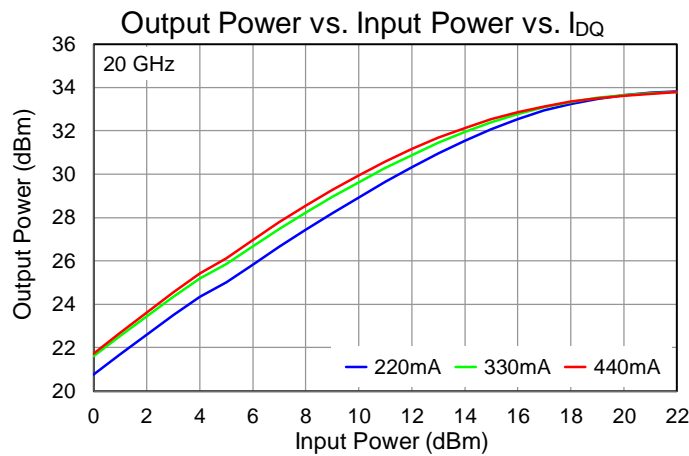
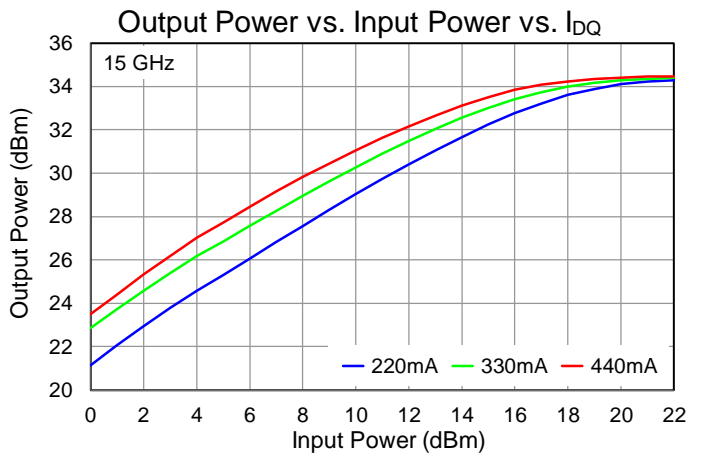
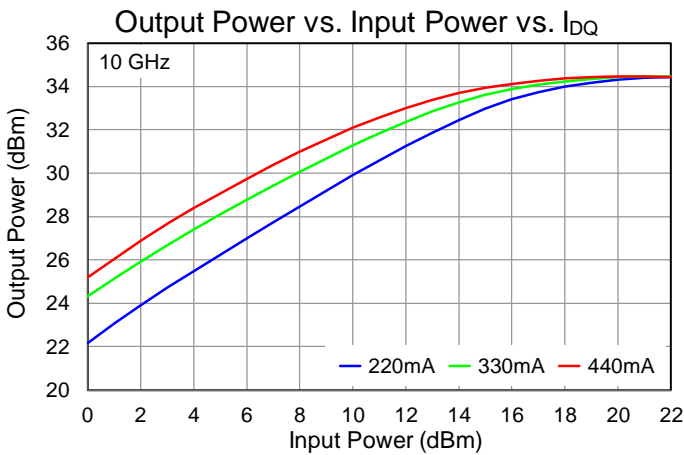
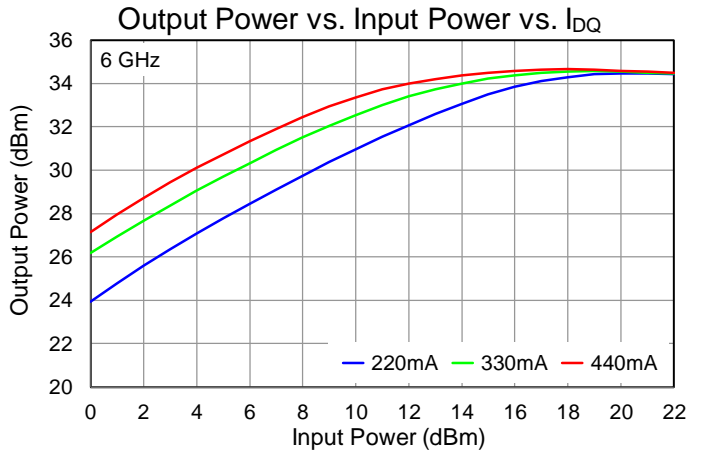
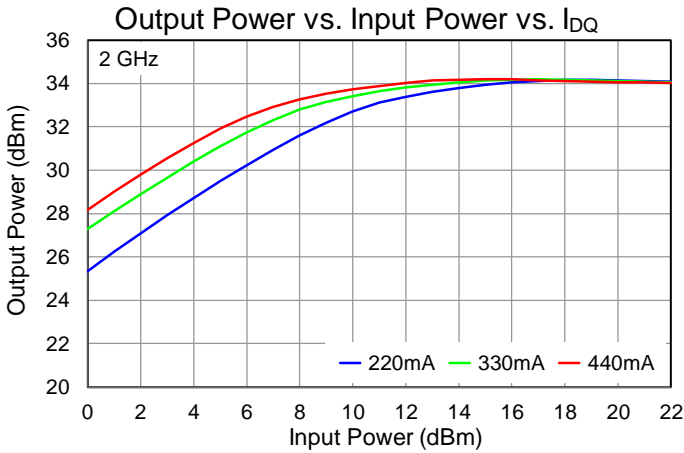

Performance Plots – Large Signal

Test conditions, unless otherwise noted: $V_D = 18\text{ V}$, $I_{DQ} = 330\text{ mA}$, $T = +25\text{ }^\circ\text{C}$

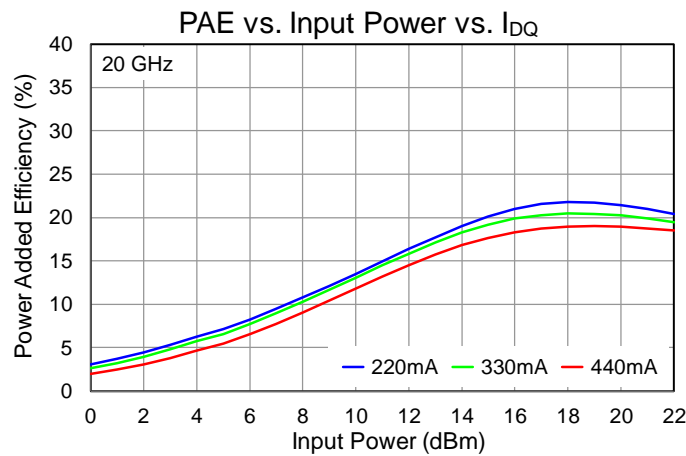
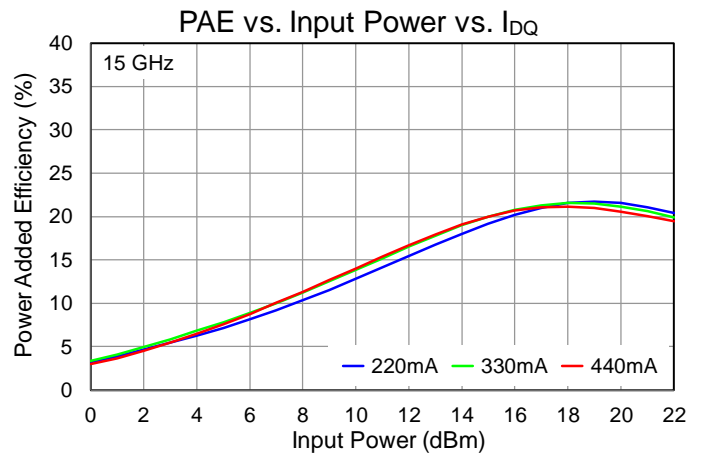
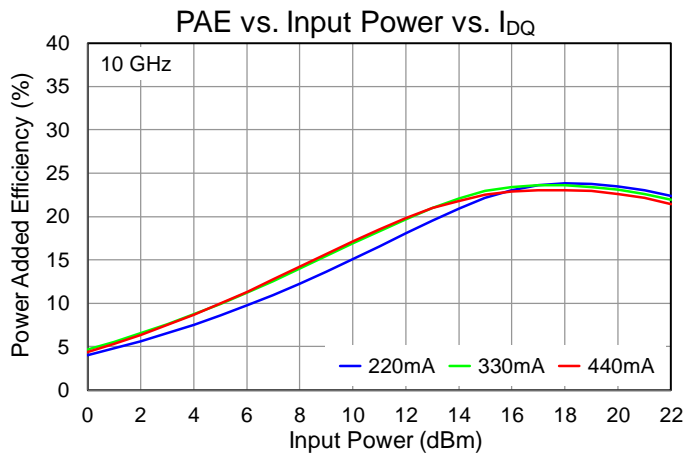
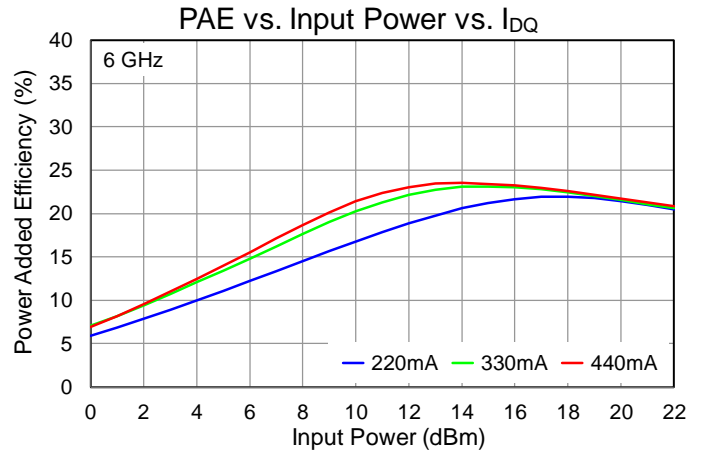
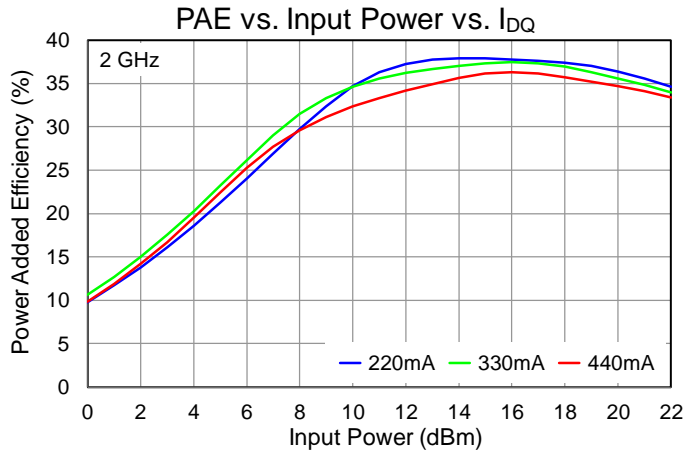

Performance Plots – Large Signal

Test conditions, unless otherwise noted: $V_D = 18\text{ V}$, $I_{DQ} = 330\text{ mA}$, $T = +25\text{ }^\circ\text{C}$

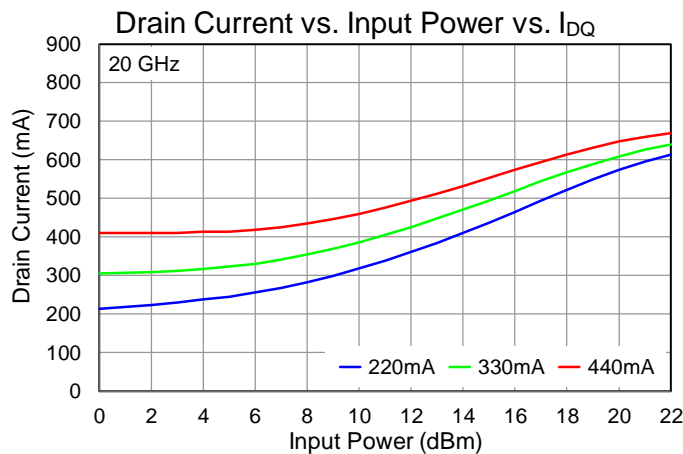
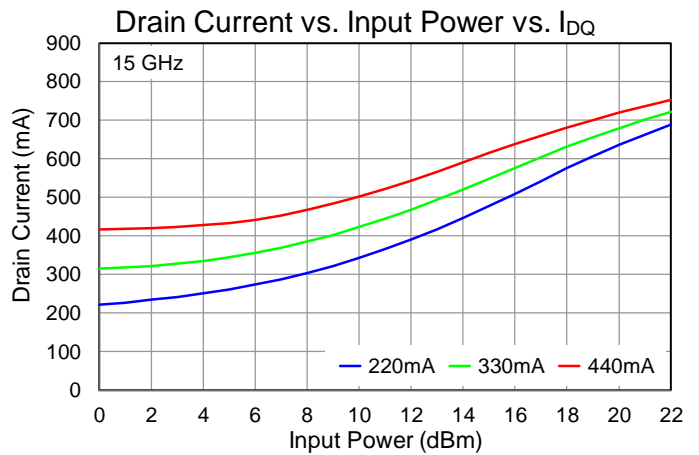
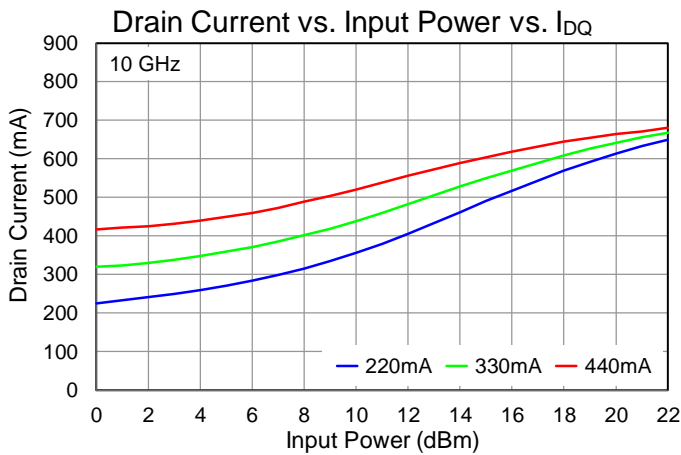
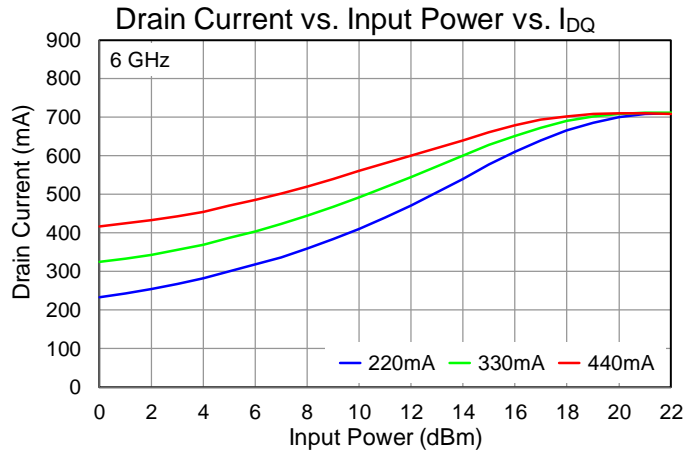
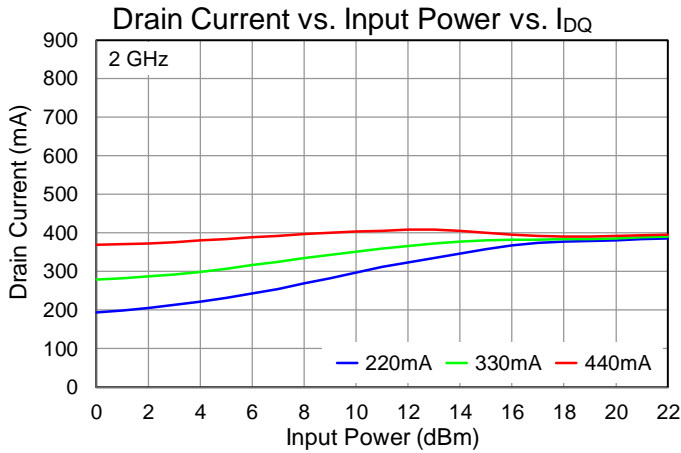

Performance Plots – Linearity

Test conditions, unless otherwise noted: $V_D = 18\text{ V}$, $I_{DQ} = 330\text{ mA}$, $T = +25\text{ }^\circ\text{C}$, 100 MHz tone spacing

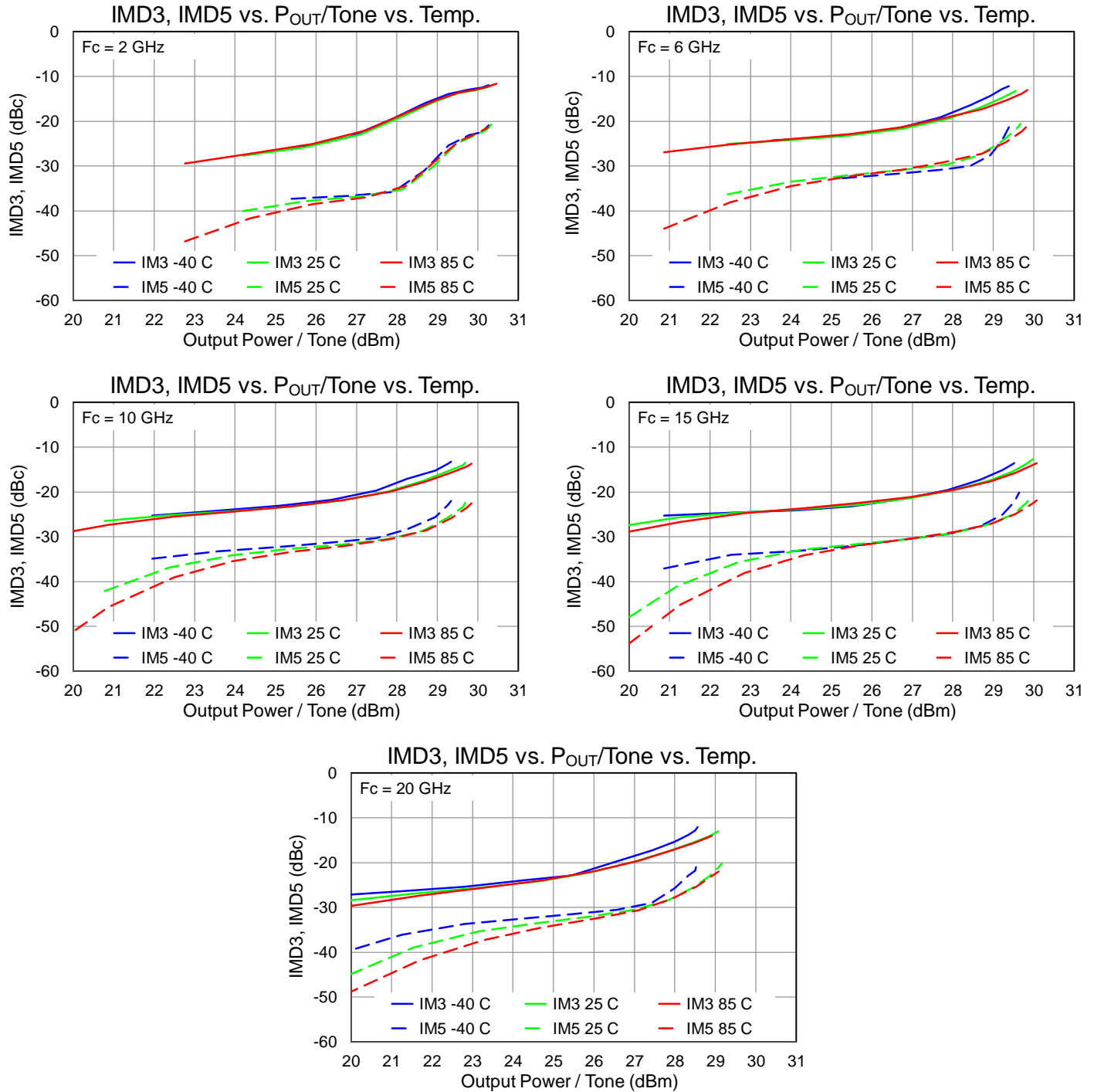

Performance Plots – Linearity

Test conditions, unless otherwise noted: $V_D = 18\text{ V}$, $I_{DQ} = 330\text{ mA}$, $T = +25\text{ }^\circ\text{C}$, 100 MHz tone spacing

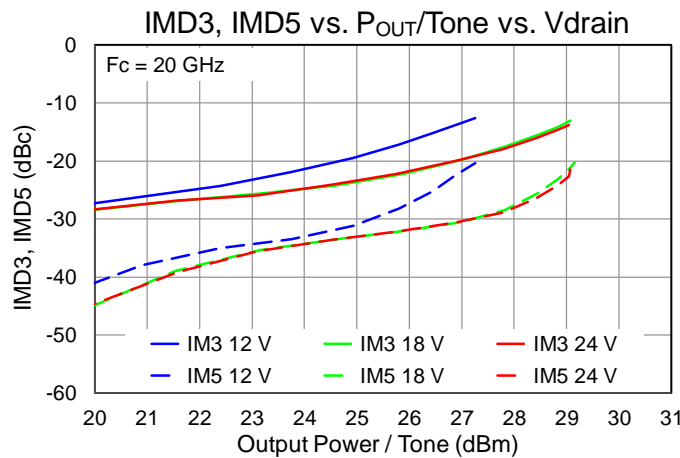
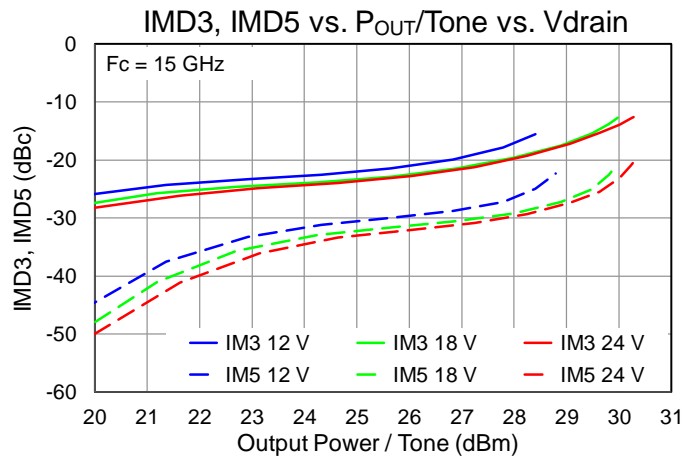
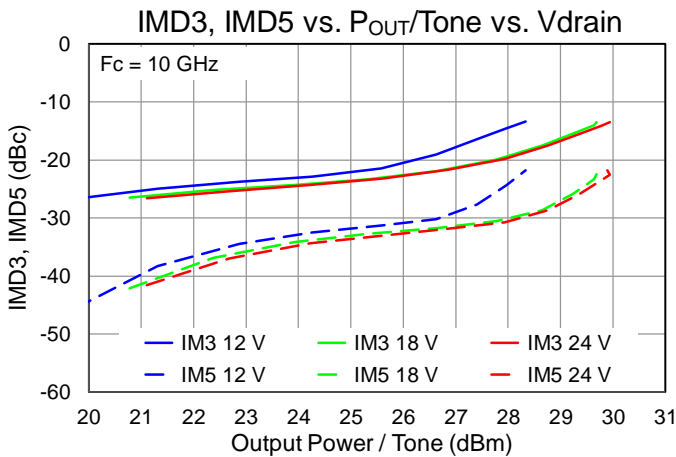
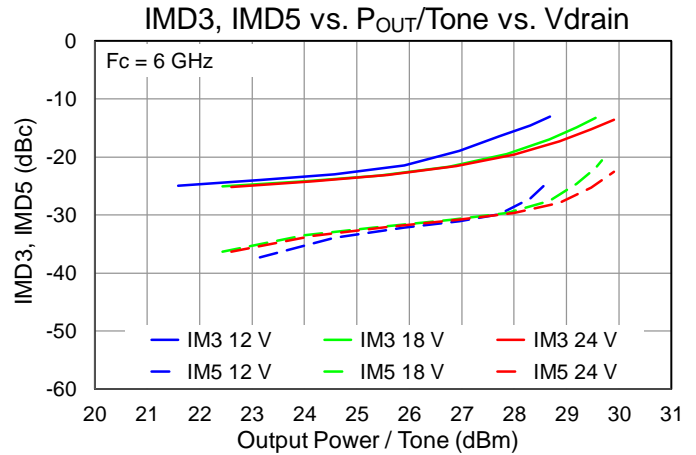
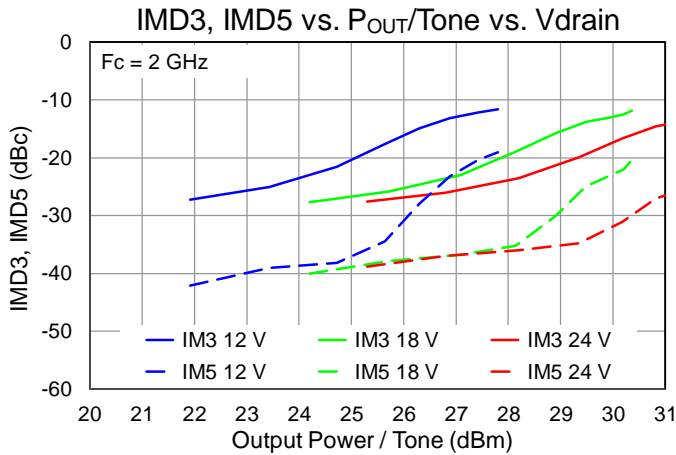

Performance Plots – Linearity

Test conditions, unless otherwise noted: $V_D = 18\text{ V}$, $I_{DQ} = 330\text{ mA}$, $T = +25\text{ }^\circ\text{C}$, 100 MHz tone spacing

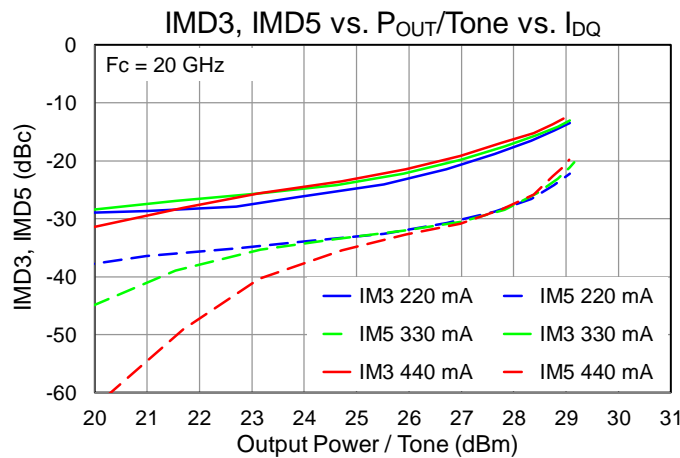
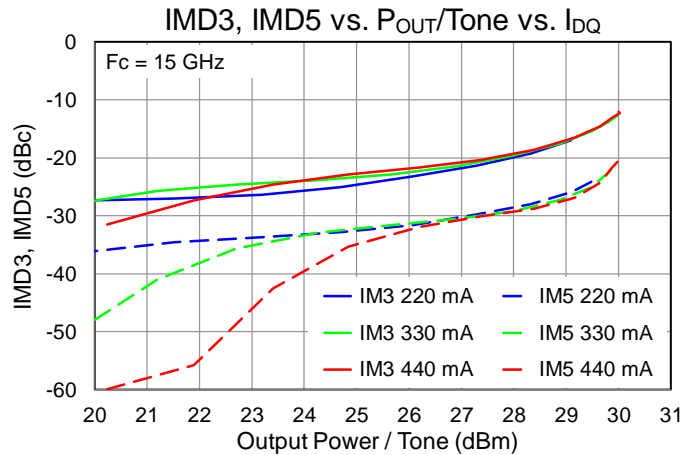
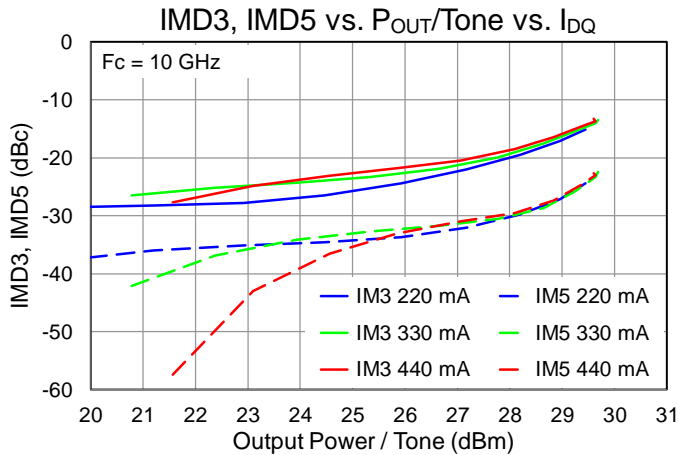
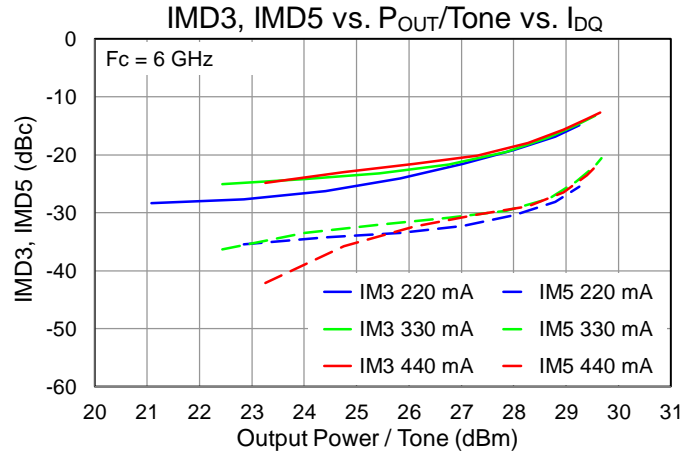
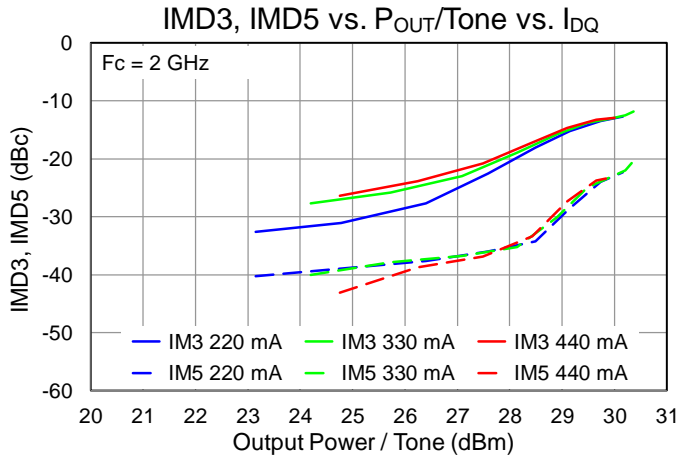

Performance Plots – Harmonics

Test conditions, unless otherwise noted: $V_D = 18\text{ V}$, $I_{DQ} = 330\text{ mA}$, $T = +25\text{ }^\circ\text{C}$, $P_{in} = 18\text{ dBm}$

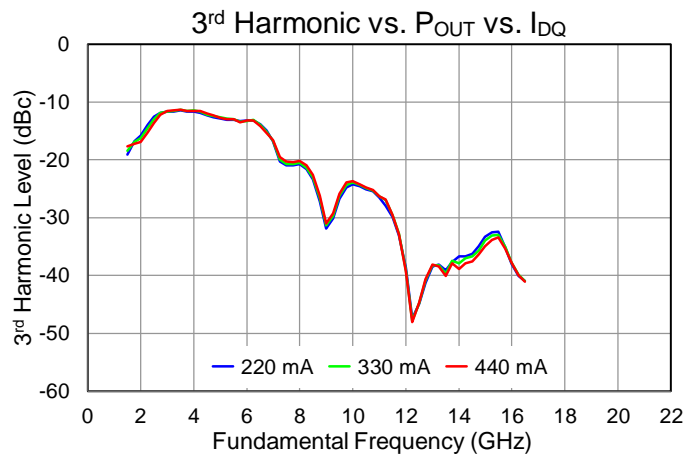
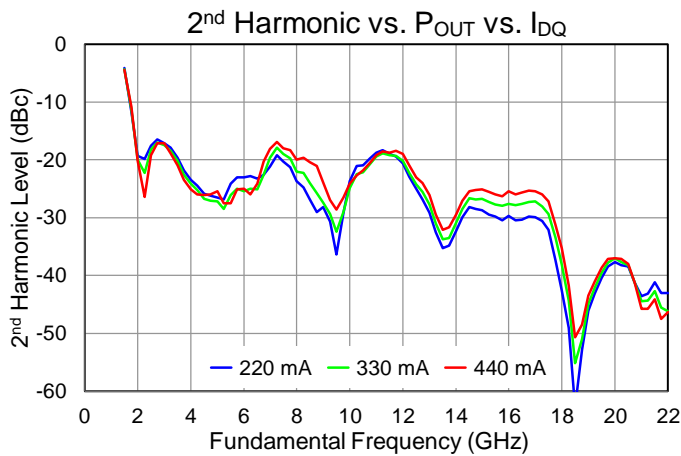
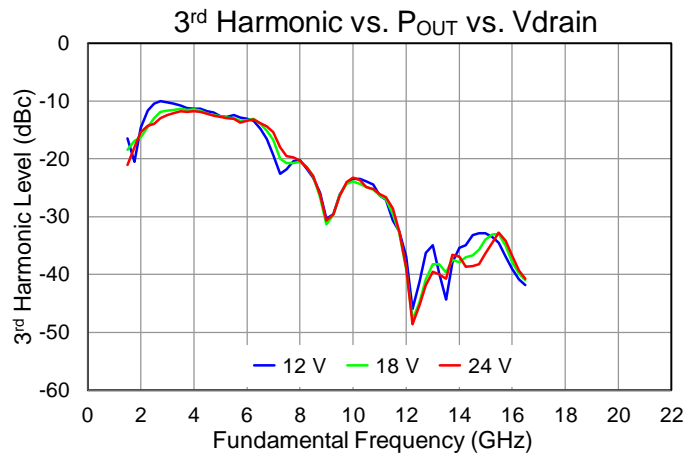
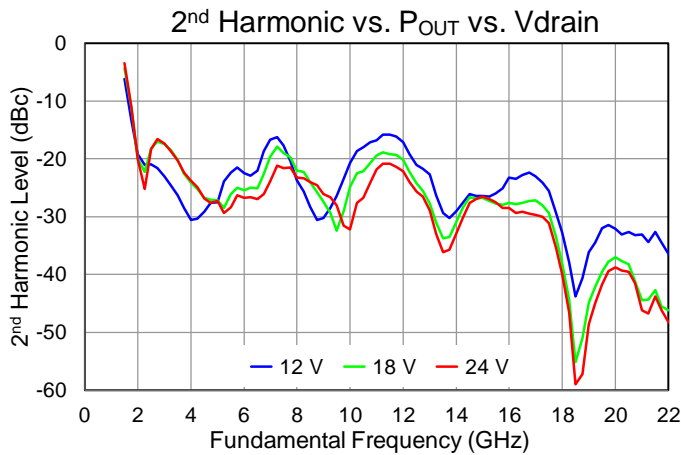
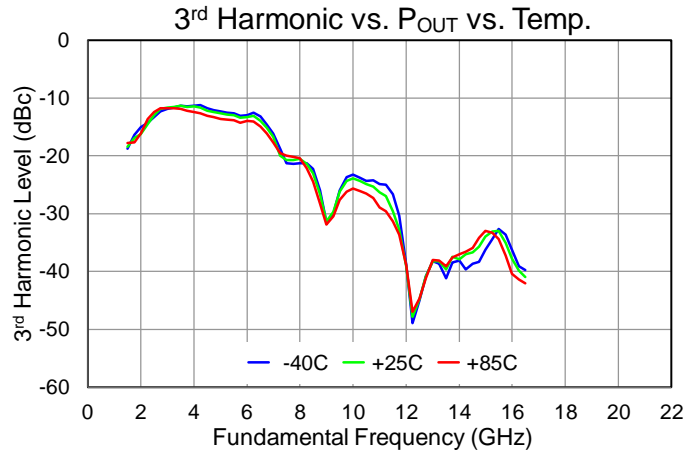
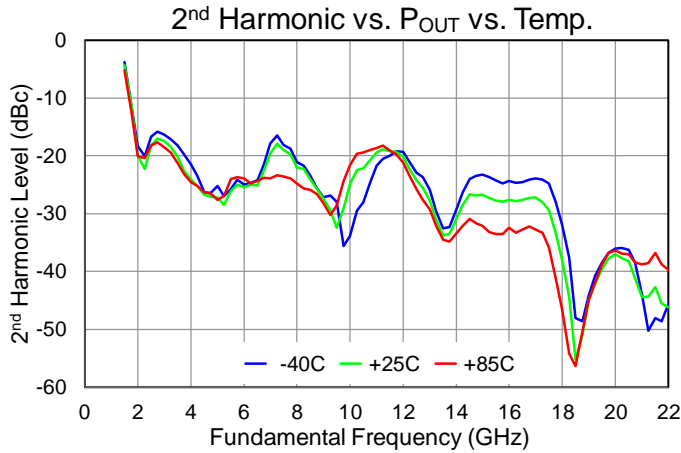

Thermal and Reliability Information

| Parameter | Test Conditions | Value | Units |
|---|---|-------|--------------------|
| Thermal Resistance (θ_{JC}) ⁽¹⁾ | $T_{base} = 85\text{ }^\circ\text{C}$, $V_D = 18\text{ V}$, $I_{DQ} = 330\text{ mA}$, $P_{DISS} = 5.94\text{ W}$, No RF (quiescent DC operation) | 4.97 | $^\circ\text{C/W}$ |
| Channel Temperature, T_{CH} (Under RF) ⁽²⁾ | | 114 | $^\circ\text{C}$ |
| Thermal Resistance (θ_{JC}) ⁽¹⁾ | $T_{base} = 85\text{ }^\circ\text{C}$, $V_D = 18\text{ V}$, $I_{DQ} = 330\text{ mA}$, Freq = 6.5 GHz, $I_{D_Drive} = 680\text{ mA}$, $P_{IN} = 18\text{ dBm}$, $P_{OUT} = 34.1\text{ dBm}$, $P_{DISS} = 9.72\text{ W}$ | 6.98 | $^\circ\text{C/W}$ |
| Channel Temperature, T_{CH} (Under RF) ⁽²⁾ | | 153 | $^\circ\text{C}$ |
| Thermal Resistance (θ_{JC}) ⁽¹⁾ | $T_{base} = 85\text{ }^\circ\text{C}$, $V_D = 22\text{ V}$, $I_{DQ} = 330\text{ mA}$, Freq = 6.5 GHz, $I_{D_Drive} = 701\text{ A}$, $P_{IN} = 18\text{ dBm}$, $P_{OUT} = 34.4\text{ dBm}$, $P_{DISS} = 12.71\text{ W}$ | 7.14 | $^\circ\text{C/W}$ |
| Channel Temperature, T_{CH} (Under RF) ⁽²⁾ | | 176 | $^\circ\text{C}$ |

Notes:

1. Thermal resistance determined to the back of package, T_{base} (85 $^\circ\text{C}$)
2. Refer to the following document: [GaN Device Channel Temperature, Thermal Resistance, and Reliability Estimates](#)

Dissipated Power and Maximum Gate Current

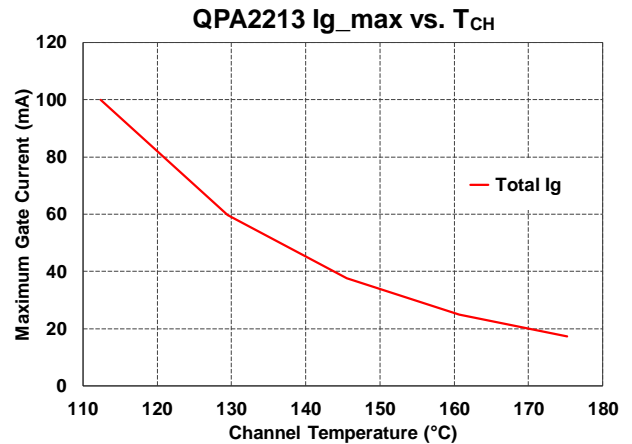
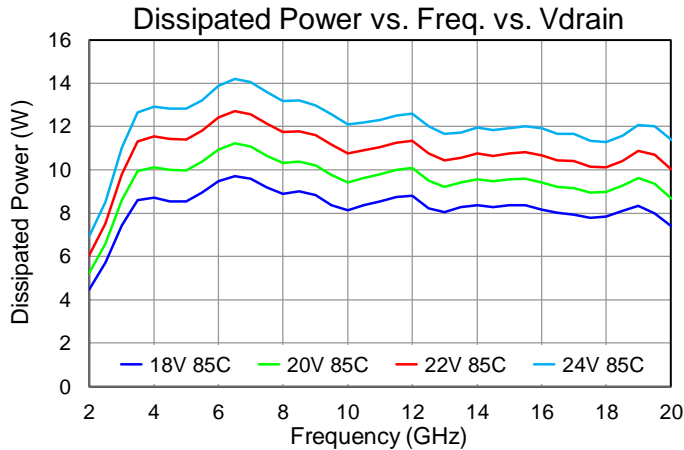

Test conditions, unless otherwise noted: $V_D = 18\text{ V}$, $I_{DQ} = 330\text{ mA}$, $T = +25\text{ }^\circ\text{C}$, $P_{in} = 18\text{ dBm}$

Applications Information

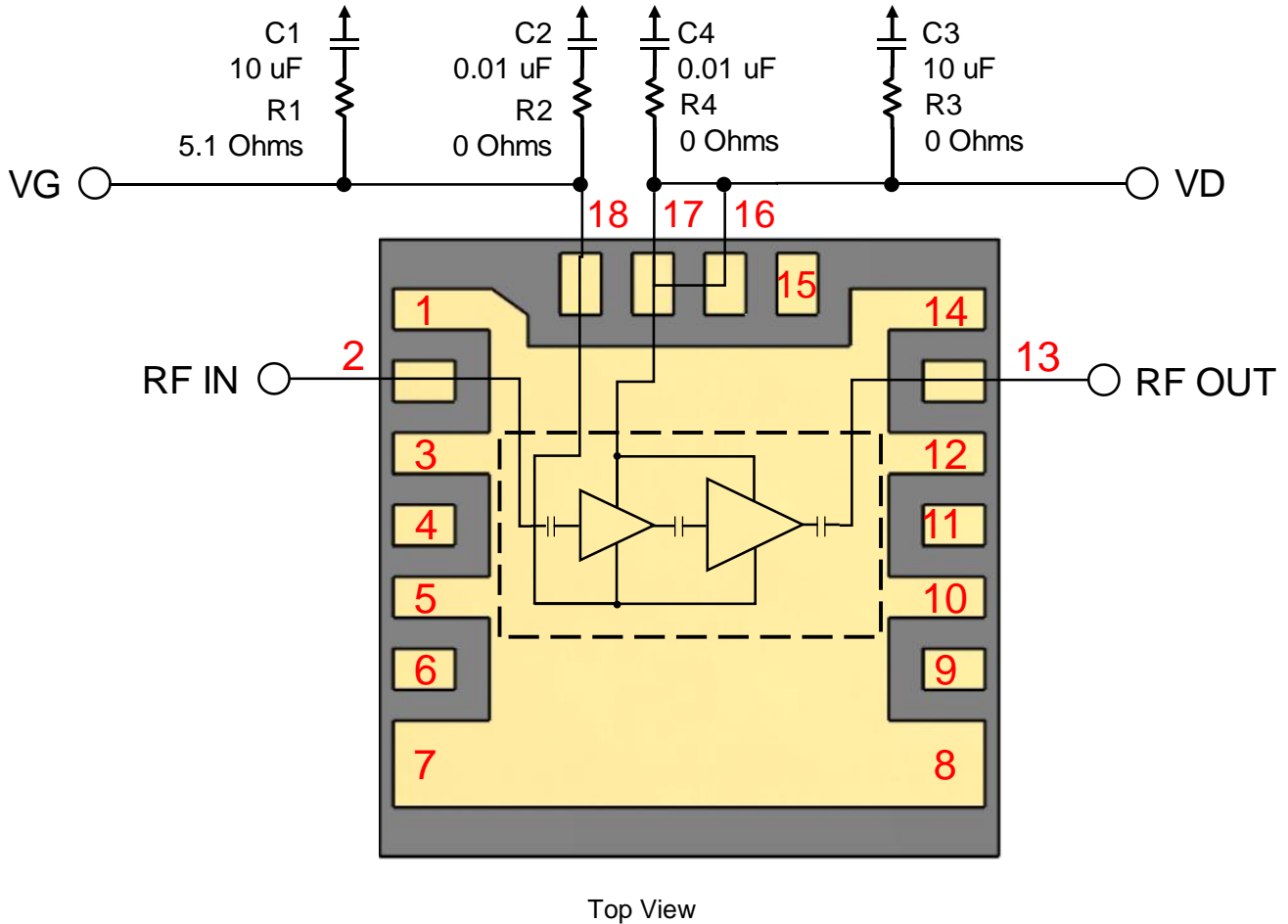

Bias-Up Procedure

1. Set I_D limit to 900 mA, I_G limit to 10 mA
2. Set V_G to -4.0 V
3. Set V_D +18 V
4. Adjust V_G more positive until $I_{DQ} \approx 330$ mA
5. Apply RF signal

Bias-Down Procedure

1. Turn off RF signal
2. Reduce V_G to -4.0 V. Ensure $I_{DQ} \sim 0$ mA
4. Set V_D to 0 V
5. Turn off V_D supply
6. Turn off V_G supply

Evaluation Board (EVB) Layout Assembly

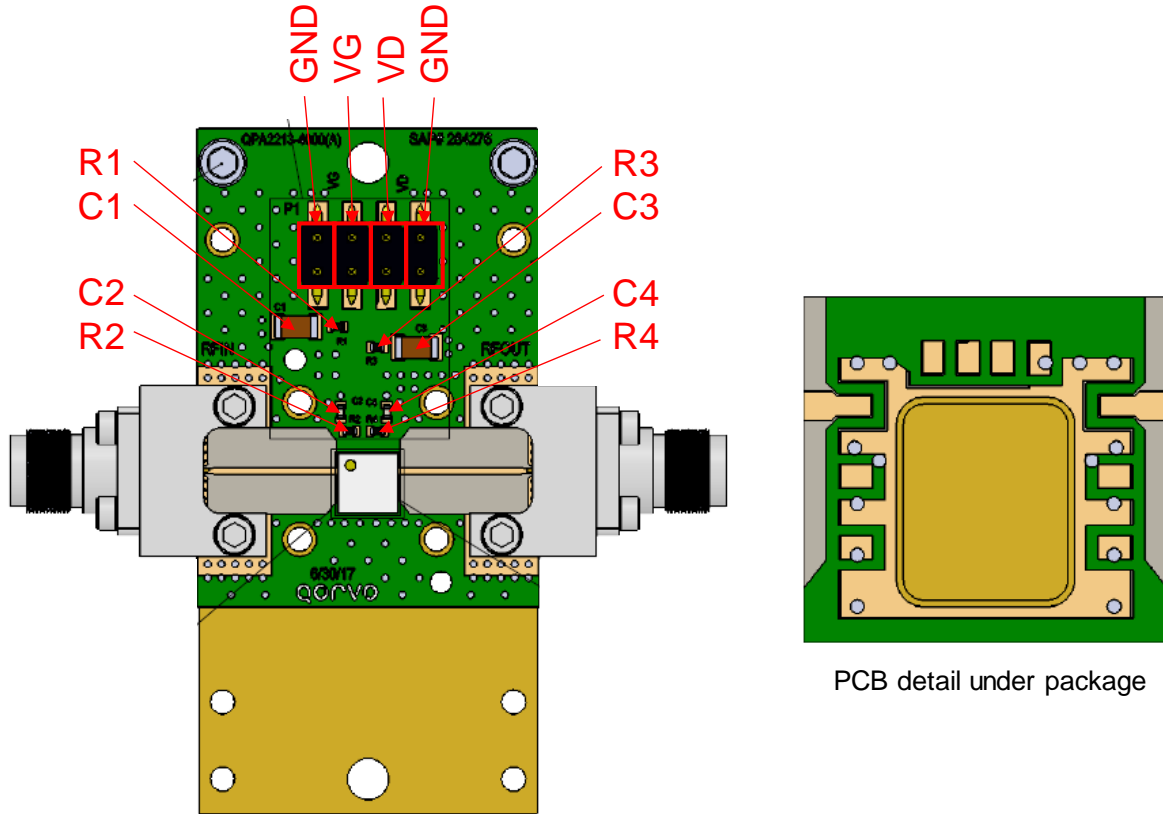

PCB is made from Rogers 4003C dielectric, .008 inch thick, 0.5 oz. copper both sides.
Carrier plate has a raised pedestal to contact the center of the package base.

Bill of Materials

| Reference Des. | Value | Description | Manuf. | Part Number |
|----------------|---------|---------------------------------------|---------------------|-------------|
| C1,C3 | 10 uF | CAP, 10 uF, 20%, 50 V, 20%, X5R, 1206 | Various | |
| C2, C4 | 0.01 uF | CAP, 0.01 uF, 10%, 50 V, X7R, 0402 | Various | |
| R1 | 5.1 Ω | RES, 5.1 OHM, 5%, 50 V, 0402 | Various | |
| R2, R3, R4 | 0 Ω | RES, 0 OHM, JMPR, 0402 | Various | |
| J1, J2 | 2.92 mm | CONNECTOR, FEMALE, ENDLAUNCH | Southwest Microwave | 1092-01A-5 |

Mechanical Information

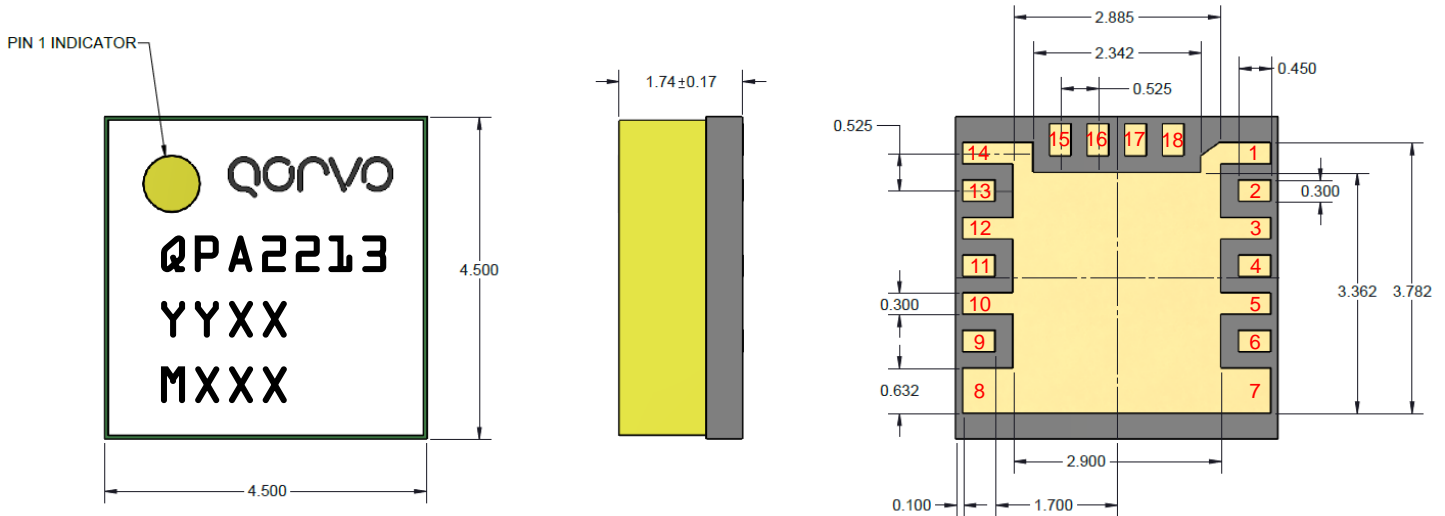

Notes:

1. Material:
 Package Base: EHS Laminate
 Package Lid: FR4
 Backside plating: Gold, 0.10 um (min.)
2. All metalized features are gold plated
3. The part is epoxy sealed

Tolerances:

- .XX = ± .25
- .XXX = ± .100
- .XXXX = ± .0245

Unless otherwise specified, dimensions are in mm

Bond Pad Description

| Pad No. | Symbol | Description |
|--------------------|--------|---|
| 1,3,5,7,8,10,12,14 | GND | Ground. Connect pads to PCB ground. |
| 2 | RF IN | RF input. 50 Ohms. DC blocked. |
| 4,6,9,11,15 | N/C | No connection. May be grounded to PCB if desired. |
| 13 | RF OUT | RF output. 50 Ohms. DC blocked. |
| 16,17 | VD | Drain voltage. External bypassing required; refer to page for recommendation. |
| 18 | VG | Gate voltage. External bypassing required; refer to page for recommendation. |

Assembly Notes

Compatible with lead-free soldering processes with 260°C peak reflow temperature.

This package is air-cavity and non-hermetic, and therefore cannot be subjected to aqueous washing. The use of no-clean solder to avoid washing after soldering is highly recommended.

Contact plating: Ni-Au

Solder rework not recommended

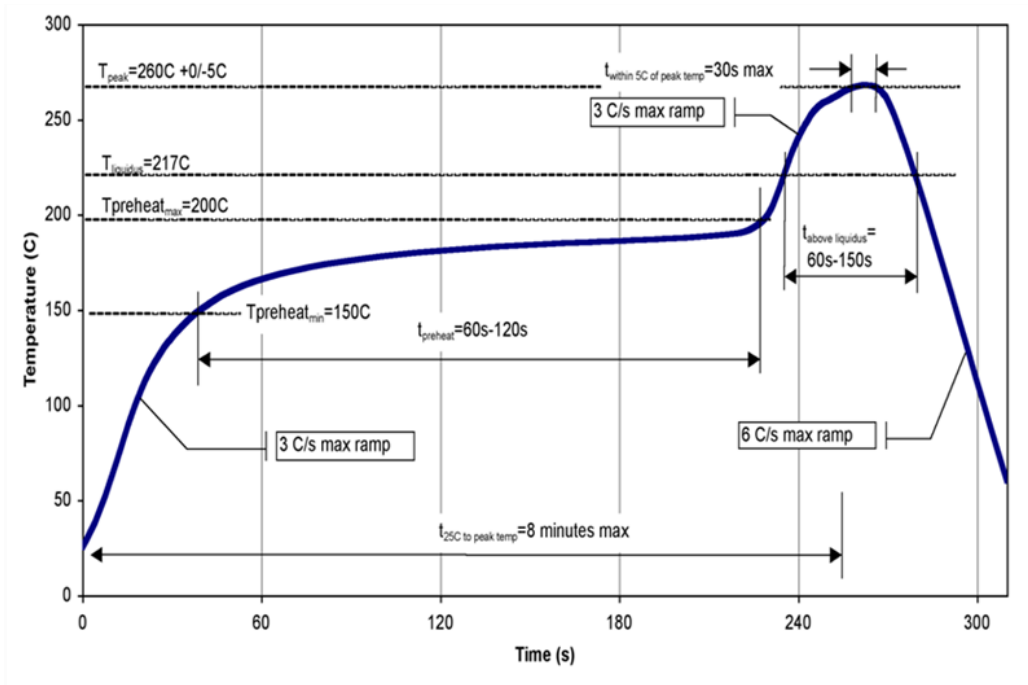

Handling Precautions

| Parameter | Rating | Standard |
|---------------------------------|--------|------------------------------------|
| ESD – Human Body Model (HBM) | 1A | ESDA / JEDEC JS-001-2012 |
| ESD – Charge Device Model (CDM) | C2A | ESDA / JEDEC JS-002-2014 |
| MSL – Convection Reflow 260 °C | 3 | JEDEC standard IPC/JEDEC J-STD-020 |



Caution!
ESD-Sensitive Device

RoHS Compliance

This product is compliant with the 2011/65/EU RoHS directive (Restrictions on the Use of Certain Hazardous Substances in Electrical and Electronic Equipment), as amended by Directive 2015/863/EU. This product also has the following attributes:

- Lead Free
- Antimony Free
- TBBP-A (C₁₅H₁₂Br₄O₂) Free

Contact Information

For the latest specifications, additional product information, worldwide sales and distribution locations:

Tel: 1-844-890-8163

Web: www.qorvo.com

Email: customer.support@qorvo.com

Important Notice

The information contained herein is believed to be reliable; however, Qorvo makes no warranties regarding the information contained herein and assumes no responsibility or liability whatsoever for the use of the information contained herein. All information contained herein is subject to change without notice. Customers should obtain and verify the latest relevant information before placing orders for Qorvo products. The information contained herein or any use of such information does not grant, explicitly or implicitly, to any party any patent rights, licenses, or any other intellectual property rights, whether with regard to such information itself or anything described by such information. **THIS INFORMATION DOES NOT CONSTITUTE A WARRANTY WITH RESPECT TO THE PRODUCTS DESCRIBED HEREIN, AND QORVO HEREBY DISCLAIMS ANY AND ALL WARRANTIES WITH RESPECT TO SUCH PRODUCTS WHETHER EXPRESS OR IMPLIED BY LAW, COURSE OF DEALING, COURSE OF PERFORMANCE, USAGE OF TRADE OR OTHERWISE, INCLUDING THE IMPLIED WARRANTIES OF MERCHANTABILITY AND FITNESS FOR A PARTICULAR PURPOSE.**

Without limiting the generality of the foregoing, Qorvo products are not warranted or authorized for use as critical components in medical, life-saving, or life-sustaining applications, or other applications where a failure would reasonably be expected to cause severe personal injury or death.

Copyright 2020 © Qorvo, Inc. | Qorvo is a registered trademark of Qorvo, Inc.

X-ON Electronics

Largest Supplier of Electrical and Electronic Components

Click to view similar products for [RF Development Tools](#) category:

Click to view products by [Qorvo](#) manufacturer:

Other Similar products are found below :

[MAAM-011117](#) [MAAP-015036-DIEEV2](#) [EV1HMC1113LP5](#) [EV1HMC6146BLC5A](#) [EV1HMC637ALP5](#) [EVAL-ADG919EBZ](#) [ADL5363-EVALZ](#) [LMV228SDEVAL](#) [SKYA21001-EVB](#) [SMP1331-085-EVB](#) [EV1HMC618ALP3](#) [EVAL01-HMC1041LC4](#) [MAAL-011111-000SMB](#) [MAAM-009633-001SMB](#) [MASW-000936-001SMB](#) [107712-HMC369LP3](#) [107780-HMC322ALP4](#) [SP000416870](#) [EV1HMC470ALP3](#) [EV1HMC520ALC4](#) [EV1HMC244AG16](#) [MAX2614EVKIT#](#) [124694-HMC742ALP5](#) [SC20ASATEA-8GB-STD](#) [MAX2837EVKIT+](#) [MAX2612EVKIT#](#) [MAX2692EVKIT#](#) [EV1HMC629ALP4E](#) [SKY12343-364LF-EVB](#) [108703-HMC452QS16G](#) [EV1HMC863ALC4](#) [EV1HMC427ALP3E](#) [119197-HMC658LP2](#) [EV1HMC647ALP6](#) [ADL5725-EVALZ](#) [MAX2371EVKIT#](#) [106815-HMC441LM1](#) [EV1HMC1018ALP4](#) [UXN14M9PE](#) [MAX2016EVKIT](#) [EV1HMC939ALP4](#) [MAX2410EVKIT](#) [MAX2204EVKIT+](#) [EV1HMC8073LP3D](#) [SIMSA868-DKL](#) [SIMSA868C-DKL](#) [SKY65806-636EK1](#) [SKY68020-11EK1](#) [SKY67159-396EK1](#) [SKY66181-11-EK1](#)