

General Description

The QPA4363C is a high performance SiGe MMIC amplifier utilizing a Darlington configuration with a patented active bias network. The active bias network provides stable current over temperature and process Beta variations. Designed to run directly from a 3V supply, the QPA4363C does not require a dropping resistor as compared to typical Darlington amplifiers. The QPA4363C is designed for high linearity 3V gain block applications that require small size and minimal external components. It is internally matched to 50Ω.



6 Lead SOT-363 Package

Product Features

- 50 to 4000 MHz Operation
- Single fixed 3V Supply
- Patented Self-Bias Circuitry
- 13.6 dB Gain at 1950 MHz
- +26.5 dBm OIP3 at 1950 MHz
- Cascadable 50 Ω
- Low Thermal Resistance Package

Functional Block Diagram

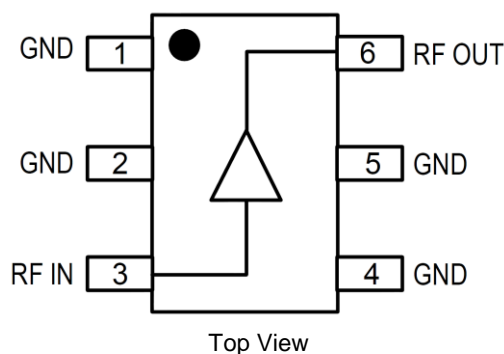

Applications

- Instrumentation
- Repeaters
- Boosters
- PA Driver Amplifier
- Cellular, PCS, GSM, UMTS
- IF Amplifier
- Wireless Data, Satellite

Ordering Information

Part No.	Description
QPA4363CTR7	3000 pieces on a 7" reel (standard)
QPA4363CSQ	25 Piece Sample Bag
QPA4363CSR	100 Pieces on 7" Reel
QPA4363CPCK401	850 MHz, EVB with 5 Piece Sample Bag

Absolute Maximum Ratings

Parameter	Rating
Storage Temp	-55 to +150 °C
Device Voltage (V _D)	+4 V
Device Current (I _D)	110 mA
RF Input Power	+12 dBm

Exceeding any one or a combination of the Absolute Maximum Rating conditions may cause permanent damage to the device. Extended application of Absolute Maximum Rating conditions to the device may reduce device reliability.

Recommended Operating Conditions

Parameter	Min	Typ	Max	Units
Operating Temperature	-40		+105	°C
Junction Temperature (T _J)			+125	°C
Device Operating Voltage		+3.0		V

Electrical specifications are measured at specified test conditions. Specifications are not guaranteed over all recommended operating conditions.

Electrical Specifications

Parameter	Conditions ⁽¹⁾	Min	Typ	Max	Units
Small Signal Gain	850 MHz		16.6		dB
	1950 MHz		13.6		dB
	2400 MHz		12		dB
Output Power at 1dB Compression	850 MHz		+14.8		dBm
	1950 MHz		+13.7		dBm
	2400 MHz		+13.4		dBm
Output Third Intercept Point	500 MHz		+30.5		dBm
	850 MHz		+30		dBm
	1950 MHz ⁽²⁾		+26.4		dBm
Input Return Loss	2400 MHz		+26		dBm
	850 MHz		-15.5		dB
	1950 MHz		-14.3		dB
Output Return Loss	2400 MHz		-13		dB
	850 MHz		-22		dB
	1950 MHz		-15.5		dB
Reverse Isolation	2400 MHz		-14.5		dB
	850 MHz		-21		dB
	1950 MHz		-20		dB
Noise Figure	2400 MHz		-19.5		dB
	850 MHz		4.2		dB
	1950 MHz		4.3		dB
Device Operating Current			55		mA
Thermal Resistance, θ_{jc}			107		°C/W

Notes:

1. Test conditions unless otherwise noted: V_D = +3.0 V, I_D = 55 mA Typ., OIP3 Tone Spacing=1 MHz, P_{OUT} per tone = -6 dBm, 50 Ω system, Temp = +25 °C
2. P_{out}/tone = -5dBm

Evaluation Board and Schematic – 850 MHz Application Circuit

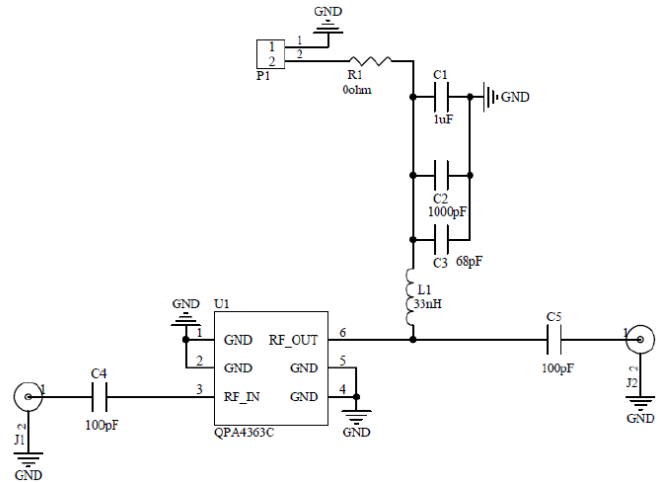

Bill of Material – 850 MHz Application Circuit

Reference	Value	Description	Manufacturer	Part Number
n/a	n/a	PCB, QPA4363C	Qorvo	QPAXX63X-410(A)
C1	1 uF	CAP, 10%, 25V, X7R, 1206	Murata Electronics	GRM31MR71E105KA01L
C2	1000 pF	CAP, 10%, 50V, X7R, 0402	Murata Electronics	GRM155R71H102KA01D
C3	68 pF	CAP, 5%, 50V, C0G, 0402	Murata Electronics	GRM1555C1H680JA01D
C4, C5	100 pF	CAP, 5%, 50V, C0G, 0402	Murata Electronics	GRM1555C1H101JA01D
R1	0 Ω	RES, 0 Ω, 1210	KOA Speer Electronics	RK73Z2ETTD
L1	33 nH	IND, 5%, M/L, 0603	Murata Electronics	LL1608-FSL33NJ
J1, J2	n/a	CONN, SMA, EL, FLT, 0.068" SPE-000318	Amphenol RF Asia Corp	901-10426
U1	n/a	SiGe MMIC Amplifier	Qorvo	QPA4363C
J3, J4	n/a	CONN, HDR, ST, 1x2, 0.100", Hi-temp, T/H	Samtec Inc	HTSW-102-07-G-S

Component Values for Specific Frequencies

Frequency	500 MHz	850 MHz	1950 MHz	2400 MHz	3500 MHz
C4, C5	220 pF	100 pF	68 pF	56 pF	39 pF
C3	100 pF	68 pF	22 pF	22 pF	15 pF
L1	68 nH	33 nH	22 nH	18 nH	15 nH

Typical Performance – 850 MHz Application Circuit

Parameter	Typical Value					Units
Frequency	500	850	1950	2400	3500	MHz
Small Signal Gain	17	16.6	13.6	12	8.6	dB
Output Third Intercept Point	+30.5	+29.8	+26.5	+25.9	+23.2	dBm
Output Power at 1dB Compression	+15	+14.8	+13.7	+13.4	+11.7	dBm
Input Return Loss	-15	-15.8	-14.3	-13	-11	dB
Output Return Loss	-13.4	-22	-15.8	-14.5	-15.6	dB
Reverse Isolation	-21	-21	-20	-19.6	-18.7	dB
Noise Figure	4.0	4.2	4.3	4.5	5.6	dB

Notes:

- Test conditions unless otherwise noted: $V_D = +3.0\text{ V}$, $I_D = 55\text{ mA Typ.}$, OIP3 Tone Spacing=1 MHz, P_{OUT} per tone = -6 dBm, 50 Ω system, Temp = +25 °C

Performance Plots – 850 MHz Application Circuit

Test conditions unless otherwise noted: $V_D = +3.0\text{ V}$, $I_D = 55\text{ mA}$, OIP3 Tone Spacing=1 MHz, P_{OUT} per tone = -6 dBm, Temp.= +25 °C

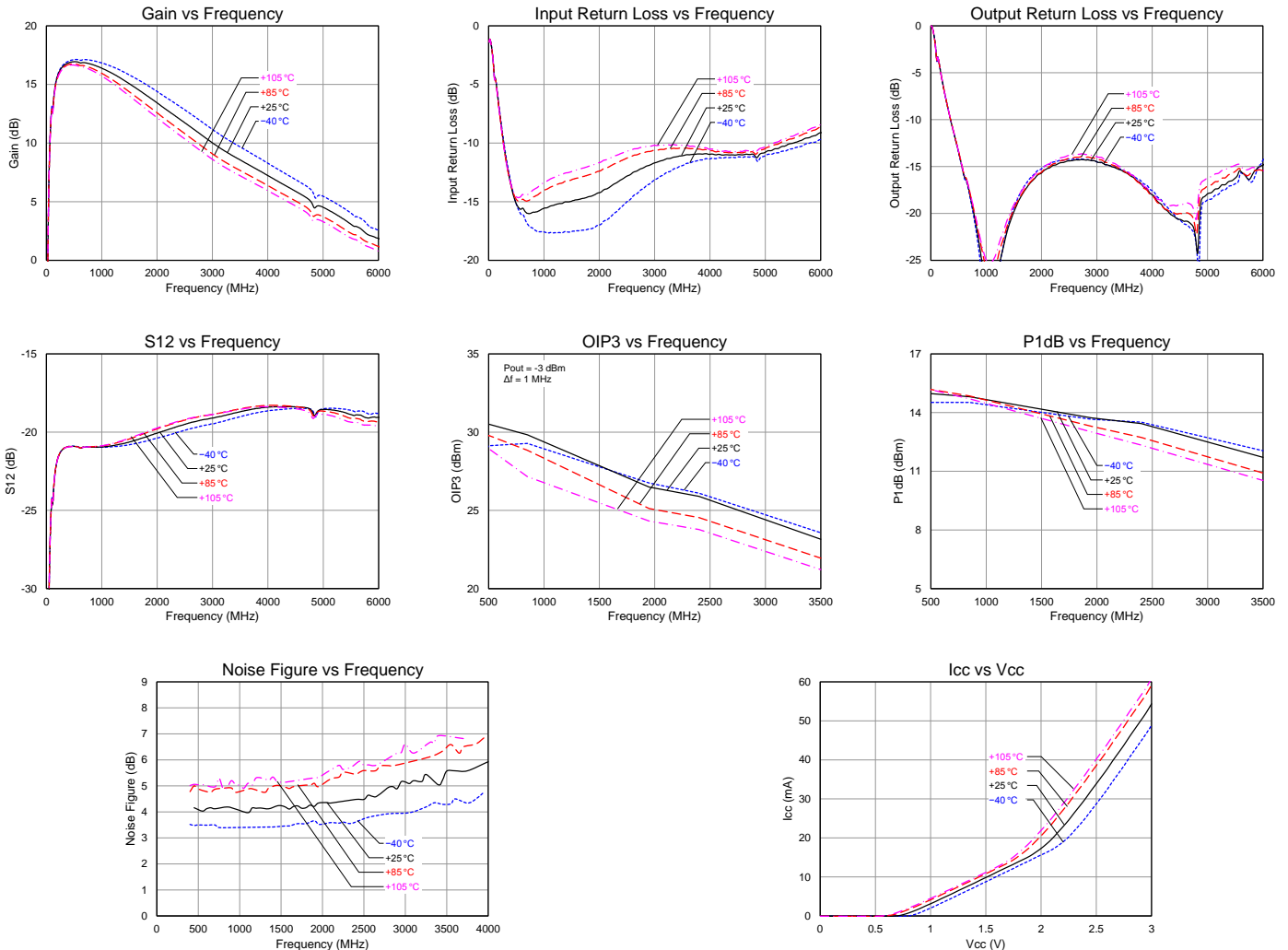

Pin Configuration and Description

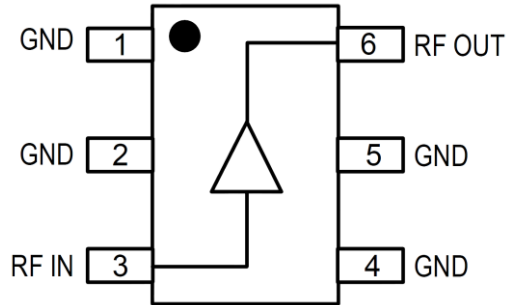

Top View

Pad No.	Label	Description
1, 2, 4, 5	GND	Connection to ground. Use via holes in PCB for best performance to reduce lead inductance as close to ground leads as possible
3	RF _{IN}	RF Input Pin. This pin requires the use of an external DC blocking capacitor chosen for the frequency of operation.
6	RF _{OUT}	RF Output and Bias Pin. DC voltage is present on this pin, therefore a DC blocking capacitor is necessary for proper operation.

Package Marking

XXXX: Alpha-numeric Trace Code

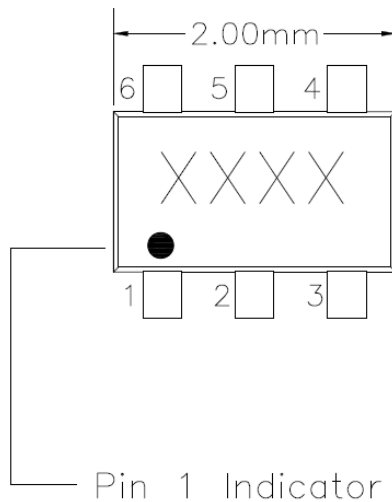

Package Dimensions

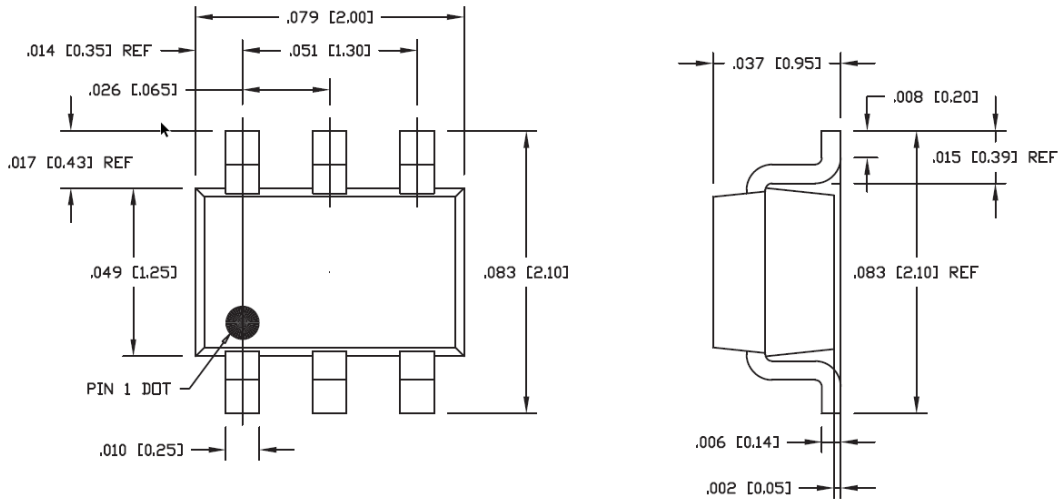

- Notes:
1. All dimensions are in inches (millimeters). Angles are in degrees.
 2. Dimension and tolerance formats conform to ASME Y15.5-2009.

PCB Mounting Pattern

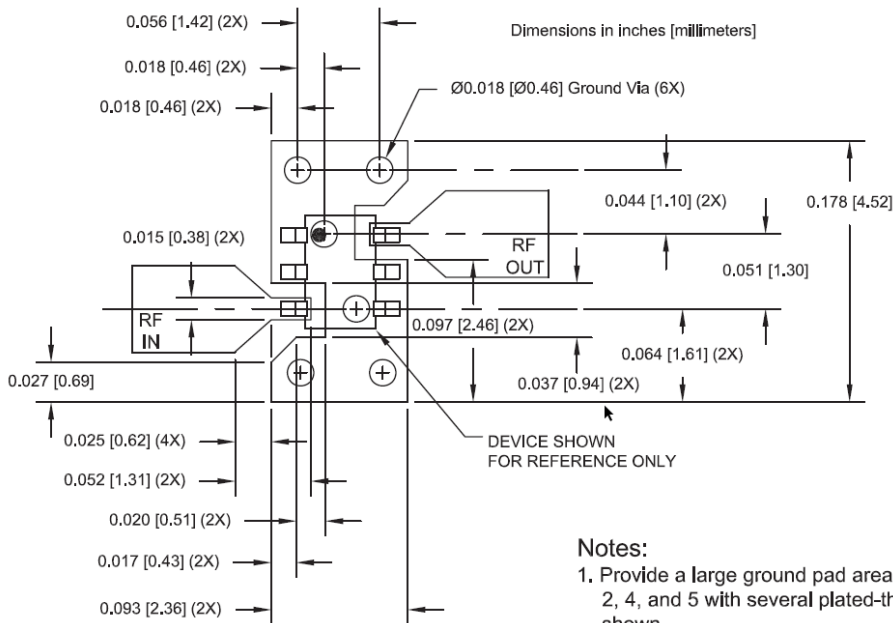

- Notes:
1. Provide a large ground pad area under device pins 1, 2, 4, and 5 with several plated-through holes placed as shown.
 2. 1/2 ounce finished copper thickness is recommended.
 3. RF I/O lines are 50Ω

- Notes:
1. All dimensions are in inches (millimeters). Angles are in degrees.

Handling Precautions

Parameter	Rating	Standard
ESD – Human Body Model (HBM)	2	ESDA / JEDEC JS-001-2014
ESD – Charged Device Model (CDM)	C3	ESDA / JEDEC JS-002-2014
MSL – Moisture Sensitivity Level	Level 1	IPC/JEDEC J-STD-020



Caution!
 ESD-Sensitive Device

Solderability

Compatible with lead-free (260°C max. reflow temp.) soldering process.
 Solder profiles available upon request.
 Contact plating: Matte Sn

RoHS Compliance

This part is compliant with 2011/65/EU RoHS directive (Restrictions on the Use of Certain Hazardous Substances in Electrical and Electronic Equipment) as amended by Directive 2015/863/EU.

This product also has the following attributes:

- Lead Free
- Halogen Free (Chlorine, Bromine)
- Antimony Free
- TBBP-A (C₁₅H₁₂Br₄O₂) Free
- PFOS Free
- SVHC Free



Contact Information

For the latest specifications, additional product information, worldwide sales and distribution locations:

Web: www.qorvo.com

Tel: 1-844-890-8163

Email: customer.support@qorvo.com

For technical questions and application information: **Email:** sicapplications.engineering@qorvo.com

Important Notice

The information contained herein is believed to be reliable; however, Qorvo makes no warranties regarding the information contained herein and assumes no responsibility or liability whatsoever for the use of the information contained herein. All information contained herein is subject to change without notice. Customers should obtain and verify the latest relevant information before placing orders for Qorvo products. The information contained herein or any use of such information does not grant, explicitly or implicitly, to any party any patent rights, licenses, or any other intellectual property rights, whether with regard to such information itself or anything described by such information. **THIS INFORMATION DOES NOT CONSTITUTE A WARRANTY WITH RESPECT TO THE PRODUCTS DESCRIBED HEREIN, AND QORVO HEREBY DISCLAIMS ANY AND ALL WARRANTIES WITH RESPECT TO SUCH PRODUCTS WHETHER EXPRESS OR IMPLIED BY LAW, COURSE OF DEALING, COURSE OF PERFORMANCE, USAGE OF TRADE OR OTHERWISE, INCLUDING THE IMPLIED WARRANTIES OF MERCHANTABILITY AND FITNESS FOR A PARTICULAR PURPOSE.**

Without limiting the generality of the foregoing, Qorvo products are not warranted or authorized for use as critical components in medical, life-saving, or life-sustaining applications, or other applications where a failure would reasonably be expected to cause severe personal injury or death.

Copyright 2016 © Qorvo, Inc. | Qorvo is a registered trademark of Qorvo, Inc.

X-ON Electronics

Largest Supplier of Electrical and Electronic Components

Click to view similar products for [RF Amplifier](#) category:

Click to view products by [Qorvo](#) manufacturer:

Other Similar products are found below :

[A82-1](#) [BGA622H6820XTSA1](#) [BGA 728L7 E6327](#) [BGB719N7ESDE6327XTMA1](#) [HMC397-SX](#) [HMC405](#) [HMC561-SX](#) [HMC8120-SX](#)
[HMC8121-SX](#) [HMC-ALH382-SX](#) [HMC-ALH476-SX](#) [SE2433T-R](#) [SMA3101-TL-E](#) [SMA39](#) [A66-1](#) [A66-3](#) [A67-1](#) [LX5535LQ](#) [LX5540LL](#)
[MAAM02350](#) [HMC3653LP3BETR](#) [HMC549MS8GETR](#) [HMC-ALH435-SX](#) [SMA101](#) [SMA32](#) [SMA411](#) [SMA531](#) [SST12LP17E-XX8E](#)
[SST12LP19E-QX6E](#) [WPM0510A](#) [HMC5929LS6TR](#) [HMC5879LS7TR](#) [HMC1126](#) [HMC1087F10](#) [HMC1086](#) [HMC1016](#) [SMA1212](#)
[MAX2689EWS+T](#) [MAAMSS0041TR](#) [MAAM37000-A1G](#) [LTC6430AIUF-15#PBF](#) [CHA5115-QDG](#) [SMA70-2](#) [SMA4011](#) [A231](#) [HMC-](#)
[AUH232](#) [LX5511LQ](#) [LX5511LQ-TR](#) [HMC7441-SX](#) [HMC-ALH310](#)