

### Product Overview

The QPA7489A is a high performance SiGe HBT MMIC amplifier. A Darlington configuration provides high FT and excellent thermal performance. The heterojunction increases breakdown voltage and minimizes leakage current between junctions. Cancellation of emitter junction non-linearities results in higher suppression of intermodulation products.

The QPA7489A may be operated from a variety of supply voltages by using a voltage dropping resistor. Two DC-blocking capacitors, bypass capacitors and an optional RF choke complete the circuit required for operation of this internally matched 50 ohm device.

The QPA7489A is assembled in an industry standard SOT-89 package that is lead-free and RoHS-compliant.



3 Lead SOT-89 Package

### Key Features

- DC to 3500 MHz Operation
- Single Positive Voltage Supply
- Cascadable 50  $\Omega$
- Gain: 17.7 dB at 1950 MHz
- Output IP3: +37.7 dBm typical at 850 MHz
- Noise Figure: 3.2 dB Typical at 1950 MHz
- Low Thermal Resistance SOT-89 Package
- Lead-free / RoHS-Compliant

### Functional Block Diagram

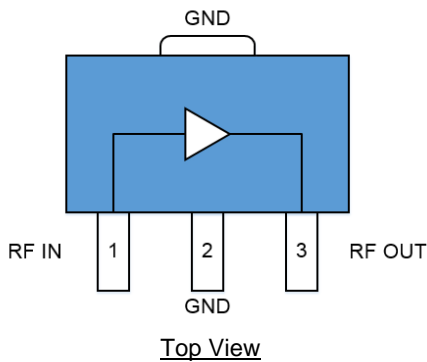

### Applications

- Cellular, PCS, GSM, UMTS
- Power Amplifier Driver
- IF/RF Buffer Amplifier
- Wireless Data, Satellite

### Ordering Information

Part No.	Description
QPA7489ASQ	25 Piece Sample Bag
QPA7489ASR	100 Pieces on 7" Reel
QPA7489ATR13	3000 pieces on a 13" reel
QPA7489APCK401	850 MHz, EVB with 5 Piece Sample Bag

## Absolute Maximum Ratings

Parameter	Rating
Storage Temp	-55 to +150 °C
Device Voltage (V <sub>D</sub> )	+7 V
Device Current (I <sub>D</sub> )	170 mA
RF Input Power (Z <sub>L</sub> = 50 Ω)	+16 dBm
RF Input Power (Z <sub>L</sub> = 10:1 VSWR)*	+2 dBm

Exceeding any one or a combination of the Absolute Maximum Rating conditions may cause permanent damage to the device. Extended application of Absolute Maximum Rating conditions to the device may reduce device reliability.

Bias Conditions should also satisfy the following expression:

$$I_D \times V_D < (T_{JUNCTION} - T_{LEAD}) / R_{TH}$$

\* Take into account out of band load VSWR presented by devices such a SAW filters to determine maximum RF input power. Reflected harmonic levels in saturation are significant.

## Recommended Operating Conditions

Parameter	Min	Typ	Max	Units
Operating Temperature	-40		+85	°C
Junction Temperature (T <sub>J</sub> )			+125	°C

Electrical specifications are measured at specified test conditions. Specifications are not guaranteed over all recommended operating conditions.

## Electrical Specifications

Parameter	Conditions	Min	Typ	Max	Units
Small Signal Gain, S <sub>21</sub>	850 MHz		21.2		dB
	1950 MHz		17.7		
	2400 MHz		16.9		
Output Power at 1dB Compression	850 MHz		+22.1		dBm
	1950 MHz		+21.1		
	2400 MHz		+20.1		
Output Third Intercept Point	500 MHz		+39.1		dBm
	850 MHz		+37.7		
	1950 MHz		+34.1		
	2400 MHz		+32.5		
Input Return Loss, S <sub>11</sub>	850 MHz		10.5		dB
	1950 MHz		12.3		
	2400 MHz		14.9		
Output Return Loss, S <sub>22</sub>	850 MHz		11.8		dB
	1950 MHz		6.2		
	2400 MHz		6.3		
Reverse Isolation, S <sub>12</sub>	850 MHz		23.8		dB
	1950 MHz		23.5		
	2400 MHz		23.3		
Noise Figure	850 MHz		2.8		dB
	1950 MHz		3.2		
	2400 MHz		3.4		
Device Operating Voltage		+4.7	+5.0	+5.3	V
Device Operating Current			118		mA
Thermal Resistance			45		°C/W

Notes:

- Test conditions unless otherwise noted: V<sub>S</sub> = +8 V, R<sub>BIAS</sub> = 26 Ω, I<sub>D</sub> = 118 mA Typ., OIP3 Tone Spacing = 1 MHz, P<sub>OUT</sub> per tone = 0 dBm, T<sub>LEAD</sub> = +25°C, Z<sub>S</sub> = Z<sub>L</sub> = 50 Ω

## Performance Plots – 850 MHz Application Circuit

Test conditions unless otherwise noted:  $V_S = +8\text{ V}$ ,  $R_{BIAS} = 26\ \Omega$ ,  $I_D = 118\text{ mA Typ.}$

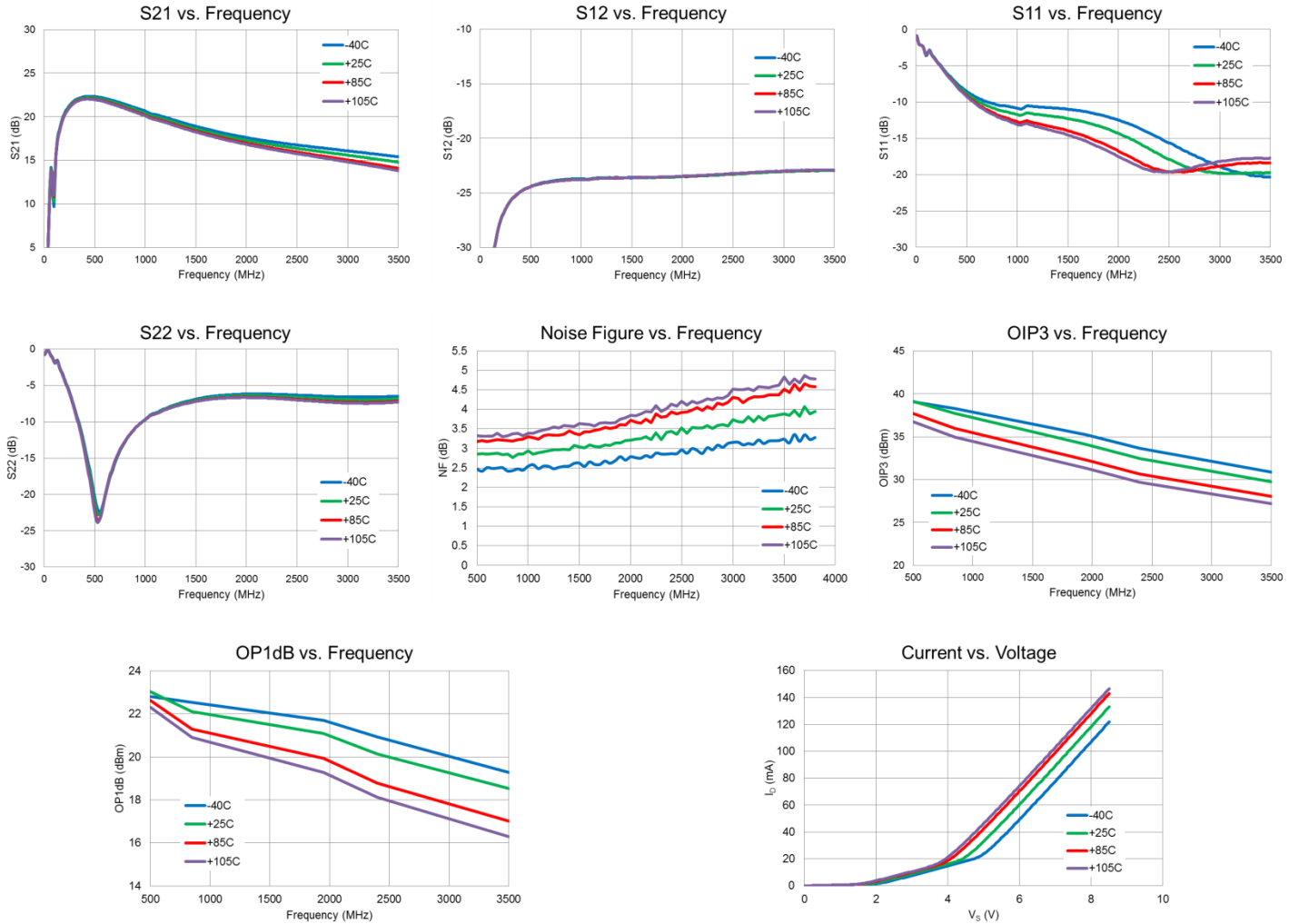

## Evaluation Board and Schematic – 850 MHz Application Circuit

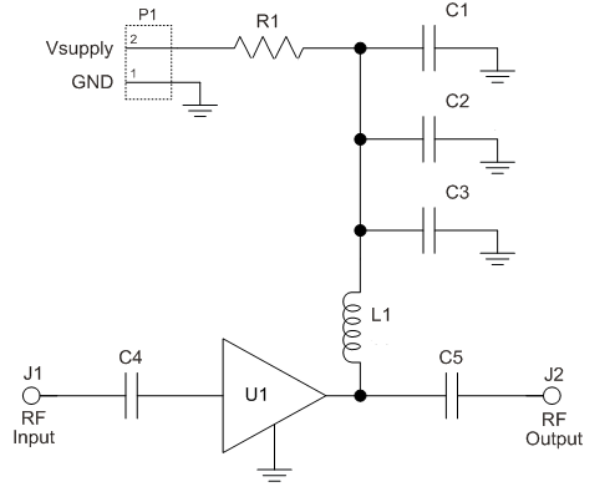
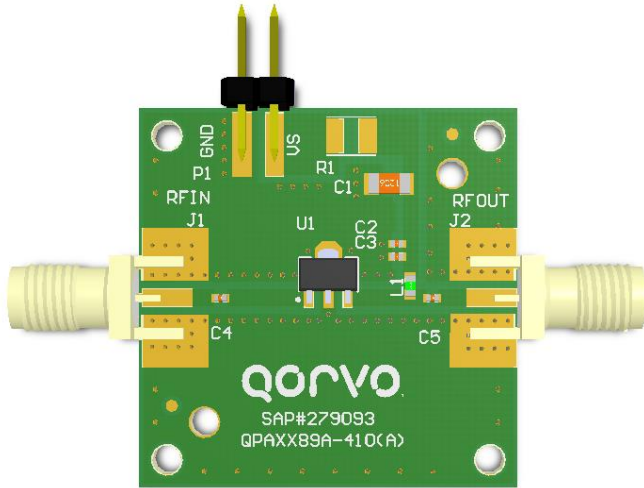

## Bill of Material – 850 MHz Application Circuit

Reference	Value	Description	Manufacturer	Part Number
n/a	n/a	PCB	Qorvo	QPAXX89X-410(A)
U1	n/a	HBT MMIC Amplifier	Qorvo	QPA7489A
C1	1 uF	CAP, 10%, 25V, X7R, 1206	Murata Electronics	GRM31MR71E105KA01L
C2	1000 pF	CAP, 10%, 50V, X7R, 0402	Murata Electronics	GRM155R71H102KA01D
C3	68 pF	CAP, 5%, 50V, C0G, 0402	Murata Electronics	GRM1555C1H680JA01D
C4, C5	100 pF	CAP, 5%, 50V, C0G, 0402	Murata Electronics	GRM1555C1H101JA01D
R1	26 Ω	RES, 5%, 1/2W, 1210	Panasonic Industrial Devices	ERJ-P14F26R1U
L1	33 nH	IND, 5%, M/L, 0603	Murata Electronics	LL1608-FSL33NJ
J1, J2	n/a	CONN, SMA, EL, FLT, 0.068" SPE-000318	Amphenol RF Asia Corp	901-10426
P1	n/a	CONN, HDR, ST, 1x2, 0.100", Hi-temp, T/H	Samtec Inc	HTSW-102-07-G-S

## Component Values for Specific Frequencies

Reference Designator	500 MHz	850 MHz	1950 MHz	2400 MHz	3500 MHz
C4, C5	220 pF	100 pF	68 pF	56 pF	39 pF
C3	100 pF	68 pF	22 pF	22 pF	15 pF
L1	68 nH	33 nH	22 nH	18 nH	15 nH

## Bias Resistor Values for Specific Supply Voltages

Reference Designator	V <sub>S</sub> =+7 V	V <sub>S</sub> =+8 V	V <sub>S</sub> =+9 V	V <sub>S</sub> =+12 V
R1 ( R <sub>BIAS</sub> ) <sup>(1,2)</sup>	17 Ω	26 Ω	35 Ω	61 Ω

**Notes:**

1. Bias resistor improves current stability over temperature
2. Bias Resistance =  $R_{BIAS} + R_{LDC} = (V_S - V_D) / I_D$

## Pin Configuration and Description

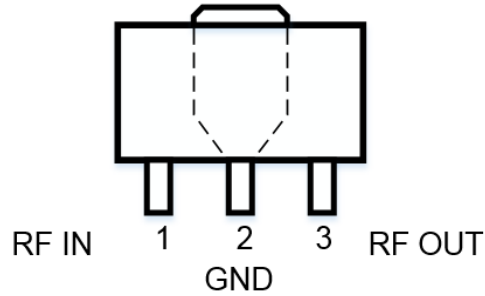

Top View

Pad No.	Label	Description
1	RF <sub>IN</sub>	RF Input Pin. DC voltage is present on this pin therefore this pin requires the use of an external DC blocking capacitor chosen for the frequency of operation.
2	GND	Connection to ground. Use via holes in PCB for best performance to reduce lead inductance as close to ground leads as possible
3	RF <sub>OUT</sub> /Bias	RF Output and Bias Pin. DC voltage is present on this pin therefore this pin requires the use of an external DC blocking capacitor chosen for the frequency of operation.
Backside Paddle	GND	Exposed area on the bottom side of the package needs to be soldered to the ground plane of the board for optimum thermal and RF performance.

## Package Marking

'Trace Code' is a 4-character Alpha-numeric code.

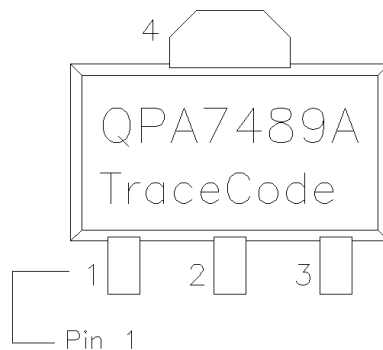

**Package Dimensions**

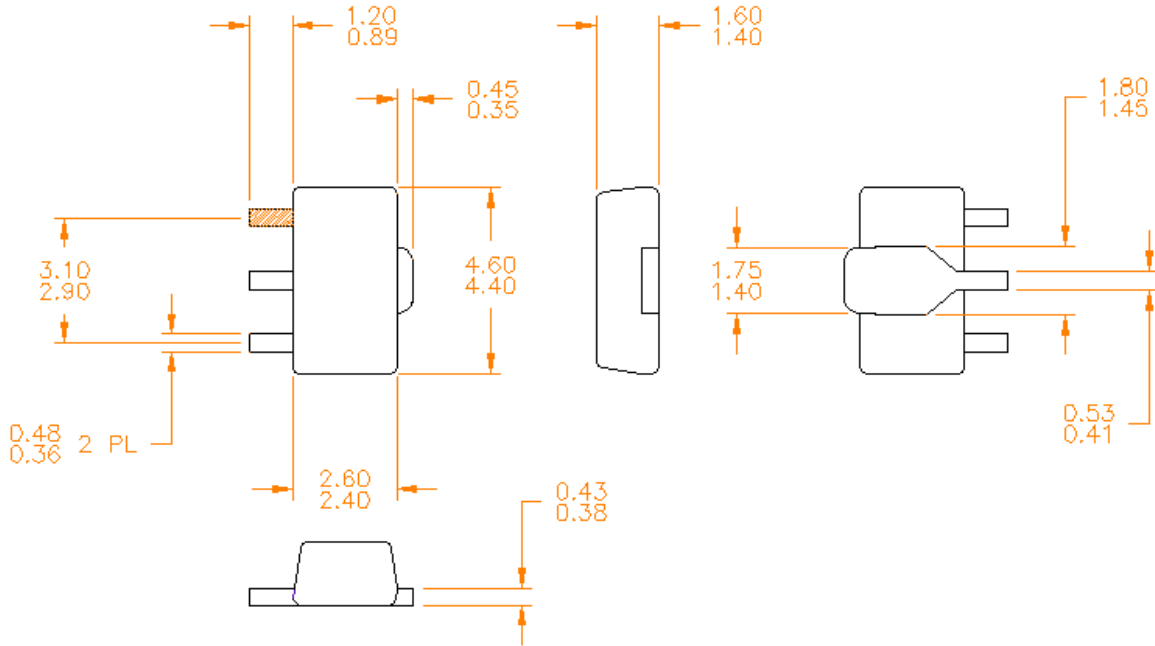

Notes:  
1. All dimensions are in millimeters. Angles are in degrees.

**PCB Mounting Pattern**

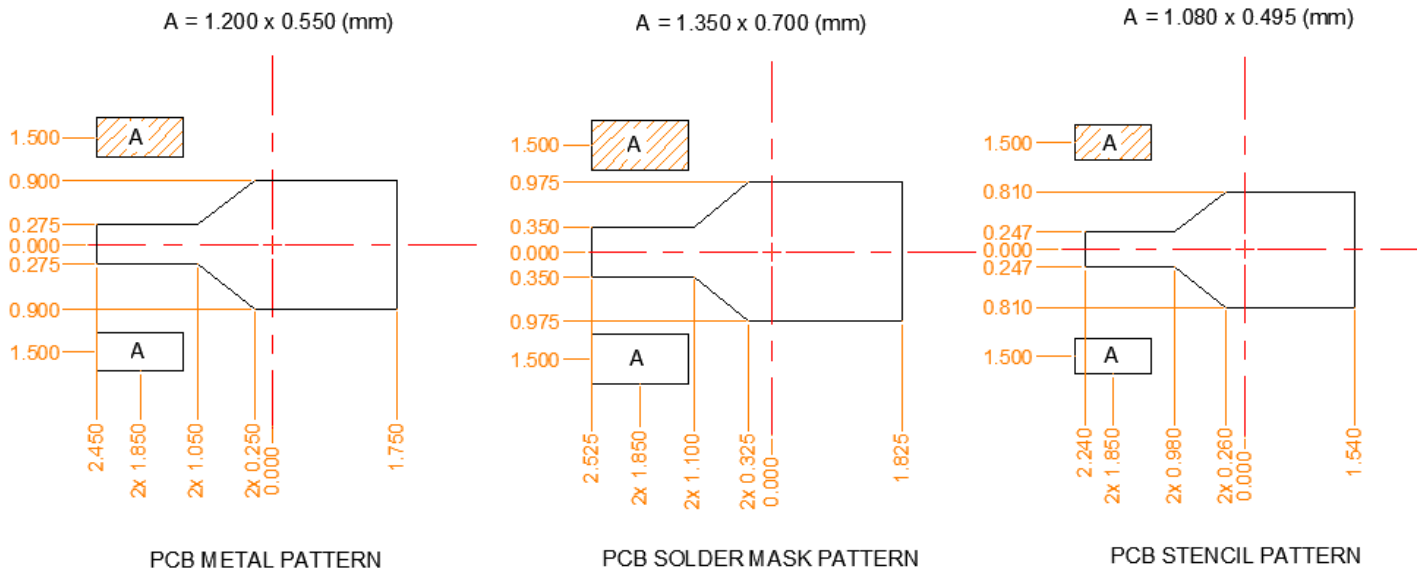

## Handling Precautions

Parameter	Rating	Standard
ESD – Human Body Model (HBM)	Class 2	ESDA / JEDEC JS-001-2014
ESD – Charged Device Model (CDM)	Class C3	ESDA / JEDEC JS-002-2014
MSL – Moisture Sensitivity Level	Level 3	IPC/JEDEC J-STD-020



Caution!  
ESD-Sensitive Device

## Solderability

Compatible with lead-free (260°C max. reflow temp.) soldering process.  
Solder profiles available upon request.

Contact plating: NiPdAu

## RoHS Compliance

This part is compliant with 2011/65/EU RoHS directive (Restrictions on the Use of Certain Hazardous Substances in Electrical and Electronic Equipment) as amended by Directive 2015/863/EU.

This product also has the following attributes:

- Lead Free
- Halogen Free (Chlorine, Bromine)
- Antimony Free
- TBBP-A (C<sub>15</sub>H<sub>12</sub>Br<sub>4</sub>O<sub>2</sub>) Free
- PFOS Free
- SVHC Free



## Contact Information

For the latest specifications, additional product information, worldwide sales and distribution locations:

**Web:** [www.qorvo.com](http://www.qorvo.com)

**Tel:** 1-844-890-8163

**Email:** [customer.support@qorvo.com](mailto:customer.support@qorvo.com)

## Important Notice

The information contained herein is believed to be reliable; however, Qorvo makes no warranties regarding the information contained herein and assumes no responsibility or liability whatsoever for the use of the information contained herein. All information contained herein is subject to change without notice. Customers should obtain and verify the latest relevant information before placing orders for Qorvo products. The information contained herein or any use of such information does not grant, explicitly or implicitly, to any party any patent rights, licenses, or any other intellectual property rights, whether with regard to such information itself or anything described by such information. **THIS INFORMATION DOES NOT CONSTITUTE A WARRANTY WITH RESPECT TO THE PRODUCTS DESCRIBED HEREIN, AND QORVO HEREBY DISCLAIMS ANY AND ALL WARRANTIES WITH RESPECT TO SUCH PRODUCTS WHETHER EXPRESS OR IMPLIED BY LAW, COURSE OF DEALING, COURSE OF PERFORMANCE, USAGE OF TRADE OR OTHERWISE, INCLUDING THE IMPLIED WARRANTIES OF MERCHANTABILITY AND FITNESS FOR A PARTICULAR PURPOSE.**

Without limiting the generality of the foregoing, Qorvo products are not warranted or authorized for use as critical components in medical, life-saving, or life-sustaining applications, or other applications where a failure would reasonably be expected to cause severe personal injury or death.

Copyright 2021 © Qorvo, Inc. | Qorvo is a registered trademark of Qorvo, Inc.

## X-ON Electronics

Largest Supplier of Electrical and Electronic Components

*Click to view similar products for [RF Amplifier](#) category:*

*Click to view products by [Qorvo](#) manufacturer:*

Other Similar products are found below :

[A82-1](#) [BGA622H6820XTSA1](#) [BGA 728L7 E6327](#) [BGB719N7ESDE6327XTMA1](#) [HMC397-SX](#) [HMC405](#) [HMC561-SX](#) [HMC8120-SX](#)  
[HMC8121-SX](#) [HMC-ALH382-SX](#) [HMC-ALH476-SX](#) [SE2433T-R](#) [SMA3101-TL-E](#) [SMA39](#) [A66-1](#) [A66-3](#) [A67-1](#) [LX5535LQ](#) [LX5540LL](#)  
[MAAM02350](#) [HMC3653LP3BETR](#) [HMC549MS8GETR](#) [HMC-ALH435-SX](#) [SMA101](#) [SMA32](#) [SMA411](#) [SMA531](#) [SST12LP19E-QX6E](#)  
[WPM0510A](#) [HMC5929LS6TR](#) [HMC5879LS7TR](#) [HMC1126](#) [HMC1087F10](#) [HMC1086](#) [HMC1016](#) [SMA1212](#) [MAX2689EWS+T](#)  
[MAAMSS0041TR](#) [MAAM37000-A1G](#) [LTC6430AIUF-15#PBF](#) [CHA5115-QDG](#) [SMA70-2](#) [SMA4011](#) [A231](#) [HMC-AUH232](#) [LX5511LQ](#)  
[LX5511LQ-TR](#) [HMC7441-SX](#) [HMC-ALH310](#) [XD1001-BD-000V](#)