

### General Description

The QPA9419 is a high-linearity two-stage power amplifier in a low-cost surface-mount package with on-chip bias control and temperature compensation circuits, suitable for small cell base station applications.

QPA9419 provides 30 dB gain and +27 dBm linear power over the 1930 – 2025 MHz frequency range which includes bands 2, 25 and 36. The amplifier is able to achieve -48 dBc ACLR at +27 dBm output power using 20 MHz LTE signal.

The QPA9419 integrates two high performance amplifier stages onto a module to allow for a compact system design and requires very few external components for operation. The amplifier is bias adjustable allowing the amplifier's power consumption to be optimized. The QPA9419 is available in a lead-free/RoHS-compliant 7 x 7 mm surface mount package.

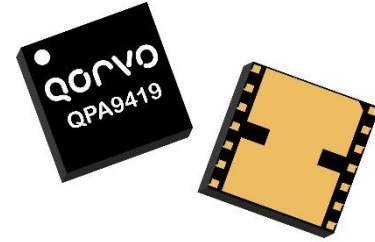

7 x 7 mm Leadless SMT Package

### Product Features

- 1930 – 2025 MHz Frequency Range
- Fully Integrated, 2 Stage Power Amplifier
- Internally Matched 50 Ω Input/Output
- -48 dBc ACLR at  $P_{avg} = +27$  dBm
- 30 dB Gain
- 14% PAE at +27 dBm
- 455 mA Quiescent Current
- On-chip Bias Control and Temp. Comp. Circuit
- Lead-free / RoHS Compliant

### Functional Block Diagram

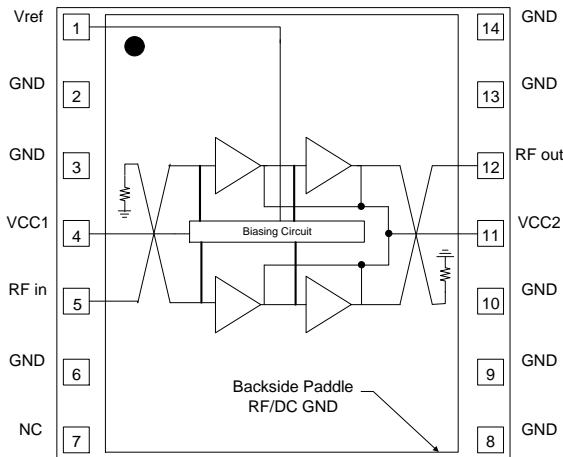

Top View

### Applications

- Small Cell / Picocell
- Enterprise Femtocell
- Customer Premises Equipment (CPE)
- Data Cards and Terminals
- Distributed Antenna Systems (DAS)
- Booster Amps, Repeaters

### Ordering Information

Part No.	Description
QPA9419	High linearity 0.5W PA
QPA9419-PCB	Evaluation Board
Standard T/R size = 2500 pieces on a 13" reel	

### Absolute Maximum Ratings

Parameter	Rating
Storage Temperature	-55 to +150 °C
Supply Voltage (V <sub>CC</sub> )	+6 V
V <sub>ref</sub>	+3.5 V
RF Input Power, CW, 50Ω, T=25°C	+13 dBm

Exceeding any one or a combination of the Absolute Maximum Rating conditions may cause permanent damage to the device. Extended application of Absolute Maximum Rating conditions to the device may reduce device reliability.

### Recommended Operating Conditions

Parameter	Min	Typ	Max	Units
V <sub>CC1</sub> , V <sub>CC2</sub>	+3.6	+4.5	+5.25	V
V <sub>ref</sub>	+2.75	+2.85	+2.95	V
T <sub>CASE</sub>	-40		+85	°C
T <sub>j</sub> at T <sub>CASE</sub> max			+163	°C

Electrical specifications are measured at specified test conditions. Specifications are not guaranteed over all recommended operating conditions.

### Electrical Specifications

Parameter	Conditions <sup>(1)</sup>	Min	Typ	Max	Units
Operational Frequency Range		1930		2025	MHz
Test Frequency			1960		MHz
Gain		27	30	32	dB
Input Return Loss			20		dB
Output Return Loss			18		dB
P1dB			36		dBm
ACLR	P <sub>OUT</sub> = +27dBm, 20 MHz LTE E-TM1.1, 9.5dB PAR		-48	-45	dBc
Power Added Efficiency	P <sub>OUT</sub> = +27dBm, 20 MHz LTE E-TM1.1, 9.5dB PAR	13	14		%
Quiescent Current, I <sub>CCQ</sub> <sup>2</sup>	V <sub>CC1</sub> + V <sub>CC2</sub>	330	415	510	mA
Leakage Current	V <sub>CC</sub> = +4.5 V, V <sub>ref</sub> = 0 V		3	10	μA
Reference Current, I <sub>ref</sub>	V <sub>ref</sub> = +2.85V		15	19.5	mA
Operational Current, I <sub>CC</sub>	P <sub>out</sub> = +27 dBm		800	900	mA
Switching Speed	Rise time (10%-90%)		575		ns
	Fall time (90%-10%)		1580		ns
Spurious Output Level	P <sub>out</sub> ≤ +27dBm, In & Out of band load VSWR ≤ 10:1		-60		dBc
VSWR survivability	No permanent degradation or failure	10:1			-
Harmonics	2F <sub>0</sub> (P <sub>out</sub> = 27 dBm)		-44	-39	dBc
	3F <sub>0</sub> (P <sub>out</sub> = 27 dBm)		-57	-52	dBc
	4F <sub>0</sub> (P <sub>out</sub> = 27 dBm)		-57	-52	dBc
Thermal Resistance, θ <sub>jc</sub>	Module (junction to case)			18.5	°C/W

Notes:

1. Test conditions unless otherwise noted: V<sub>CC1</sub> = V<sub>CC2</sub> = +4.5 V, V<sub>ref</sub> = +2.85V, Temp = +25 °C, 50 Ω system.
2. Current through V<sub>CC1</sub> does not vary with power. V<sub>CC1</sub> provides the bias voltage to the current mirror circuit along with V<sub>ref</sub> to set the bias point for the whole amplifier.

### Evaluation Board

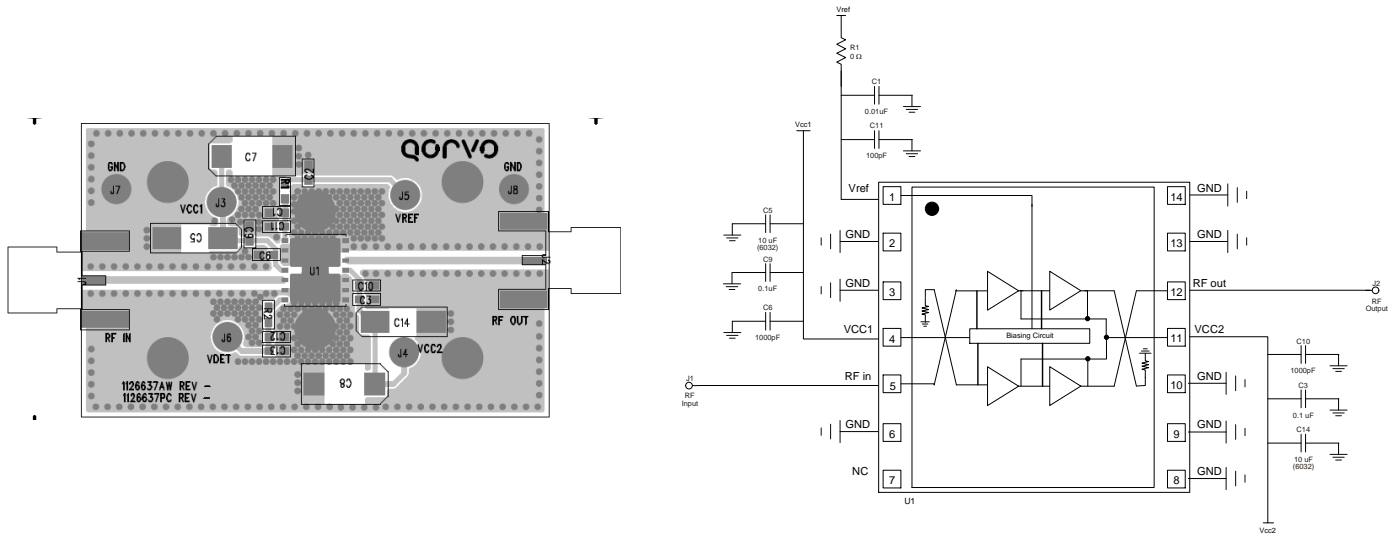

### Bill of Material – Evaluation Board

Reference Des.	Value	Description	Manuf.	Part Number
n/a	n/a	Printed Circuit Board		
U1	n/a	High Linearity 0.5 W Power Amplifier	Qorvo	QPA9419
R1	0 Ω	Resistor, Chip, 0603, 5%	various	
C1	0.01 uF	Capacitor, Chip, 0603, 5%	various	
C11	100 pF	Capacitor, Chip, 0603, 5%	various	
C3, C9	0.1 uF	Capacitor, Chip, 0603, 5%	various	
C5, C14	10 uF	Capacitor, Chip, 6032, 10%, Tantalum	various	
C6, C10	1000 pF	Capacitor, Chip, 0603, NPO/COG, 5%	various	

### Performance Plots

Test conditions unless otherwise noted:  $V_{CC1} = V_{CC2} = +4.5V$ ,  $V_{ref} = +2.85V$ ,  $Temp. = +25^\circ C$

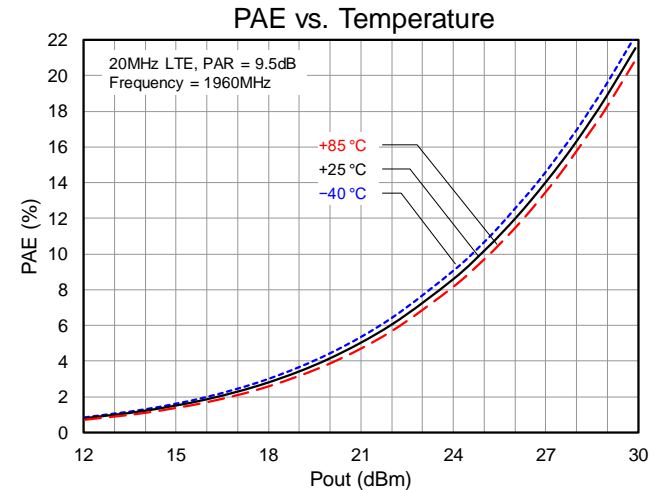
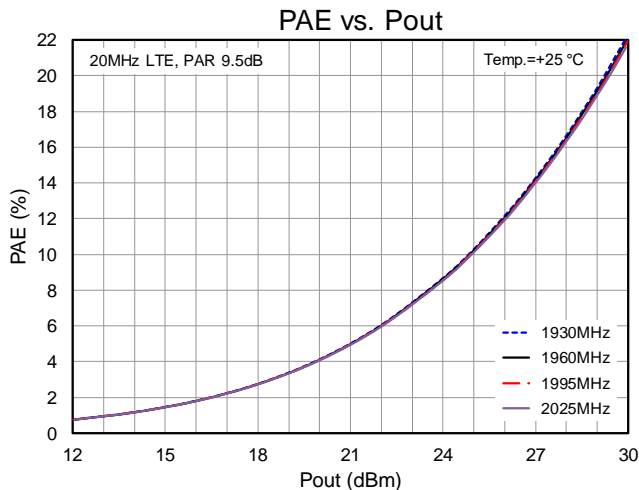
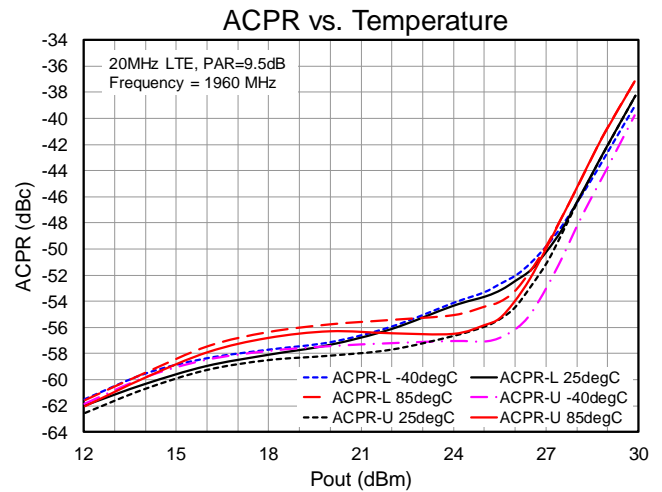
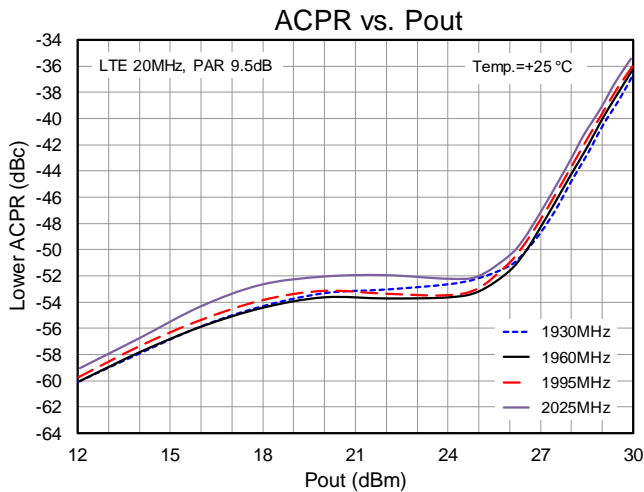
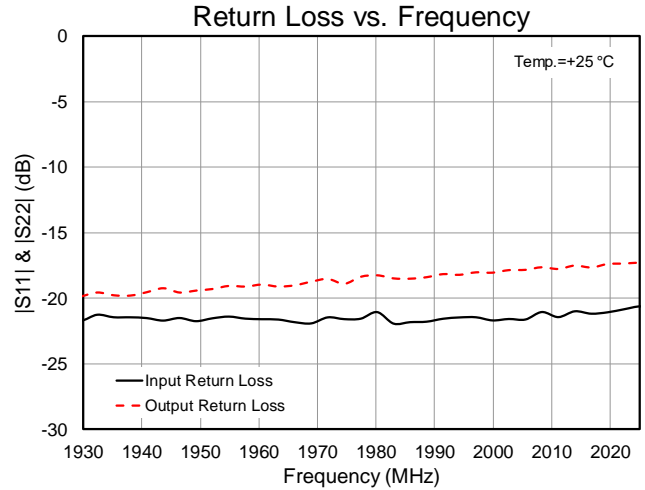
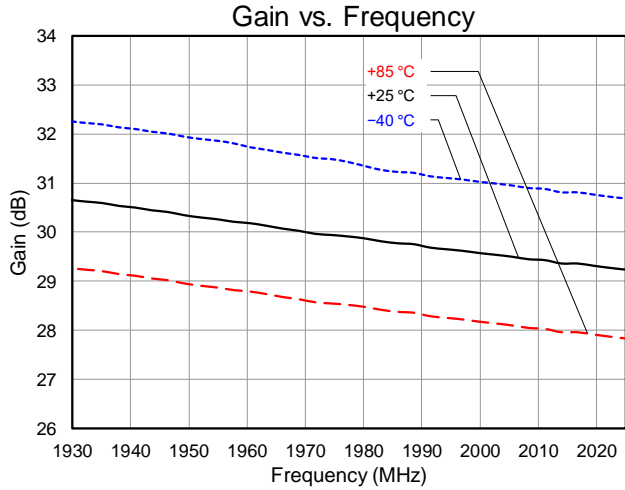

## Pin Configuration and Description

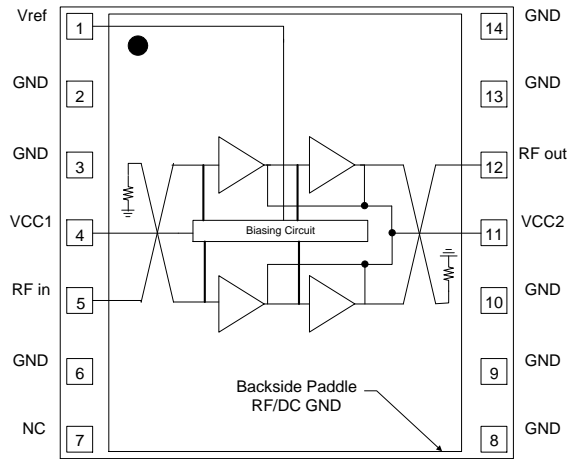

Top View

Pad No.	Label	Description
1	Vref	Provides reference voltage for internal active biasing circuit
2, 3, 6, 8, 9, 10, 13, 14	GND	RF and DC ground.
4	VCC1	Bias voltage for current mirror in combination with Vref to set the bias point.
5	RFin	RF input pin. The DC is internally blocked at this pin.
7	NC	No internal connection. Can be left open or grounded for mounting integrity.
11	VCC2	Supply to all stages.
12	RFout	RF output pin. The DC is internally blocked at this pin.
Backside Paddle	RF/DC GND	RF/DC ground. See PCB Mounting Pattern for suggested footprint.

## Evaluation Board PCB Information

### Qorvo PCB 1126637 Material and Stack-up

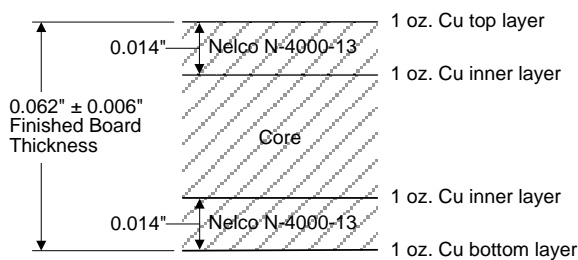

50 ohm line dimensions: width = .028"  
spacing = .028".

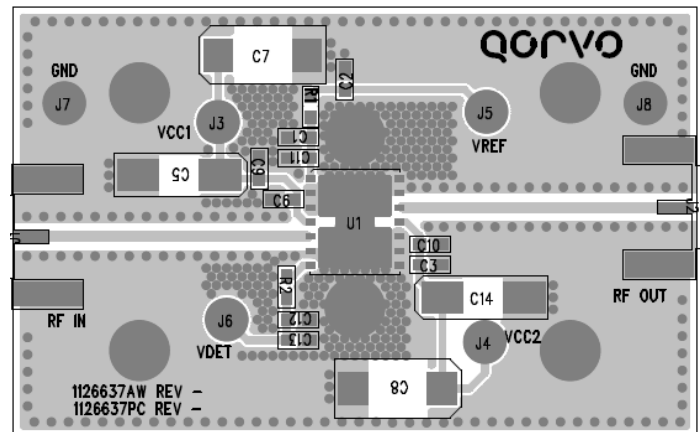

### Package Marking and Dimensions

Marking: Part Number – QPA9419  
Trace Code – XXXX

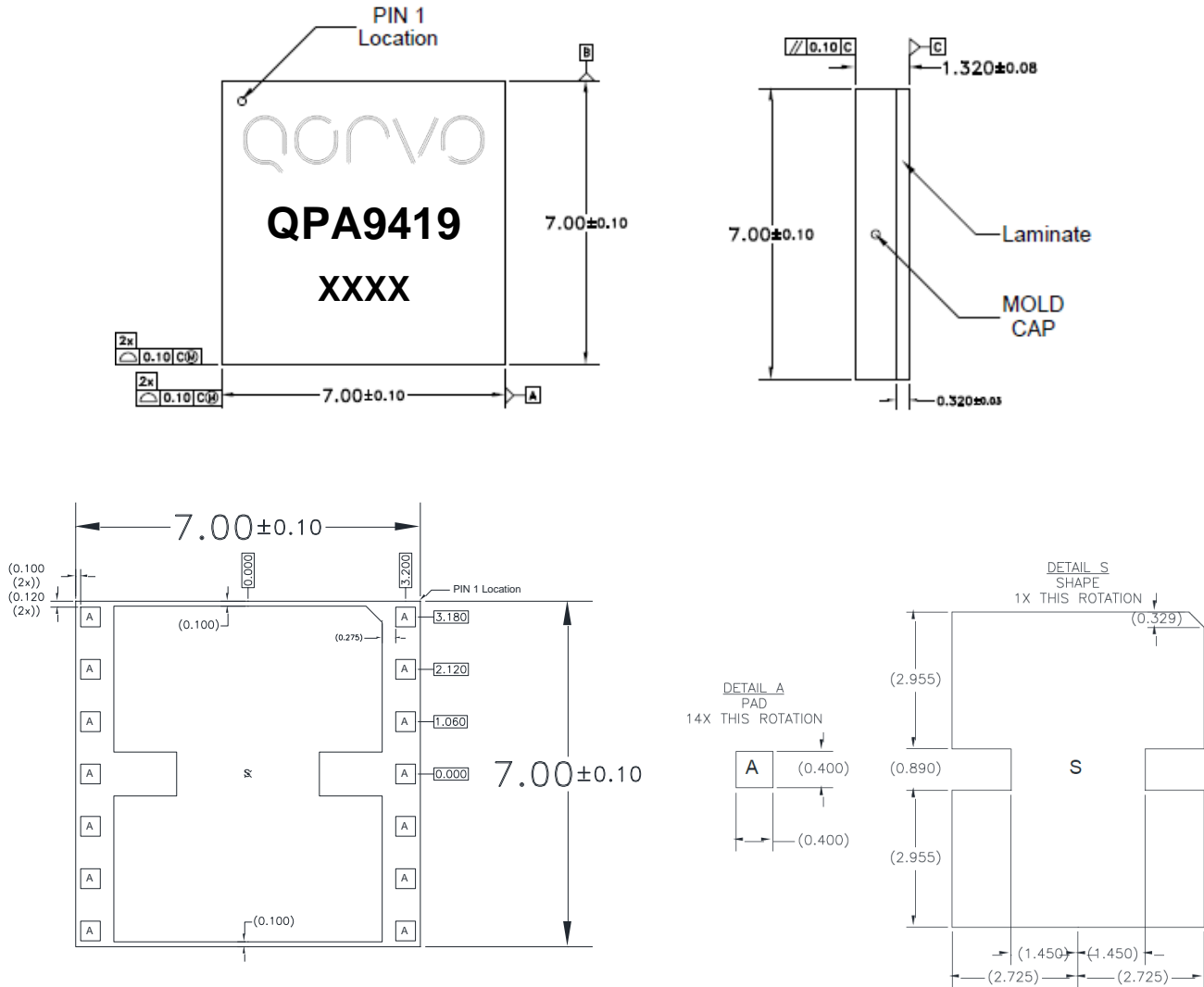

- Notes:
1. All dimensions are in millimeters. Angles are in degrees.
  2. The terminal #1 identifier and terminal numbering conform to JESD 95-1 SPP-012.
  3. Contact plating: NiPdAu

### PCB Mounting Pattern

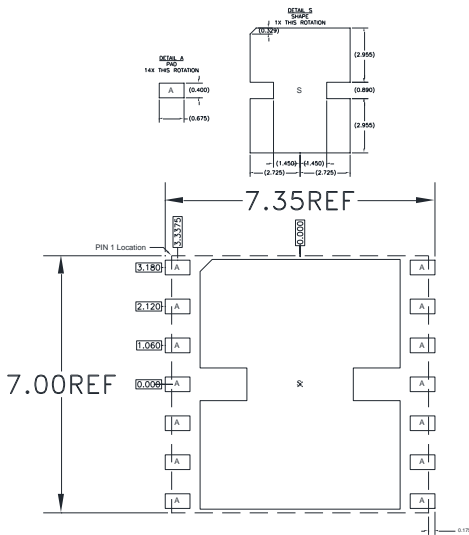

**RECOMMENDED  
LAND PATTERN**

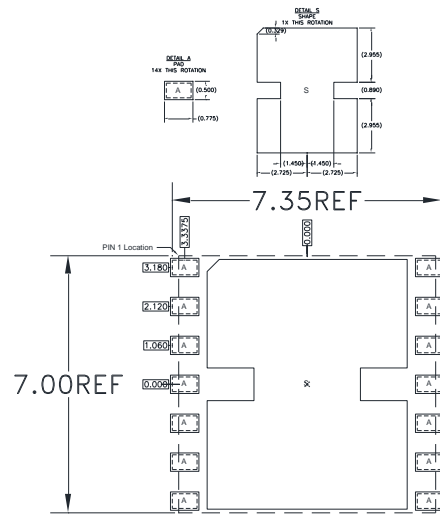

**RECOMMENDED  
LAND PATTERN MASK**

**Notes:**

1. All dimensions are in millimeters. Angles are in degrees.
2. Use 1 oz. copper minimum for top and bottom layer metal.
3. Vias are required under the backside paddle of this device for proper RF/DC grounding and thermal dissipation. We recommend a 0.35mm (#80/.0135") diameter bit for drilling via holes and a final plated thru diameter of 0.25 mm (0.10").
4. Ensure good package backside paddle solder attach for reliable operation and best electrical performance.

## Handling Precautions

Parameter	Rating	Standard
ESD – Human Body Model (HBM)	Class 2	ESDA / JEDEC JS-001-2012
ESD – Charged Device Model (CDM)	Class C3	JEDEC JESD22-C101F
MSL – Moisture Sensitivity Level	Level 3	IPC/JEDEC J-STD-020



Caution!  
ESD-Sensitive Device

## Solderability

Compatible with both lead-free (260°C max. reflow temp.) and tin/lead (245°C max. reflow temp.) soldering processes.

Solder profiles available upon request.

Contact plating: Electrolytic plated Au over Ni

## RoHS Compliance

This part is compliant with the 2011/65/EU RoHS directive (Restrictions on the Use of Certain Hazardous Substances in Electrical and Electronic Equipment) as amended by Directive 2015/863/EU. This product also has the following attributes:

- Product uses RoHS Exemption 7c-I to meet RoHS Compliance requirements.
- Halogen Free (Chlorine, Bromine)
- Antimony Free
- TBBP-A (C<sub>15</sub>H<sub>12</sub>Br<sub>4</sub>O<sub>2</sub>) Free
- PFOS Free

## Contact Information

For the latest specifications, additional product information, worldwide sales and distribution locations:

**Web:** [www.qorvo.com](http://www.qorvo.com)

**Tel:** 1-844-890-8163

**Email:** [customer.support@qorvo.com](mailto:customer.support@qorvo.com)

## Important Notice

The information contained herein is believed to be reliable; however, Qorvo makes no warranties regarding the information contained herein and assumes no responsibility or liability whatsoever for the use of the information contained herein. All information contained herein is subject to change without notice. Customers should obtain and verify the latest relevant information before placing orders for Qorvo products. The information contained herein or any use of such information does not grant, explicitly or implicitly, to any party any patent rights, licenses, or any other intellectual property rights, whether with regard to such information itself or anything described by such information. **THIS INFORMATION DOES NOT CONSTITUTE A WARRANTY WITH RESPECT TO THE PRODUCTS DESCRIBED HEREIN, AND QORVO HEREBY DISCLAIMS ANY AND ALL WARRANTIES WITH RESPECT TO SUCH PRODUCTS WHETHER EXPRESS OR IMPLIED BY LAW, COURSE OF DEALING, COURSE OF PERFORMANCE, USAGE OF TRADE OR OTHERWISE, INCLUDING THE IMPLIED WARRANTIES OF MERCHANTABILITY AND FITNESS FOR A PARTICULAR PURPOSE.**

Without limiting the generality of the foregoing, Qorvo products are not warranted or authorized for use as critical components in medical, life-saving, or life-sustaining applications, or other applications where a failure would reasonably be expected to cause severe personal injury or death.

Copyright 2020 © Qorvo, Inc. | Qorvo is a registered trademark of Qorvo, Inc.



## X-ON Electronics

Largest Supplier of Electrical and Electronic Components

*Click to view similar products for [RF Amplifier](#) category:*

*Click to view products by [Qorvo](#) manufacturer:*

Other Similar products are found below :

[A82-1](#) [BGA622H6820XTSA1](#) [BGA 728L7 E6327](#) [BGB719N7ESDE6327XTMA1](#) [HMC397-SX](#) [HMC405](#) [HMC561-SX](#) [HMC8120-SX](#)  
[HMC8121-SX](#) [HMC-ALH382-SX](#) [HMC-ALH476-SX](#) [SE2433T-R](#) [SMA3101-TL-E](#) [SMA39](#) [A66-1](#) [A66-3](#) [A67-1](#) [LX5535LQ](#) [LX5540LL](#)  
[MAAM02350](#) [HMC3653LP3BETR](#) [HMC549MS8GETR](#) [HMC-ALH435-SX](#) [SMA101](#) [SMA32](#) [SMA411](#) [SMA531](#) [SST12LP17E-XX8E](#)  
[SST12LP19E-QX6E](#) [WPM0510A](#) [HMC5929LS6TR](#) [HMC5879LS7TR](#) [HMC1126](#) [HMC1087F10](#) [HMC1086](#) [HMC1016](#) [SMA1212](#)  
[MAX2689EWS+T](#) [MAAMSS0041TR](#) [MAAM37000-A1G](#) [LTC6430AIUF-15#PBF](#) [CHA5115-QDG](#) [SMA70-2](#) [SMA4011](#) [A231](#) [HMC-](#)  
[AUH232](#) [LX5511LQ](#) [LX5511LQ-TR](#) [HMC7441-SX](#) [HMC-ALH310](#)